

Anonyme. The Journal of physical chemistry. Published at Cornell university [3puis3 Published under the auspices of the American chemical society, the Chemical society and the Faraday society]. 1896 [!]-. 1912.

1/ Les contenus accessibles sur le site Gallica sont pour la plupart des reproductions numériques d'oeuvres tombées dans le domaine public provenant des collections de la BnF. Leur réutilisation s'inscrit dans le cadre de la loi n°78-753 du 17 juillet 1978 :

\*La réutilisation non commerciale de ces contenus est libre et gratuite dans le respect de la législation en vigueur et notamment du maintien de la mention de source.

\*La réutilisation commerciale de ces contenus est payante et fait l'objet d'une licence. Est entendue par réutilisation commerciale la revente de contenus sous forme de produits élaborés ou de fourniture de service.

Cliquer [ici](#) pour accéder aux tarifs et à la licence

2/ Les contenus de Gallica sont la propriété de la BnF au sens de l'article L.2112-1 du code général de la propriété des personnes publiques.

3/ Quelques contenus sont soumis à un régime de réutilisation particulier. Il s'agit :

\*des reproductions de documents protégés par un droit d'auteur appartenant à un tiers. Ces documents ne peuvent être réutilisés sauf dans le cadre de la copie privée sans l'autorisation préalable du titulaire des droits.

\*des reproductions de documents conservés dans les bibliothèques ou autres institutions partenaires. Ceux-ci sont signalés par la mention Source Gallica.BnF.fr / Bibliothèque municipale de ... (ou autre partenaire). L'utilisateur est invité à s'informer auprès de ces bibliothèques de leurs conditions de réutilisation.

4/ Gallica constitue une base de données, dont la BnF est producteur, protégée au sens des articles L341-1 et suivants du code la propriété intellectuelle.

5/ Les présentes conditions d'utilisation des contenus de Gallica sont régies par la loi française. En cas de réutilisation prévue par un autre pays, il appartient à chaque utilisateur de vérifier la conformité de son projet avec le droit de ce pays.

6/ L'utilisateur s'engage à respecter les présentes conditions d'utilisation ainsi que la législation en vigueur, notamment en matière de propriété intellectuelle. En cas de non respect de ces dispositions, il est notamment passible d'une amende prévue par la loi du 17 juillet 1978.

7/ Pour obtenir un document de Gallica en haute définition, contacter [reutilisation@bnf.fr](mailto:reutilisation@bnf.fr).

***Journal of physical  
chemistry***

**Tome 16**

**Volume 16**

***Washington* 1912**



**ANNUE**



CPg4

THE JOURNAL  
OF  
PHYSICAL CHEMISTRY

*Editor*

WILDER D. BANCROFT

*Associate Editors*

H. T. BARNES  
S. L. BIGELOW  
F. K. CAMERON  
E. C. FRANKLIN

G. A. HULETT  
L. KAHLBERG  
W. L. MILLER  
J. L. R. MORGAN

T. B. ROBERTSON  
H. SCHLUNDT  
E. P. SCHOCH  
J. W. WALKER

VOLUME XVI

ITHACA, N. Y.

THE EDITOR

LEIPZIG: BERNH. LIEBISCH (K. F. Koehler's Antiquarium)  
for the continent of Europe

1912



CONTENTS OF VOLUME XVI

1. JANUARY

Arden R. Johnson,	A Study of Organic Boro-Nitrogen Compounds,	1
Wilder D. Bancroft,	The Photographic Plate VII,	29
D. Tyrer,	The Theory of Solubility,	69
New Books,		86

2. FEBRUARY

Wilder D. Bancroft,	The Photographic Plate VIII,	89
G. D. Kratz,	Colloidal Ferric Oxide,	126
Herman C. Allen,	The Reduction of Nitrobenzene by means of Ferrous Hydroxide,	131
New Books,		170

3. MARCH

Wilder D. Bancroft,	The Theory of Emulsification, I,	177
M. M. Garver,	A New Method of Determining the Range of Molecular Action,	234
E. F. Farnau,	Electrolytic Reduction of Nitrobenzene without a Diaphragm,	249
Herman Schlundt and O. C. Schaefer,	The Dielectric Constant of Liquid Arsine,	253
New Books,		255

4. APRIL

Herbert N. McCoy and Franklin L. West,	The Physical and Chemical Properties of Some In- organic Amalgams,	261
C. W. Bennett,	A Rotating Cathode,	287
C. W. Bennett,	Tensile Strength of Electrolytic Copper on a Rotating Cathode,	294
Wilder D. Bancroft,	Electrical Endosmose,	312
F. E. Bartell,	Pore Diameters of Osmotic Membranes,	318
New Books,		336

5. MAY

Wilder D. Bancroft,	The Theory of Emulsification, II,	345
George W. Heise,	Equilibrium in Systems consisting of Lead Halides and Pyridine,	373
T. Brailsford Robertson,	Studies in the Electrochemistry of the Proteins, VIII. The Dissociation of Solutions of the Sulphate and Chloride of Protamin (Salmin),	382
Wilder D. Bancroft,	The Action of Water Vapor on Gelatine,	395
George J. Sargent,	The Decomposition of Bromoform,	407
M. M. Feldstein,	On a Device for Measuring Transparency,	421
New Books,		423

## 6. JUNE

G. Hevesy,	On the Solubility of Actinium Emanation in Liquids and in Charcoal, . . . . .	429
G. Hevesy,	The Detection of Actinium in Solutions of Minerals, . . . . .	451
M. M. Garver,	On a Thermodynamic Measure of the Degree of Polymerization of Liquid Substances, . . . . .	454
M. M. Garver,	A Note on the Molecular Attraction in Liquids and in Liquid Films, . . . . .	471
Wilder D. Bancroft,	The Theory of Emulsification, III, . . . . .	475
Frank B. Kenrick,	Some Lecture Experiments on Surface Tension, . . . . .	513
Frank B. Kenrick,	Lantern Experiments on Reactions in Non-homogeneous Systems, . . . . .	519
New Books,		527

## 7. OCTOBER

Wilder D. Bancroft, George E. Grant and Arthur S. Elsenbast,	The Permanency of Paintings, . . . . .	529
Wilder D. Bancroft, S. C. Lind,	Rapid Testing of Dyes and Pigments, . . . . .	546
	The Photochemical Oxidation of Benzene, . . . . .	556
	On the Nature of the Chemical Action produced by $\alpha$ Particles and the Probable Role Played by Ions, . . . . .	564
Charles W. Bennett,	Glycerol as Sensitizer, . . . . .	614
New Books,		616

## 8. NOVEMBER

F. F. Fitzgerald,	The Electrical Conductivity of Solutions in Methylamine and Ethylamine; the Fluidity of Ammonia, Methylamine, and Sulphur Dioxide, and the Fluidity of Certain Solutions in these Solvents, . . . . .	621
Arthur S. Elsenbast and George E. Grant, M. M. Garver,	The Second Positive, . . . . .	662
	On the Polymerization of Liquids and a General Method for Determining Its Relative Value, . . . . .	669
M. M. Garver,	A Supplementary Note on a Thermodynamic Measure of Polymerization, . . . . .	679
Edward Curtis Franklin,	The Action of Potassium Amide on Thallium Nitrate in Liquid Ammonia Solutions, . . . . .	682
New Books,		704

## 9. DECEMBER

Paul C. Freer and H. D. Gibbs,	Sunlight, . . . . .	709
Wilder D. Bancroft,	The Theory of Emulsification, IV, . . . . .	739
C. J. Lynde,	Osmosis in Soils, I, . . . . .	759

*Contents of Volume XVI*

iii

<b>C. J. Lynde and F. W. Bates, C. W. Bennett, New Books, Name Index, Index to New Books, Subject Index,</b>	<b>Osmosis in Soils, II, . . . . .</b>	<b>766</b>
	<b>Photochemical Reduction of Copper Sulphate, . . . . .</b>	<b>782</b>
		<b>786</b>
		<b>793</b>
		<b>795</b>
		<b>797</b>





## A STUDY OF ORGANIC BORO-NITROGEN COMPOUNDS

BY ARDEN RICHARD JOHNSON

### Chemical Relationship of Boron and Nitrogen

A review of the binary compounds of boron thus far synthesized, and a study of the many unsuccessful attempts to form other compounds reveals the fact that there are but few elements which combine readily with this peculiar element. Though itself essentially a non-metal, boron combines under ordinary conditions, with but few metals to form metallic borides. As the number of strictly non-metallic elements is small compared with the number of metals named in the periodic system the number of binary compounds of boron appears quite limited. Among this limited number of compounds of boron with non-metals, which are fairly readily formed, we naturally recognize the preeminent importance and rôle of the oxide,  $B_2O_3$ .

But after the important oxygen compound, and also before the interesting halides, it appears that the strong mutual attraction between boron and nitrogen is of special interest and importance. By passing nitrogen over hot boron the nitride of boron,  $B \equiv N$ , forms. This is an extremely stable compound, as is evident from its behavior at high temperatures and toward the most powerful oxidizing agents. Not only do these elements combine directly, but boron nitride is one of the main products formed whenever a boron compound, like boric oxide or borax, is brought into intimate contact with almost any nitrogen compound at a fairly high temperature.

A glance at the periodic system shows that boron and nitrogen are in the same period—the first period (and only series) of the periodic system of the elements. Carbon, which is practically always tetravalent, stands in the middle group, with boron just preceding it. The latter is generally trivalent, though it has pentavalent possibilities. Nitrogen

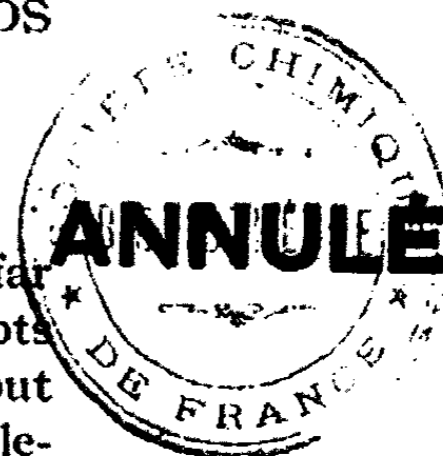

immediately follows boron, with a valence that is usually three but probably five in many cases. In passing along the series from left to right there is as rapid a change in properties, both chemical and physical, as is found in any series in the periodic system. And so boron and nitrogen, two elements symmetrically placed in the periodic system with respect to each other nevertheless exhibit sufficient chemical and physical dissimilarities to insure their power to unite to form a firm chemical compound.

The above considerations caused the writer to look for so-called "molecular" compounds formed by the direct union of a boron compound with a nitrogen compound. Such molecular compounds would result from the "residual attractions" of boron and nitrogen. A review of the literature brought to light several addition-compounds of ammonia and certain halides of boron. These substances were, for the most part, prepared by Moissan's students. Following is a complete description of their work:

*Compounds of  $BI_3$  with  $NH_3$ .*—There is at least one definite compound of ammonia and the iodide of boron (prepared by Besson<sup>1</sup>) which has the formula  $BI_3 \cdot 5NH_3$ . Dry gaseous ammonia combines directly with  $BI_3$  with disengagement of much heat; and if the reaction is not moderated by cooling, there is formed as a secondary product, an insoluble substance, namely,  $BN$ . In practice the  $BI_3$  is dissolved in  $CCl_4$  and maintained at about  $0^\circ$ , while dry ammonia gas, also chilled to  $0^\circ$ , is slowly conducted through the solution. There is formed immediately a white solid on the surface of the  $CCl_4$ , and when the reaction is terminated, the solvent is expelled with a current of dry air at a temperature of  $50^\circ$ – $60^\circ$ . Thus an amorphous, white solid, corresponding to the composition above indicated, is obtained.

<sup>1</sup> Besson: *Comptes rendus*, 110, 80 (1890).

## ANALYSIS

I	II	Theoretical for $BI_3 \cdot 5NH_3$
NH <sub>3</sub> 17.37	17.55	17.82
I 80.32	79.35	79.85
(Diff.) B 2.31	3.10	2.30

*Properties of  $BI_3 \cdot 5NH_3$ .*—In light the compound slowly turns yellow and iodine is set free; it is also readily decomposed by water. When heated in a current of hydrogen, iodine is set free.

*Other Compounds of  $BI_3$  with  $NH_3$ .*—Very interesting is the fact, also observed by Besson, that if the compound  $BI_3 \cdot 5NH_3$  is maintained in a current of dry ammonia gas, it absorbs the latter rapidly. The mass first becomes pasty, and if the process is continued to saturation at 0° the whole becomes liquid. It is stated that its composition is about  $BI_3 \cdot 15NH_3$  at 0° but no analytical figures are given. Even at 0°, this liquid substance is not stable; furthermore it loses gas in a current of dry hydrogen and after a time it attains the composition of  $BI_3 \cdot 5NH_3$ .

*Compounds of  $BBr_3$  with  $NH_3$ .*—There appears to be but one definite compound of ammonia and the bromide of boron. This has also been prepared by Besson. Dry, gaseous ammonia, conducted into a solution of  $BBr_3$  dissolved in carbon tetrachloride, precipitates a beautiful snow-white mass, which, when treated as described for the iodine ammonia compound is found to have a composition corresponding to  $BBr_3 \cdot 4NH_3$ .

## ANALYSIS

I	II	Theoretical for $BBr_3 \cdot 4NH_3$
NH <sub>3</sub> 21.61	21.42	21.31
Br 74.35	74.60	75.23
(Diff.) B 4.04	3.98	3.46



When maintained at  $10^{\circ}$  in a current of dry ammonia gas, the compound absorbs a quantity of ammonia corresponding to  $\frac{1}{2}$   $\text{NH}_3$  for every  $\text{BBr}_3 \cdot 4\text{NH}_3$ ; but the absorption appears to be of a purely physical nature, because the ammonia is easily carried away again by a current of dry air. If the  $\text{BBr}_3 \cdot 4\text{NH}_3$  is heated progressively in a current of dry hydrogen, it begins to decompose at  $150^{\circ}$  and to sublime. The products of the decomposition are BN and ammonium bromide. Water or alkalis decompose  $\text{BBr}_3 \cdot 4\text{NH}_3$ .

*Compound of  $\text{BCl}_3$  with  $\text{NH}_3$ .*—The reactions between dry ammonia and the chloride of boron have been the object of several researches, first among which was Berzelius<sup>1</sup>, which indicated that the compound  $2\text{BCl}_3 \cdot 3\text{NH}_3$  is formed. Later the work of Berzelius was confirmed by that of Martius,<sup>2</sup> who formed a compound of the same composition. Martius conducted dry ammonia gas directly into well cooled liquid  $\text{BCl}_3$ , without the use of any solvent for the latter. He described the reaction as taking place with very great evolution of heat. When saturated with ammonia, there was obtained a fine, white, crystalline powder, *which did not fume in the air* (?). On heating the product in water, it decomposed into ammonium chloride, boric acid and hydrochloric acid, and when heated in a tube it sublimed unchanged. But if placed in a hot tube through which ammonia gas was conducted BN resulted as the principal product.

Martius' analytical results are as follows:

- No. (1) 1.0420 gram of the compound gave 3.1335 gram  $\text{AgCl}$ ,  
74.33 percent  $\text{Cl}$ .  
No. (2) 0.8646 gram of the compound gave 2.6032 gram  $\text{AgCl}$ ,  
74.49 per cent  $\text{Cl}$ .  
0.8990 gram of the compound gave 2.086 gram of ammonium platinum chloride: representing 17.77 percent  $\text{NH}_3$ .

These figures correspond to the formula  $2\text{BCl}_3 \cdot 3\text{NH}_3$ , which was also obtained by Berzelius.

*Other Compounds of  $\text{BCl}_3$  with  $\text{NH}_3$ .*—It has already been

<sup>1</sup> Berzelius: Pogg. Ann., 2, 113-147 (1824).

<sup>2</sup> Martius: Liebig's Ann., 109, 80 (1859).

mentioned that in the case of the iodide of boron Besson obtained a liquid of high ammonia content by saturating  $\text{BI}_3$  with ammonia at  $0^\circ$ . Likewise, in operating at  $8^\circ$  he showed that two molecules of  $\text{BCl}_3$  absorb nine molecules of ammonia, and concluded that the compound  $2\text{BCl}_3 \cdot 9\text{NH}_3$  is thus formed. Besson also claims that  $2\text{BCl}_3$  react with  $15\text{NH}_3$  to form  $\text{NH}_4\text{Br}$  and a mixture of amides and imides of boron. His evidence is based on manometric data for the dissociation tension of the products obtained at  $-23^\circ$ . This work will be referred to again in the discussion further along under "Amides and Imides of Boron."

*Compounds of  $\text{BF}_3$  with  $\text{NH}_3$ .*—After diligently searching the literature of boron and fluorine I have, as yet, failed to find any compound mentioned which has been formed by the interaction of the fluoride of boron and ammonia, nor does it appear that any attempts to prepare such compounds have been described.

*Retrospect of Compounds of Boro-Halides with  $\text{NH}_3$ .*—It is interesting to arrange these compounds of ammonia and the halides of boron in columns and series in the order of atomic weights of the halogens and content of ammonia or nitrogen, as follows:

Atomic weight of halogen	126.92	79.92	35.46	19.00
Series	$\text{BI}_3$	$\text{BBr}_3$	$\text{BCl}_3$	$\text{BF}_3$
I	$\text{BI}_3 \cdot 5\text{NH}_3$	$\text{BBr}_3 \cdot 4\text{NH}_3$	$\text{BCl}_3 \cdot \frac{3}{2}\text{NH}_3$	—
II	—	—	$\text{BCl}_3 \cdot \frac{9}{2}\text{NH}_3$	—
III	$\text{BI}_3 \cdot 15\text{NH}_3$	—	$\text{BCl}_3 \cdot \frac{15}{2}\text{NH}_3$	—

This table shows that, in the series of simplest combinations, the capacity of the boro-halide for ammonia rapidly falls off with the decrease in the atomic weight of the halogen. While, of course, it is unsafe to attempt broad conclusions from such meager data, still, it appears that we might reasonably expect no compound of ammonia and the boride of fluorine, or at least, one containing but a very small proportion of ammonia.

That the foregoing molecular compounds offer problems in valency which are practically insoluble at the present time is quite evident; it is indeed remarkable how a single molecule like  $\text{BI}_3$ , with only two subordinate valencies, so far as we know, can bind to itself so many molecules of another compound. There is without doubt an exercise of deep mutual *residual* attractions, perhaps mainly between boron and nitrogen.

*The Amides and Imides of Boron.*—In those compounds of the halides of boron with several molecules of ammonia it would seem quite possible to obtain amides and also imides by cleverly splitting off the halide of hydrogen. While no one appears to have attempted this by ordinary chemical means, still Joannis<sup>1</sup> seems to have obtained evidence through manometric measurements of the dissociation pressures of the reaction products of boro-halides and ammonia at various temperatures that such amides and imides may actually exist. However, none have been isolated by Joannis as definite, separate, chemical compounds and analyzed.

Joannis allowed dry ammonia gas to act on  $\text{BBr}_3$ , chilled to  $-10^\circ$ , and obtained not an ammonical compound of  $\text{BBr}_3$  (as indicated by the different experiments mentioned above), but a decomposition into the imide of boron and ammonium bromide. He claims that if the reaction is carried on at  $0^\circ$  the following equation represents the actual change:



This formula demands 27 molecules of ammonia for 2 molecules of  $\text{BBr}_3$  (Joannis' data are 27.04 and 27.40). He also states that if one allows the temperature to rise to  $20^\circ$ ,  $\text{NH}_4\text{Br}$ , whose dissociation tension is higher than one atmosphere at this temperature, decomposes under atmospheric pressure, and there parts with 9 molecules of ammonia for one molecule of  $\text{BCl}_3$ . He obtained 8.77 and 8.93 experimentally.

In carrying out the experiments with ammonia and  $\text{BCl}_3$ , Joannis operated as follows: Into a tube (full of air)

<sup>1</sup> Joannis: Comptes rendus, 135, 1106 (1902).

there was introduced a known weight of  $\text{BCl}_3$ , contained in a small vial, which was opened by heating, and to this outer tube was putted a lead tube leading to a chamber containing dry, liquefied ammonia. The ammonia vaporized and gradually penetrated to the  $\text{BCl}_3$ , maintained at a little below  $0^\circ$ . The presence of the air helped to moderate the action of the ammonia. The statement is made that under these conditions the imide of boron  $\text{B}_2(\text{NH})_3$  is obtained; however, if the temperature is lowered to  $-78^\circ$  the amide of boron  $\text{B}(\text{NH}_2)_3$  is obtained, which decomposes slowly when the temperature is elevated.

The volatility of  $\text{BBr}_3$ , which is notably less than that of the chloride, did not permit of exactly the same sort of procedure, nor use of so low a temperature as to yield the amide. The imide of boron decomposes in its turn with the disengagement of ammonia.

Borimide may also be prepared by heating the additive compound  $\text{B}_2\text{S}_3 \cdot 6\text{NH}_3$ ,<sup>1</sup> to  $115-120^\circ$  in a stream of ammonia, when it decomposes, giving borimide and sulphur, the latter being removed by continued heating in ammonia. It is a white powder which is decomposed by water with evolution of heat, yielding ammonium borate. On heating, boron nitride and ammonia are formed. When shaken with liquid  $\text{HCl}$ , it forms a white hydrochloride  $\text{B}_2(\text{NH})_3 \cdot 3\text{HCl}$ .

*Boro-Nitrogen Organic Compounds. (Action of  $\text{BBr}_3$  on Amines and Nitriles).*—The interesting boro-halide-ammonia compounds described in the preceding paragraphs very naturally suggest the possibility of preparing a whole series of organo-boron compounds by the reaction of a boro-halide with an organic-radicle derivative of ammonia, *i. e.*, in general with the chain and cyclic amines. However, a search of the literature reveals the fact that, while several compounds have been made by using halides of silicon, arsenic and phosphorus, almost none at all have been prepared with the halides of boron. I consequently decided to attempt the

<sup>1</sup> Basarow: Comptes rendus, 78, 1698, 4698 (1874).

preparation of a series of new amino-boron compounds of the most typical and characteristic classes.

As  $\text{BBr}_3$  is more readily prepared and preserved than  $\text{BI}_3$  and more easily handled at room temperature than  $\text{BCl}_3$ , it was chosen in this work. Furthermore, one would naturally expect the compounds formed with  $\text{BBr}_3$  to present about average properties for the halide compounds in general on account of the position of bromine with respect to chlorine and iodine in the periodic system.

The typical amines selected include examples of primary, secondary and tertiary amines from both the aliphatic and the aromatic series, as well as some mixed and heterocyclic compounds of the pyridine class. For the sake of brevity and system in the discussion of the results the particular examples are classified in tabular form as shown in table following. In the first column are placed examples of primary aliphatic and aromatic amines, in the order of their complexity. The next column contains examples of secondary amines, the third tertiary amines and the fourth nitriles.

TABLE OF REPRESENTATIVE AMINES AND NITRILES

Primary	Secondary	Tertiary	Nitriles
$(\text{CH}_3)\text{NH}_2$ $(\text{C}_2\text{H}_5)\text{NH}_2$	$(\text{CH}_3)_2\text{NH}$	$(\text{CH}_3)_3\text{N}$ $(\text{C}_2\text{H}_5)_3\text{N}$	$(\text{CH}_3)\text{CN}$ $(\text{C}_2\text{H}_5)\text{CN}$
$i\text{-(C}_5\text{H}_{11})\text{NH}_2$	$(\text{C}_3\text{H}_7)_2\text{NH}$ $i\text{-(C}_5\text{H}_{11})_2\text{NH}$ $\text{C}_5\text{H}_{10}\text{NH}$ (Piperidine)	$\text{C}_5\text{H}_5\text{N}$ (Pyridine)	
$(\text{Ph})\text{NH}_2$	$(\text{Ph})_2\text{NH}$	$\text{C}_9\text{H}_7\text{N}$ (Quinoline) $(\text{Ph})(\text{CH}_3)_2\text{N}$	$(\text{Ph})\text{CN}$ $\text{Ph.CH}_2\text{.CN}$

#### General Method of Procedure

Boron-tribromide, the reagent common to all the subsequently described reactions, was usually prepared by passing bromine over pure boron contained in a Jena combustion

tube. The details of methods for preparing boron-tribromide, and also descriptions of the most important physico-chemical properties of this substance, will appear in a separate publication in the near future. The samples used were always very carefully purified and appeared as colorless as water. They boiled at a constant temperature, usually about  $91^{\circ}$ .

In all cases the amines not gases at room temperature, were distilled from lime or sodium hydroxide immediately before using, the fraction from  $3^{\circ}$  below to  $3^{\circ}$  above the boiling point as given in chemical hand-books being taken whenever the boiling point was not constant. In all experiments it was always made certain that the amine was perfectly dry, the compound being allowed to stand over calcium chloride or lime for some time before using.

The liquid reagents were placed in graduated burettes protected with drying tubes at the top. Extensive preliminary work had shown that most of the compounds were almost insoluble in  $\text{CCl}_4$  and  $\text{CS}_2$ . Of these two  $\text{CCl}_4$  was usually the better medium, as the  $\text{CS}_2$  in some cases gave slightly jelly-like masses, when used as a reaction medium. An Erlenmeyer flask of 250 cc capacity was provided with a two-hole stopper. Into one of these holes was inserted a small drying tube filled with  $\text{CaCl}_2$  and into the other the delivery point of the burette. The reaction flask was partly submerged in ice water during the reaction whenever the heat evolution was great.

It was usually found most satisfactory to first dissolve the  $\text{BBr}_3$  in about two to four times its own volume of  $\text{CCl}_4$ , then allow the amine, likewise dissolved in  $\text{CCl}_4$ , to drop into the former solution. However, in several instances pure  $\text{BBr}_3$  was added drop by drop to the solution of the amine in  $\text{CCl}_4$  until the reaction ceased. (Of course where the amine was a solid it had to be first dissolved in  $\text{CCl}_4$ .) The products in the different cases were compared with one another.

With the lower members of the series of aliphatic amines, of which about 30 percent alcoholic solutions were at hand, the solution of the amine was placed in a flask containing

NaOH and attached to a reflex condenser. A return tube led from the upper end of the condenser down into the reaction flask, which was usually a small distilling flask containing a solution of  $\text{BBr}_3$  in  $\text{CCl}_4$ . The side tube of the distilling flask was provided with a Bunsen valve. On gently heating the flask containing the amine the latter was driven up the condenser as a gas and finally bubbled into  $\text{BBr}_3$  solution where chemical action occurred.

*Treatment of the Precipitates.*—Usually the precipitates initially formed were readily decomposed by moisture, and also dissociated at temperatures but little above room temperature; hence the necessity of an arrangement for handling the precipitate in such a manner as to eliminate both of these sources of disturbance if necessary. The apparatus depicted in Fig. 1 served the purpose admirably. After a reaction

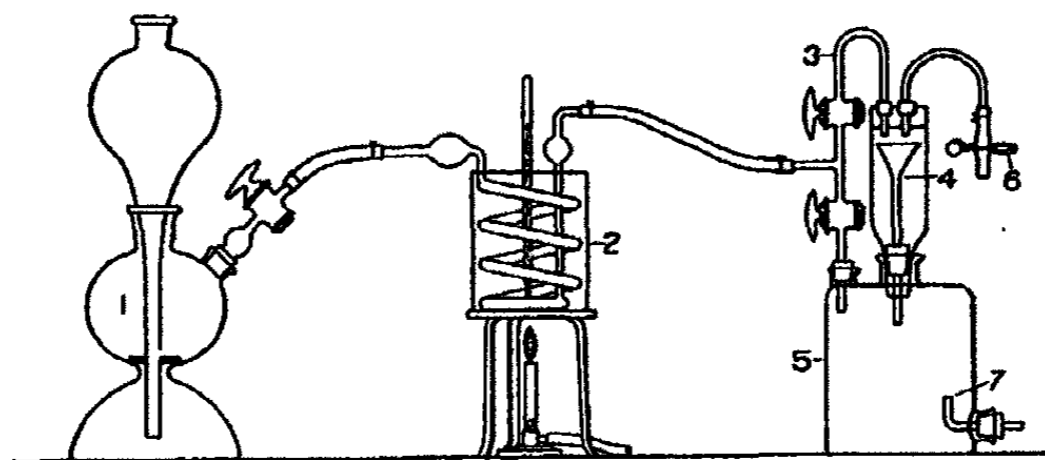

Apparatus for Filtering, Washing and Drying Boron Compounds

Fig. 1

was completed in the  $\text{CCl}_4$  or  $\text{CS}_2$ , the precipitate was allowed to settle, the medium poured off and replaced with a fresh lot. After shaking and allowing to settle, the decantation was repeated several times. The precipitate was then placed in the funnel (4) provided with common filter paper and filtered rapidly by suction (when needed) applied at (7), dry hydrogen, or air being supplied to the apparatus after passing through a sulphuric acid dryer (2) which could be maintained at any common temperature. When sufficiently washed with  $\text{CCl}_4$  or  $\text{CS}_2$ , or both, taken in at (6), the current

of gas was drawn through the material until quite dry. It was then transferred to small containers and kept in a desiccator.

*Method of Analysis.*—In all the following work it was deemed sufficient to determine quantitatively the nitrogen and halogen only. Boron is exceedingly difficult to determine directly with consistent results when working with different kinds of compounds, hence its presence in the substances was ascertained qualitatively only. The halogen was determined gravimetrically as AgBr, and the nitrogen was determined by the Kjeldahl method,  $P_2O_5$  and  $H_2SO_4$  being used for digestion.

#### Action of $BBr_3$ on Primary Amines

*Methyl Amine and  $BBr_3$ .*—The methyl amine obtained from a 30 percent alcoholic solution, prepared by Merck, was heated under a reflux condenser as described above and the gas passed directly into a  $CCl_4$  solution of  $BBr_3$  until no further precipitate was formed. Even on the slow introduction of the gas into the solution there was a very decided rise of temperature. The snow-white precipitate is practically insoluble in  $CCl_4$ . After being thoroughly washed and dried, there remains a very fine powder which is crispy under the spatula, but appears on examination under the microscope to be practically devoid of a definite crystalline form. When the substance is introduced into water there occurs a violent reaction, and complete solution of all of the products. In the air of the laboratory the material gradually dissociates, fumes of  $B(OH)_3$  and HBr escaping. An analysis of the powder gave the following results:

	N	Br
Calculated	18.55	53.00
Found	18.47	53.20
Formula	$(CH_3)_2 : (NH)_2 : BBr$	

*Ethyl Amine and  $BBr_3$ .*—This next higher member of the series was prepared in exactly the same manner as described



above. However, the product obtained, in spite of much washing with  $\text{CCl}_4$ , was not quite so pure white. This product, like its next lower homologue, was quite amorphous. The following figures obtained from an analysis:

	N	Br
Calculated	6.52	74.45
Found	6.61	73.91
Formula	$\text{C}_7\text{H}_5\text{.NH.BBr}_2$	

*Mono-Iso-Amyl-Amine and  $\text{BBr}_2$ .*—A little over 5 grams of the dry amine, boiling between  $95^\circ$  and  $98^\circ$ , was dissolved in dry  $\text{CCl}_4$ . Approximately a molecular equivalent amount of  $\text{BBr}_2$  was likewise dissolved in  $\text{CCl}_4$ , and then run drop by drop into the amine solution, cooled by ice water on the outside and always shaken after each addition. Though the reaction was apparently not violent, still, much heat was evolved. At first, considerable of the precipitate appears to partially dissolve in the  $\text{CCl}_4$ , warmed up by the heat of the reaction, giving a yellow, oily solution rising to the upper portion of the  $\text{CCl}_4$  medium, and growing more of an orange color until  $\frac{1}{2}$  mol of  $\text{BBr}_2$  has been added; but from this point on, there forms a white, voluminous precipitate until one mol of amine has been added.

Examined under the compound microscope, the precipitate appears perfectly amorphous and exceedingly fine-grained, in fact, the grains were not as large as butter-fat globules with which they were directly compared. After several decantations and washings and then drying in the apparatus already described, the material may be handled with considerable impunity on a porcelain plate in the laboratory. It rubs down perfectly smooth under the spatula, does not dissociate very rapidly below  $40^\circ$ , turns light yellow in sunlight, and reacts with water, especially when alkaline with  $\text{NaOH}$ , with considerable energy. If warmed up rapidly on a piece of platinum it appears to melt and decompose at once. It will ignite and burn furiously, coloring the flame intensely deep green.

ANALYSIS		
	N	Br
Calculated	4.14	70.81
Found	4.16	70.73
Formula	$(C_6H_{11})_2NH_2 \cdot BBr_3$	

The composition of the oily product first formed is probably  $[(C_6H_{11})_2NH_2]_2BBr$ , though, thus far no attempts have been made to purify and analyze the product.

*Mono-Phenyl-Amine (Aniline) and  $BBr_3$ .*—The mode of procedure for the preparation of a compound of these two substances was in all details the same as for the amyl-amine compound. The best grade of aniline was used and twice distilled immediately before use, an almost perfectly colorless liquid being obtained. No matter whether the aniline is added drop by drop to the  $BBr_3$  solution, or the  $BBr_3$  to the aniline, if the reaction is too fast, a deep yellow precipitate results at first. But if the addition is slow and the vessel well cooled, there is obtained a perfectly white, amorphous precipitate. After being washed and dried and taken into air it fumes strongly, and moisture rapidly converts it into boric acid and aniline hydrobromide. In alkaline solution aniline oil appears. An analysis of the product obtained (quickly dried and prevented as much as possible from decomposing) gave the following results:

	N	Br
Calculated	4.07	69.80
Found	4.03	69.92
Formula	$(C_6H_5)_2NH_2 \cdot BBr_3$	

#### Conclusions Regarding the Nature of the Reaction of a Primary Amine with $BBr_3$

Fairly general conclusions may be drawn from a survey of the formulae of the above described compounds as to the formula of the compound that may be expected when any primary amine reacts with  $BBr_3$ . It will be noted that in the case of the lower members of the series, the  $BBr_3$  reacts with more than one molecule of amine, but also splits off hydro-

bromic acid very readily to form a compound which is not so rich in halogen and more stable. Higher homologues have a greater tendency to combine with the  $\text{BBr}_3$  molecule for molecule, and less tendency to part with halogen. Compounds with five or more carbon atoms appear to form addition products which are quite stable at room temperature and pressure if moisture is absent. We may represent the foregoing facts very well by the following series of formulae:

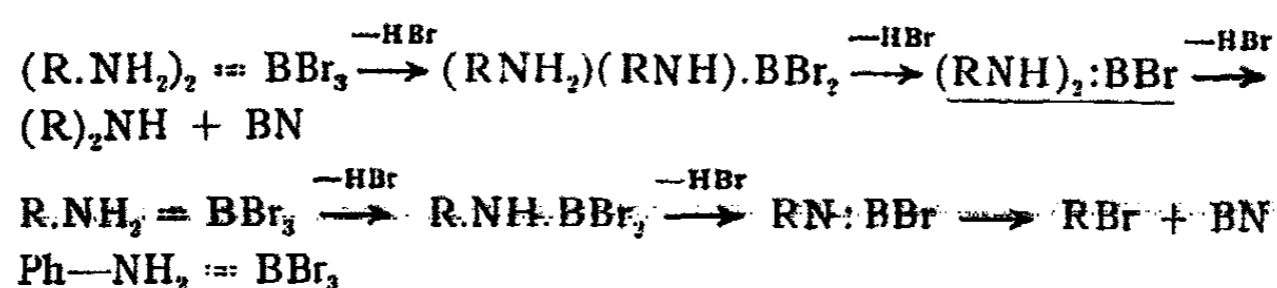

R = Alkyl group.  
Ph = Phenyl group.

From these formulae and series it is evident how a great number of products are possible. The possibility of the formation of any particular type depends on the place of the amine in the homologous series and the conditions of the experiment. The formulae underscored represent types which have actually been formed. The writer hopes to be able to follow out by experiment these series of possible products to the final halogenless decomposition products.

#### Action of $\text{BBr}_3$ on Secondary Amines.

*Di-Methyl-Amine and  $\text{BBr}_3$ .*—As this substance is a gas under ordinary laboratory conditions, its alcoholic solution had to be used and the amine distilled off by heat as in the case of mono-methyl-amine already described. Here too, the precipitate formed from the reaction of di-methyl-amine and  $\text{BBr}_3$  appears so much like that from mono-ethyl-amine that the same description will answer for both. The former is slightly more stable in presence of moisture, and its dissociation does not appear to be so great under common conditions. The white, dry material readily reacts with water, alcohol and ether.

ANALYSIS		
	N	Br
Calculated	6.52	74.25
Found	6.57	74.31
Formula	$(\text{CH}_3)_2 = \text{N} - \text{BBr}_2$	

*Di-Propyl-Amine and BBr<sub>3</sub>.*—A quantity of di-propyl-amine, boiling between 108° and 111° was dissolved in CCl<sub>4</sub>. Into this solution was dropped a solution of BBr<sub>3</sub> in the same solvent. The first half of the BBr<sub>3</sub> added (about 1/2 mol) formed an oily, light layer above the main portion of the CCl<sub>4</sub> solution, in which it seemed but slightly soluble. Further addition, however, brought down a white precipitate and when a trifle more than one molecule was added, there was only a suspension of a fine white precipitate in the reaction medium, the latter being discolored but slightly. This precipitate, when washed and dried, like the previous ones, proved to be a soft, pure white powder of no definite crystalline form. Much heat is evolved during the formation of the compound and the reaction flask must be well cooled. The product isolated is only fairly stable at ordinary temperature if kept from moisture.

ANALYSIS		
	N	Br
Found	5.19	59.18
Calculated	5.108	59.22
Formula	$(\text{C}_3\text{H}_7)_2 : \text{N} \cdot \text{BBr}_2$	

*Di-Amyl-Amine and BBr<sub>3</sub>.*—Not unlike the action of BBr<sub>3</sub> on dipropyl-amine is its action on di-iso-amyl-amine, only here the oily layer which is first formed appears to become almost gelatinous on continued addition of the BBr<sub>3</sub>. But when a whole molecular equivalent quantity has been added with constant shaking, there forms a creamy to granular precipitate which is exceedingly hard to filter off and wash. Much better results are obtained when the precipitate is allowed to stand in the reaction medium two or three days after the reaction before attempting to separate it. The product dissolves to some extent in CCl<sub>4</sub> and may be slowly

crystallized from the same. The pure white substance reacts with water, yielding di-iso-amyl-amine-hydrobromide and boric acid. At ordinary room temperature it readily yields a hydrobromic acid and boric acid fumes.

ANALYSIS		
	N	Br
Calculated	4.28	48.81
Found	4.16	48.65
Formula	$(C_5H_{11})_2 \cdot N : BBr_2$	

*Piperidine and BBr<sub>3</sub>*.—In connection with the investigation of the action of BBr<sub>3</sub> on the secondary amines, piperidine seems of especial interest. We must regard this compound as a type of secondary amine, for it has the group: N.H, only here the two nitrogen bonds are satisfied by carbon bonds of the same nucleus, thus forming a closed figure instead of an open one as is the case in the ordinary secondary amine.

The samples of piperidine used for different trials were all taken from an ounce bottle of material by Merck. The substance boiled sharply at 105.5°. After drying and redistilling the piperidine, as in all preceding work, it was dissolved in CCl<sub>4</sub>, which was also perfectly dry and pure. In some trials the piperidine was added to a slight excess of BBr<sub>3</sub> and in others BBr<sub>3</sub> was added to an excess of piperidine, but in either case the same final product was obtained. The reaction takes place with great violence, much greater than with ordinary secondary amines and there is a great disengagement of heat, necessitating careful cooling of the reaction system, even when the materials are brought together very slowly, in order to ensure a good product. Such precautions give a very light yellow precipitate, which can be washed thoroughly with CCl<sub>4</sub> and dried in a current of dry air or hydrogen. Under ordinary conditions the product gives off abundant fumes of HBr, rapidly undergoing transformation into a stable product which dissolves readily in several organic solvents, apparently without decomposition, yielding greenish yellow solutions of fluorescing properties.

This latter substance is best obtained from the initial precipitate by spreading it out in a thin layer in a desiccator containing fused calcium chloride and solid sodium hydroxide. Analysis of the initial product gave the following figures:

	N	Br
Calculated	8.31	47.34
Found	8.37	47.21
Formula	$3(\text{C}_5\text{H}_{10}\text{NH}) = \text{BBr}_3$	

Analysis of second product obtained by splitting off HBr:

	N	Br
Calculated	9.88	37.49
Found	9.83	37.54
Formula	$\text{C}_5\text{H}_{10}\text{N} \cdot \text{BBr}_2 : (\text{C}_5\text{H}_{10}\text{NH})_2$	

*Di-Phenyl-Amine and BBr<sub>3</sub>*.—Seven grams of di-phenyl-amine prepared by Merck, melting at 52.0° and boiling at 311° were dissolved in CCl<sub>4</sub> and to the solution was added a solution of BBr<sub>3</sub>. A voluminous, snow-white precipitate forms instantly with only moderate evolution of heat. As compared with the other compounds of the secondary amines this product is much more stable under ordinary room conditions. An analysis of the substance gave the following results:

	N	Br
Calculated	5.54	31.60
Found	5.59	31.57
Formula	$((\text{Ph})_2\text{NH})_3 : \text{BBr}_3$	

*General Type of Reaction between Secondary Amine and BBr<sub>3</sub>*.—A review of the meager number of compounds of the three different types of secondary amines at hand would appear to indicate that the aliphatic amine compounds are generally the simplest—molecule of amine for molecule of brom-boride—and that the lone hydrogen atom quickly drops off with a halogen atom, leaving a compound which is more stable under ordinary conditions. If the series were followed to its termination BN would probably be the final product.

Not so simple, however, is the case of piperidine and other cyclic aromatic amines. Here as high as three molecules of amine will unite with one molecule of  $\text{BBr}_3$ , and still the new substance will not split off  $\text{HBr}$  so readily that they cannot be handled in dry air at ordinary temperature and pressure, though they decompose readily on slight rise of temperature. We see in this case that the gradual splitting off of  $\text{HBr}$  would not be so likely to yield  $\text{BN}$ .

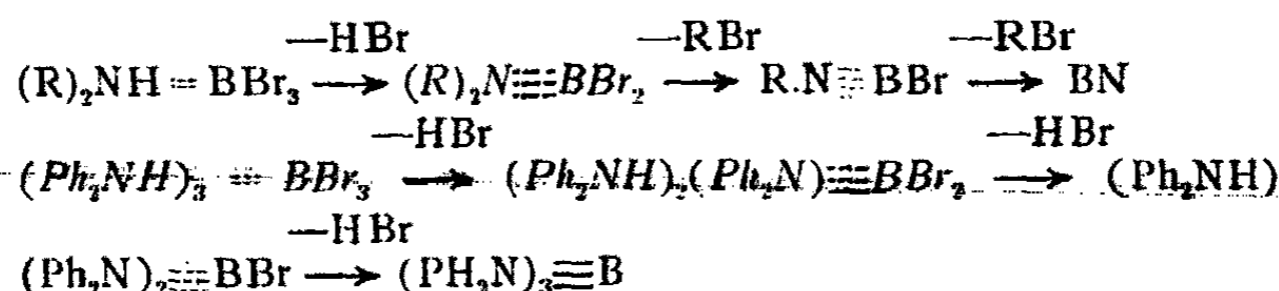

#### Action of $\text{BBr}_3$ on Tertiary Amines

*Trimethyl Amine and  $\text{BBr}_3$ .*—The trimethyl amine was driven from an alcoholic solution in the manner already described and passed into a small flask containing  $\text{BBr}_3$  and  $\text{CCl}_4$ . When the gaseous amine reached the flask, action took place immediately with evolution of heat, but only a slight precipitate formed and copious white fumes were evolved from the liquid. It was quite apparent that a general decomposition was going on and perhaps a dissolution of the initial product. No success was met with in attempting to crystallize out a definite compound; the amount of precipitate formed was small, and qualitative tests showed that it contained no halogen.

*Tri-Ethyl-Amine and  $\text{BBr}_3$ .*—A considerable quantity of tri-ethyl-amine which boiled at  $87\text{--}90^\circ$  was on hand. It was therefore determined, in view of the above results obtained with tri-methyl amine, to investigate its action with  $\text{BBr}_3$ . A  $\text{CCl}_4$  solution of  $\text{BBr}_3$  was prepared, and into this while well cooled there was slowly dropped a dilute solution of the amine in  $\text{CCl}_4$ . Heat was evolved, and at first a white precipitate formed which soon disappeared because of its solubility in warm  $\text{CCl}_4$ . On cooling the solution, fine crystals were deposited. These formed during the rapid cooling of

the liquid. Under the microscope they appeared as long, slender prisms, readily forming large, irregular, translucent masses. When, however, a  $\text{CCl}_4$  solution was allowed to stand for a long time, bunches of "cotton-batting-like" crystals formed and floated about in the liquid. Examination of these crystals under a microscope showed them to be exceedingly thin, long needles; in fact, many were observed whose length was at least 200 times the diameter. After washing and drying, this substance was found to be relatively unstable, especially at temperatures from  $50^\circ$  up. It is readily, though not violently decomposed by water.

ANALYSIS

	N	Br
Calculated	3.98	68.20
Found	3.47	67.88
Formula	$(\text{C}_7\text{H}_6)_3\text{N} \cdot \text{BBr}_3$	

*Di-Methyl-Aniline and  $\text{BBr}_3$ .*—One of the most important, and most interesting of the tertiary amines is di-methyl-amine. This substance also reacts readily with the boride of bromine, with considerable evolution of heat, forming masses of small, translucent crystals which are somewhat soluble in  $\text{CCl}_4$ . The masses of partially crystalline material appear under the microscope much like camphor gum. It is difficult to handle the substance in the air, for as soon as the  $\text{CCl}_4$  evaporates off, the residue becomes hygroscopic and decomposes; hence, in drying the precipitate, the air must first be passed through concentrated  $\text{H}_2\text{SO}_4$ . In cold water, the decomposition of this unstable compound proceeds rapidly though not violently, as one might expect, forming an oil, and a white, insoluble material, and also a small quantity of gas. An analysis of the camphor-like substance gave the following results:

	N	Br
Calculated	3.76	64.44
Found	3.80	63.78
Formula	$(\text{CH}_3)_2\text{NBBR}_3 \cdot \text{C}_6\text{H}_6$	



Some of the above camphor-like substance was placed with fused NaOH and CaCl<sub>2</sub> in a desiccator and kept in the vicinity of a common steam radiator until no more gases came off. The product was then washed with CCl<sub>4</sub>, dried and analyzed. The sample for analysis was introduced into hot alkali solution where it was quickly decomposed with the formation of a white, insoluble powder. The latter was filtered off in a Gooch crucible and weighed. It showed every property of BN. The halogen content of a sample and also the nitrogen were determined as usual.

	ANALYSIS		
	N	Br	BN <sup>1</sup>
Calculated	5.04	57.50	9.03
Found	4.96	57.13	8.89
Formula	(CH <sub>3</sub> ) — N =	(C <sub>6</sub> H <sub>5</sub> ) —	(BBr <sub>2</sub> )

#### Pyridine and Quinoline

The strongly basic organic compounds of the heterocyclic nitrogen-carbon type, of which pyridine is regarded as the prime representative may be regarded as tertiary amines, or ammonia derivatives, all of whose hydrogen atoms have been replaced, the nitrogen bonds being satisfied by the three different carbon atoms. However, though each carbon atom, satisfying nitrogen in the ordinary tertiary amines, is in a separate nucleus or radicle, in pyridine, on the other hand, all three carbon atoms are in the same complex (assuming the centric formula for pyridine).

*Pyridine and BBr<sub>3</sub>.*—Boron tribromide and pyridine dissolved in CCl<sub>4</sub> combine with great energy and evolution of heat. The precipitate is snow-white, light and perfectly amorphous. After driving off the CCl<sub>4</sub>, it may be worked under the spatula in the open air for some time before decomposing appreciably, but the dissociation tension increases very rapidly as the temperature rises. At 120° the compound turns brown and crispy. Analysis of the material gave the following figures:

<sup>1</sup>This is probably the first time boron has been determined directly gravimetrically in the form of BN.

	N	Br
Calculated	4.25	72.64
Found	4.29	71.96
Formula	$(C_5H_5N) = BBr_3$	

If, however, this compound is allowed to remain in a desiccator containing solid NaOH and CaCl<sub>2</sub>, a powder more stable under ordinary conditions is obtained, which after being washed with CCl<sub>4</sub>, yields the following results upon analysis:

	N	Br
Calculated	5.62	64.20
Found	5.57	64.75
Formula	$(C_6H_4)N \cdot BBr_2$	

*Quinoline and BBr<sub>3</sub>*.—As with pyridine so with quinoline and BBr<sub>3</sub>, reaction occurs readily, though apparently there is not quite so much heat evolved. Nevertheless, the analogous product is much more stable under laboratory conditions of temperature and pressure; in fact it may be handled with impunity, and worked on a porcelain plate with a spatula, without fuming to any extent. It also decomposes relatively slowly in cold alkaline solution. This pure white initial product, according to analysis, has the formula (C<sub>9</sub>H<sub>7</sub>N) : BBr<sub>3</sub>.

	N	Br
Calculated	3.69	63.03
Found	3.71	63.20

#### Correlation of Tertiary Amine-Brom-Boride Compounds

Facts thus far accumulated from work with the four kinds of tertiary amines would appear to show that there is usually first formed a simple addition-product. In the case of quinoline this compound is very permanent under ordinary working conditions, thus pointing to the general conclusion that the larger the aromatic nucleus the more stable these addition products are. Alkyl, or mixed alkyl-phenyl-amine addition compounds are much less stable and have a great

tendency to split off alkyl halide progressively to substances more permanent—even going as far as  $B \equiv N$ .

Pyridine offers an interesting fact in that its addition compound, initially formed with  $BBr_3$ , very readily splits off  $HBr$ . The hydrogen in this case must be detached from a carbon atom, thus making it evident that the boron atom becomes attached directly to carbon as well as the nitrogen.

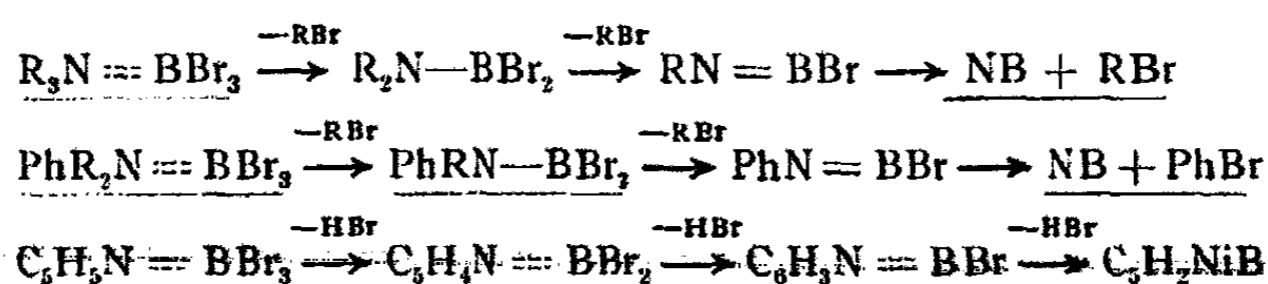

#### Action of $BBr_3$ on Nitriles

Nitriles, or organic compounds which may be regarded as esters of hydrocyanic acid of the structural formula  $HC \equiv N$ , are known to act basic in the presence of various acids, including  $HCl$  and even  $H_2S$ , forming salts of the formulae  $R.CN.HCl$  and  $R.CN.H_2S$ <sup>1</sup> respectively. We see here manifested a weak basic property, and perhaps the occurrence of the pentavalence of the nitrogen atom. Indeed a not exceedingly farfetched view is to regard a nitrile as ammonia all of whose hydrogen atoms have been displaced, the nitrogen bonds being satisfied by one and the same carbon atom instead of by three distinct carbon atoms as in the case of the tertiary amines and pyridine bases. On this basis we should expect to find in the nitrile some of the properties characteristic of amines in general.

*Hydrocyanic Acid and  $BCl_3$ .*—A review of the literature reveals the fact that Martius<sup>2</sup> attempted to bring about a reaction of  $HCN$  and  $BCl_3$  by passing the former as a dry gas into well cooled liquid  $BCl_3$ . He states that at first a solid substance forms, but that at room temperature this soon decomposes yielding a brown liquid. No analysis is given but it is assumed that the solid first formed was  $HCN.BCl_3$ .

<sup>1</sup> Comptes rendus, 63, 923 (1866).

<sup>2</sup> Liebig's Ann., 109, 80 (1859).

*Chloro-Cyanogen and BCl<sub>3</sub>.*—Martius met with much more success in conducting chloro-cyanogen in well cooled liquid boron-trichloride. The chloro-cyanogen gas is absorbed readily, with great development of heat and the formation of a white, crystalline precipitate, consisting of small prisms. The substance smells of chloro-cyanogen gas, and fumes somewhat in damp air. In water it is decomposed instantly, forming chloro-cyanogen gas, boric acid and hydrochloric acid. Similar action occurs in absolute alcohol. At higher temperature it sublimes with partial decomposition, leaving behind a white substance.

0.5736 gram of the substance, analyzed for halogen in the chlorocyanogen gas gave 1.8505 gram AgCl, representing 79.7 percent chlorine.

0.685 gram of substance analyzed for the halogen bound to the boron gave 1.7032 AgCl, representing 61.3 percent chlorine.

The formula of the compound is then BCl<sub>3</sub>.ClCN.

Gautier<sup>1</sup> claims to have formed a compound of ethylcyanide and BCl<sub>3</sub>, but, as no details are given and no analytical results, I determined to prepare, if possible, several typical alkyl and aromatic cyanide compounds with BBr<sub>3</sub> as a part of the scheme already outlined.

*Methyl-Cyanide and BBr<sub>3</sub>.*—A quantity of methyl-cyanide was redistilled several times after being dried. The fraction taken which came over between 80° and 82°, as with amines so in this case a known quantity was dissolved in CCl<sub>4</sub>, and an excess of BBr<sub>3</sub> in the same solvent was added gradually while the reaction vessel was cooled. A beautiful, flaky, snow-white precipitate separated. The substance is slightly soluble in CCl<sub>4</sub> and may be crystallized slowly from the same. At low temperature the dry powder is quite stable, but at 30° the dissociation proceeds rapidly. In water it is quickly decomposed. Upon analysis this compound gave the following results:

<sup>1</sup> Comptes rendus, 63, 923 (1866).

	N	Br
Calculated	4.81	82.00
Found	4.86	81.72
Formula	CH <sub>3</sub> CN : BBr <sub>3</sub>	

*Ethyl-Cyanide and BBr<sub>3</sub>*.—The compound formed between these two substances is in every way similar to the preceding, except that it is less slowly acted upon by moisture, and does not dissociate at so low a temperature. Much heat is developed during the reaction.

ANALYSIS		
	N	Br
Calculated	4.58	78.21
Found	4.57	78.23
Formula	(C <sub>2</sub> H <sub>5</sub> )CN : BBr <sub>3</sub>	

*Phenyl-Cyanide and BBr<sub>3</sub>*.—The phenyl-cyanide used was a sample prepared in my laboratory. It boiled sharply at 189°. When treated with BBr<sub>3</sub> it yielded a substance which was quite soluble in CCl<sub>4</sub>, but good. Crystals were obtained with some difficulty. The compound is pure white powder when dry, attracts moisture readily, and decomposes quickly in H<sub>2</sub>O.

ANALYSIS		
	N	Br
Calculated	3.96	67.62
Found	3.87	67.57
Formula	(C <sub>6</sub> H <sub>5</sub> )CN : BBr <sub>3</sub>	

*Benzyl-Cyanide and BBr<sub>3</sub>*.—This homologue of phenyl-cyanide is of interest in connection with compounds of nitriles with boro-halides, as a methylene group stands between the (C<sub>6</sub>H<sub>5</sub>) and (CN), and thus we might expect the substance to have properties lying between those of the methyl cyanide and phenyl cyanide. Like with the phenyl compound the reaction proceeds with the development of comparatively little heat. A sample of the product taken directly from the reaction medium and examined under the microscope showed an almost amorphous, translucent mass, although around the edges of the field there were found a few clusters of small

needles. Later it was observed that the dried material would absorb considerable  $\text{CCl}_4$ , and dissolve to some extent in it; but it was difficult to get well formed crystals from the solution. Carbon bisulphide was even a worse solvent in some respects. When purified as far as feasible by the use of both  $\text{CS}_2$  and  $\text{CCl}_4$ , the final product still had a faint, yellow color, which is probably characteristic. It fumes in the air and may be melted down, but not without some decomposition.

ANALYSIS		
	N	Br
Calculated	3.81	65.00
Found	3.73	64.81
Formula	$(\text{C}_6\text{H}_5\text{CH}_2)\text{CN} : \text{BBr}_3$	

#### General Type of Reaction between a Nitrile and $\text{BBr}_3$

Nitriles, like tertiary amines, form simple addition products with boro-halides. But the addition products with the nitriles do not split off  $\text{HBr}$  nor yield  $\text{BN}$  as readily under the same experimental conditions as the addition products with amines. Carbon and nitrogen are known to form a powerful union. Boron and nitrogen also form an exceedingly stable compound. In these compounds there probably is a combination of these three elements in which they are held together by mutual powerful affinities and which makes for the stability of the molecule as a whole. However, at fairly high temperatures, it is likely that  $\text{BN}$  would be formed, especially in view of the general method of forming  $\text{BN}$  as given in the opening paragraphs of this work.

The following formulae indicate the typical reactions between nitriles and boron bromide:

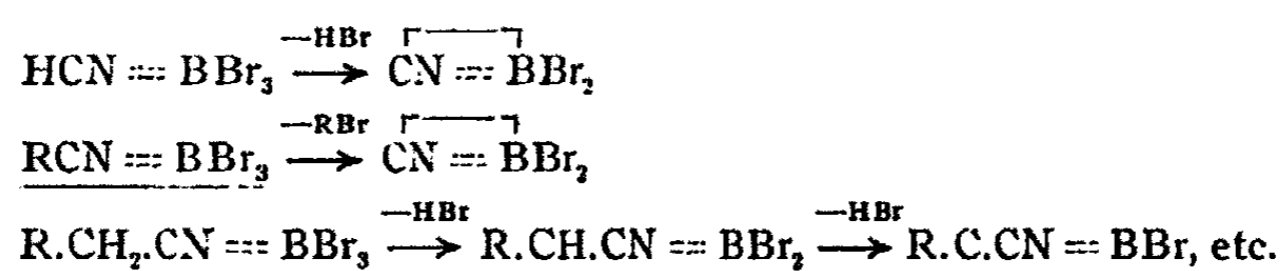

In addition to the general conclusions already stated, it may be added that in carrying on the preceding work the

great mutual attraction of boron and nitrogen, and the fact that either element may function as a trivalent or penta-valent element, have been kept steadily in mind as fundamental and guiding facts. And all the compounds of nitrogen used in this work may be regarded as derivatives of ammonia.

As might be expected, most of these new organic boro-nitrogen compounds decompose instead of melting when heated in a melting point tube. Sublimates also form in several instances. In fact, they closely resemble ammonium compounds in many ways. As a rule the compounds of the nitriles with  $BBr_3$  are far more stable toward heat than those of the amines with  $BBr_3$ . Some of these may be heated to nearly  $200^\circ$  before decomposing. Of the amine products those of pyridine and quinoline are the most stable.

The various graphic formulae given were determined, not alone from valence considerations and the results of the analyses of the compounds, but also from the action of the compounds toward weakly alkaline solutions and various reagents. In the case of many of the products initially formed (least stable) the relative proportions of  $BBr_3$  and the amine were roughly determined from readings of the burette from which a solution of one of the reagents was dropped into a solution containing a known amount of the other until a precipitate no longer formed.

The actions of a number of the more stable compounds prepared upon about twenty common organic solvents were noted. For the sake of brevity in discussing the results these solvents may be classified as: those containing oxygen; hydrocarbons; and halogen derivatives of hydrocarbons. As representatives of the first group were selected absolute alcohol, amyl alcohol, acetaldehyde (para), acetone, acetic ester, amyl acetate, ether, glacial acetic acid, nitrobenzene. Representatives of the second group were petroleum ether, benzol, toluol, xylol. In the third class, chloroform, carbon tetrachloride, bromoform, ethyl bromide and phenyl bromide. Each of the boro-nitrogen compounds studied showed, of course, its specific and characteristic action toward any

particular solvent, but still, certain fairly general rules may be drawn from the data at hand. Both the amine and nitrile compounds, as a rule, react violently with absolute alcohol, acetaldehyde, and acetic acid. Boric acid was formed in all cases, and alkyl bromide, bromaldehyde and acetyl bromide in alcohol, aldehyde, and acetic acid respectively. Fumes of hydrobromic acid were often evolved. The action of both amine and nitrile compounds upon acetone, the esters, and ether, was usually far less violent than in the hydroxyl solvents. Indeed, in several cases the compounds appear to merely dissolve, and after evaporating spontaneously, crystalline products appear which contain carbon and boron.

Almost without an exception both the nitrile and amine compounds were found quite insoluble in the hydrocarbons. But if the compound under test was left in contact with the hydrocarbon for several hours, it became colored red to brown, and the solution assumed a "bromine color." The action was enhanced by sunlight, and was most noticeable in benzol, then petroleum ether, then toluol and least apparent in xylol. However, the action was sufficient in all cases to discourage the use of the hydrocarbons as media for precipitations and crystallizations. . . . . The third group gave by far the most satisfactory results as solvents, or media for carrying out precipitations. In no case could it be said that the boro-nitrogen compound was copiously soluble in any one of the solvents, yet in a few instances crystallization could be carried out without decomposition taking place. Carbon tetrachloride and carbon tetrabromide are the most satisfactory media for precipitations, as the solubility is usually slight at room temperature and no reactions occur with these solvents. But chloroform and bromoform presented complications. At first they are apparently good solvents for several of the compounds, but after a few hours or days discoloration sets in and a gel separates. Perhaps the lone hydrogen atom in these solvents has a tendency to enter chemical reaction with the halogen of the boro-nitrogen compounds.



To Dr. L. Kahlenberg is due my most sincere thanks for the hearty encouragement which he has given me ever since the inception of my work on the chemistry of boron. He has aided me, not only by giving freely valuable suggestions, but also by supplying me with many samples of expensive amines and nitriles.

## THE PHOTOGRAPHIC PLATE VII

BY WILDER D. BANCROFT

### The Latent Image. Part III

Carey Lea was the first to consider that the latent photographic image is a phase of varying composition, a solid solution as it is usually called.

He says:<sup>1</sup>

"For more than a generation past, the nature of the latent photographic image, that which forms the basis of development, has been in dispute. Two theories have been maintained. According to the one, the first effect produced by light is simply a physical change, predisposing the elements of the silver haloid to dissociation, so that when a reducing agent is applied, the molecules so affected, yield more quickly to its influence. According to the other theory, the invisible image is formed of a sub-salt (subchloride, etc.). Observations which I published many years ago led strongly to the first-mentioned of these theories. But of late years, results have been obtained not easily reconcilable with it. On the other hand, the theory that the latent image is formed of sub-salt is opposed to striking facts. Silver subchloride for example is an unstable substance, quickly destroyed by dilute nitric acid. But I have formed a latent image on silver chloride and after exposing it for five minutes to the action of strong nitric acid (sp. gr. 1.36) have developed the image without difficulty; the same with silver bromide. Evidently these images, which so strongly resisted the action of undiluted acid could not be formed of simple subchloride and subbromide of silver, substances quickly destroyed by it.

"In the desire to find a satisfactory explanation of the nature of the image based on adequate chemical proof, I have devoted nearly three years of laboratory work to this and to closely allied subjects. I am led to the conclusion

<sup>1</sup> Am. Jour. Sci., [3] 33, 349 (1887).

that neither of the older views is correct. A truer theory seems to be deducible from the result of some experiments which I published in 1885, to the effect that the silver haloids were capable of uniting with certain other substances, much in the same way that alumina forms lakes. When a silver haloid was precipitated in the presence of certain coloring matters they combined with it, and though soluble in water, they could not be subsequently washed out. They had formed a somewhat stable compound, although the proportion of the coloring matter was very small in comparison with the haloid; evidently much too small to represent a stoichiometrical composition.

"Now I find that a silver haloid may in the same way, unite with a certain proportion of its own sub-salt, which by this union quite loses its characteristic instability and forms a compound of great permanence.

"Another explanation is possible: the sub-salt may combine with the normal salt, not in the manner above described, but in stoichiometrical proportion, and this compound may be diffused through ordinary silver haloid. I have not been able to find any reaction decisive between these explanations, but the general behavior of the substance seems rather to indicate the first named explanation as the true one. When the red chloride, for example, has been boiled with dilute nitric acid for a few moments to eliminate any uncombined subchloride, the proportion of subchloride left has never exceeded 8 or 9 percent in over thirty specimens analyzed. If we took this to represent a compound in equivalent proportions, we should have to suppose the union of at least twenty equivalents of  $\text{AgCl}$  with one of  $\text{Ag}_2\text{Cl}$ , which is improbable. If we suppose that these colored substances containing from less than 0.5 percent up to 8 or 9 percent of  $\text{Ag}_2\text{Cl}$  consist of a compound of one equivalent of subchloride united to a small number of equivalents of normal chloride, mixed mechanically with a large quantity of normal chloride, then it would be improbable that specimens could not be obtained containing a larger proportion of this compound

and consequently of  $\text{Ag}_2\text{Cl}$ , but as already said, specimens containing more than 9 percent after thorough treatment with nitric acid to remove the uncombined subchloride I have never obtained: generally the amount is less.

“Even when silver chloride, bromide or iodide contains as little as one-half of 1 percent of sub-salt combined, its properties are greatly changed. It has a strong coloration and its behavior to light is altered. Even a much less quantity, one inappreciable to analysis, is capable of affecting both the color and the behavior to light. It is one of these latter forms of this substance that constitutes the actual material of the latent photographic image.”

Of the three haloids, the chlorine salt is the most interesting, because of its relations to heliochromy; it is also the most stable of the three compounds and exhibits perhaps a finer variety of coloration, though the bromide and iodide are also obtainable of very beautiful tints. The chloride shows all the warm shades from white to black through the following gradations: white, pale flesh color, pale pink, rose color, copper color, red purple, dark chocolate, black.

These compounds are obtained in an endless variety of ways: by chlorizing metallic silver; by acting on normal chloride with reducing agents; by partly reducing silver oxide or silver carbonate by heat and treating with HCl; by forming suboxide or a sub-salt of silver and treating with HCl followed by nitric acid; by acting on subchloride with nitric acid or an alkaline hypochlorite, etc., by attacking almost any soluble salt of silver with ferrous, manganous or chromous oxide, etc., followed by HCl; by reducing silver citrate by hydrogen and treating it with HCl; by treating a soluble silver salt or almost any silver solution with potash or soda and almost any reducing agent, cane sugar, milk sugar, glucose, dextrine, aldehyde, alcohol, etc., and supersaturating with HCl; there is no organic easily oxidizable substance that I have tried that has failed to give this reaction. Also almost any salt of silver exposed to light, treated with HCl and then with hot strong nitric acid yields it. Almost

any of these classes represents a long range of reactions, each susceptible of endless variation. In fact, the more the matter is studied, the more extended the range of reactions is found to be that give rise to the formation of this substance. To show how slight an influence will lead to the production of red chloride instead of white; if freshly precipitated argentic oxide is mixed for a few minutes with starch or tragacanth paste and is then treated with HCl, the result is, not white, but pink silver chloride. Even raw starch flour mixed with silver oxide will in a few moments cause it to give a pale, flesh colored chloride with HCl. Boiled starch or tragacanth paste does this more quickly and acts more strongly, even in the cold, and still more if heat is applied.

"Although red is probably the most characteristic color of this substance, so that I have spoken of it as red chloride, nevertheless this seems hardly a proper name for a substance that is often purple, chocolate or black, sometimes brown or even ochreous, sometimes lavender or bluish, and is probably capable of assuming every color of the spectrum. To call it argento-argentic chloride would infer a stoichiometrical composition that, as already mentioned, seems very uncertain, too much so as to serve as the basis of the name. Therefore, and as these substances have been hitherto seen only in the impure form in which they are produced by the continued action of light on the normal salts, it might be convenient to call them photosalts, photochloride, photobromide, and photoiodide instead of red or colored chloride, etc., and thus to avoid the inexactness of applying the term red chloride to a substance exhibiting many other colors.

"Black or purple-black chloride is easily obtained by the action of an alkaline hypochlorite on finely divided silver such as obtained by reduction in the wet way. Commercial sodium hypochlorite may be used to act on it. It is to be poured over the silver and after standing a few minutes, is to be replaced with fresh. After an hour or two this is again to be replaced with a new portion, which is to be allowed to act half an hour to insure the total conversion of the silver.

The product varies somewhat in color, is sometimes black, oftener purple-black. If the treatment with hypochlorite has been thorough, strong cold nitric acid of 1.36 sp. gr. extracts from it no silver. This reaction with nitric acid is important as it shows that not only metallic silver was not present, but that the product contained absolutely no uncombined subchloride. For if any were present it would instantly be decomposed by the acid, in which one-half of its silver would dissolve. The action therefore appears to take place in this way. First subchloride is formed, part of this is further chlorized into a normal chloride which at once combines with other subchloride, thus taking it out of the further immediate action of the hypochlorite and this goes on until an equilibrium is reached and neither metallic silver nor uncombined subchloride is left, as is proved by the action of nitric acid. Alkaline hypochlorite, as will presently be shown, attacks uncombined subchloride very rapidly, they combined very slowly; by many days' contact the quantity of combined subchloride is gradually reduced.

"Prolonged treatment with hot strong nitric acid destroys all the varieties of photochloride. The time needed varies a good deal. A specimen of that obtained with hypochlorite required 25 hours' heating with acid of 1.36 in a water bath at 212° F to bring it to the condition of white normal chloride. Considering that cold dilute nitric acid instantly destroys freshly precipitated argentous chloride in the free state, this long resistance to strong acid at the temperature of boiling water must be considered most remarkable.

"When the red or photochloride is formed with the aid of a ferrous salt or ferrous oxide, I prefer to boil the product with dilute HCl to get rid of the last traces of iron, after a preliminary treatment with hot dilute nitric acid has removed silver and uncombined subchloride. The photochloride will sometimes even resist boiling aqua regia for a time.

"Protected from light, photochloride is perfectly stable.

Specimens obtained eighteen months ago appear to be quite unchanged.

"When treated with ammonia, it is far more slowly attacked than the normal. The ammonia dissolves the normal chloride only. The union between the two must therefore be broken up and this takes place slowly. The first action of the ammonia is to change the red or purple color to greenish black and then to slowly dissolve out the silver chloride. Hours are required even with a large excess of ammonia. While this is going on, if the ammonia is poured off and replaced with nitric acid, the original color reappears. If the action is continued sufficiently long, silver only remains and dissolves readily in nitric acid. A little short of this, treatment with nitric acid leaves a black residue of dark chloride mixed with metallic silver; the dark chloride being insoluble in any acid has led to some strange mistakes in a similar reaction which occurs in treating with ammonia silver chloride that has been exposed to the light. Even a theory has been had recourse to of a 'passive condition' of silver. This passive silver is simply black chloride.

"A specimen of purple-black chloride was treated with warm strong aqua regia until whitened by conversion of the subchloride to normal. By this treatment 2.563 grams of photochloride gained 9 mg, indicating the presence of  $2\frac{1}{2}$  percent of subchloride, or more exactly.

Subchloride	2.49
Normal chloride	97.51

"This is not to be taken in any sense as representing a constant composition. The proportion of subchloride varies between certain limits, not only according to the method of preparation used but independently of it. Another specimen of black chloride formed with hypochlorite gave figures that indicated a content of less than half of 1 percent of subchloride."

"It has long been known that silver was blackened by ferric chloride, and this action has been proposed in the

text-books as a means of obtaining subchloride, for which it is quite unsuited. Ferric chloride acts on silver much as sodium hypochlorite does, but less rapidly. With hypochlorite the action is complete in a few hours or often in an hour or less; with ferric chloride one or two days are required before the product ceases to yield silver to hot dilute nitric acid. In both cases the action appears to be alike in this: that no subchloride is finally left uncombined with normal chloride.

"The product is an intensely dark purple black, when the action takes place in the cold. With heat continued for many hours, ferric chloride can be made to attack the purple salt and gradually convert it into AgCl. With a strong solution in large excess kept at or near  $212^{\circ}\text{F}$  for 60 hours the color was gradually reduced to pink and finally to a dingy pinkish gray. Pure white cannot be obtained, as it can by aqua regia.

"In order to observe more exactly the course of the action, a strong solution of ferric chloride was allowed to act on reduced silver in fine powder for four minutes, and then a fresh portion (always in large excess) for the same time. Analysis showed that at this stage of the action the material contained:

Ag (determined)	76.07
Cl (by difference)	23.93
	<hr/>
	100.00

"If we suppose that all the silver was combined with chlorine, the constitution of the substance would be:

AgCl	92.49
Ag <sub>2</sub> Cl	7.51
	<hr/>
	100.00

but this was probably not the case, there was almost certainly free silver present and consequently a less proportion of subchloride. Another specimen, treated repeatedly with hot acid until every trace of free silver was removed was found



to contain 1.52 percent of subchloride, color purple. Another similarly treated contained 7.3 percent subchloride.

"When freshly precipitated and still moist subchloride of silver is treated with nitric acid, a sharp effervescence accompanied with a disengagement of red fumes, sets in; presently the strong red coloration of the photochloride appears and the action ceases. This production of the red and not the white chloride in the decomposition of  $\text{Ag}_2\text{Cl}$  is precisely what might have been expected, for when  $\text{AgCl}$  is formed in the presence of  $\text{Ag}_2\text{Cl}$  more or less combination always takes place.

"The action is interesting in this respect: the  $\text{AgCl}$  first formed is at the moment of formation in presence of all the yet undecomposed portion of the  $\text{Ag}_2\text{Cl}$ , and whatever part it combines with is removed from the action of the acid. It would therefore seem probable that this method would be one of those that yielded a product having the largest proportion of  $\text{Ag}_2\text{Cl}$ , but analysis showed that different specimens were extremely variable—of those analyzed, one contained 8.62 percent of  $\text{Ag}_2\text{Cl}$ , and another 6.56, and a third 1.96. All the analysis can do with such substances is to fix the limits within which they vary. The quantity of subchloride left after treatment with nitric acid depends partly on the strength of the acid and the time for which it is allowed to act, but also to some extent on variations in the resistance of the substance itself. These specimens were of shades between rose and purple.

"The color of any particular specimen is always lightened in shade by abstracting  $\text{Ag}_2\text{Cl}$  from it by continued boiling with nitric acid. But as between different specimens, especially when formed by different reactions, it by no means follows that the darkest in color contains the most subchloride. Argentous chloride when treated with sodium hypochlorite yields a purple form of photochloride. A specimen so treated contained 2.57 percent of  $\text{Ag}_2\text{Cl}$ ."

"Exposed to ordinary diffuse light all the bright shades

of silver photochloride quickly change to purple and purple-black. The darker shades are more slowly influenced.

"Mercuric chloride gradually changes it to a dirty white. Mercuric nitrate dissolves it easily and completely, but apparently with decomposition, as it can only be recovered as white chloride. Potassic chloride seems to be without effect. Potassic bromide soon converts it to a dull lilac, which at the end of twelve hours, showed no further change. In contact with potassic iodide the color instantly changes to blue-gray; this change is produced by a quantity of iodide too small to dissolve even a trace of silver; the filtrate is not darkened by ammonium sulphide. With a larger quantity silver is dissolved abundantly. By acting with renewed iodide solution, the substance continually darkens and diminishes until only a few black points, barely visible, are left.

"Treated with dilute solution of potassium chlorate and HCl, the red substance gradually passes to pink, to flesh color, and finally to pure white.

"The action of heat on the photochloride is very curious; its tendency is generally toward redness. Specimens appearing quite black, are rendered distinctly purple or chocolate by heating to  $212^{\circ}$  F in a drying oven. Often when the substance first separates by addition of HCl, it is pure gray; this gray will often be changed to pink by simply heating to  $212^{\circ}$ . (This happens when a gray form is produced; if the grayness is due to admixed metallic silver, it is only removed by boiling with nitric acid.)

"The somewhat surprising change of color which is often seen when the crude substance is boiled with nitric acid (sometimes from dull dark gray to crimson) is due to three concurrent actions: that of the mere heat, the removal of the silver, and the breaking up of uncombined subchloride.

"It is not possible to dissolve out the normal chloride by a solvent like ammonium chloride from the photochlorides, leaving the subchloride behind. When red chloride is boiled with successive portions of strong solution of ammonium chloride in large excess, the material gradually diminishes

until, if the operation is continued long enough, there remains a small residue of warm gray color, which consists of metallic silver and dissolves without residue in nitric acid. If sodic chloride is substituted for ammonium chloride, the same result follows, except that the operation is greatly more tedious. If persevered in until the hot solution no longer removes traces of silver chloride, the residue consists of nothing but metallic silver.

"When silver chloride precipitated with excess of HCl is exposed to light, it becomes with time very dark. Cold, strong, nitric acid 1.36 sp. gr. extracts a trace only of silver.

"The principal action of light on AgCl (precipitated in presence of excess HCl) consists in the formation of a small quantity of subchloride which enters into combination with the white chloride not acted upon, forming the photochloride, and thus is able to withstand the action of strong nitric acid. At the same time a trace is formed, either of metallic silver or of uncombined subchloride, it is impossible to say which. After a certain very moderate quantity of photochloride is formed, the action of light seems to cease. This cessation has been noted by many observers, perhaps most exactly by Dr. Spencer Newbury.

"The nature of the product formed by the continued action of light on silver chloride seems to support the conclusion that the subchloride is combined with the whole of the normal chloride after the manner of lakes rather than in equivalent proportions. If the latter were the case it seems probable that the continued action of light would extend to much greater decomposition than it is found to do.

"The action of light in the formation of the so-called latent image will be examined in the second part of this paper."

"In a later paper<sup>1</sup> Carey Lea discusses the photobromide and photoiodide of silver.

The photobromide of silver is formed for the most part by the same reactions as the corresponding chlorine salt.

<sup>1</sup> Carey Lea: Am. Jour. Sci., [3] 33, 489 (1887).

"It is not however to be supposed that all reddish brown substances resulting from the action of reducing agents on silver bromide are the photosalt. By reduction, AgBr may yield a brownish colored form of silver, which, mixed with unreduced AgBr may form a substance resembling the photosalt, but having none of its properties. The two are easily distinguished by the action of cold nitric acid which added to a brown mixture of AgBr and Ag quickly dissolves the silver leaving AgBr. On the photosalt it has no action.

"A beautiful variety of photobromide is easily obtained by dissolving silver nitrate in ammonia and adding it to ferrous sulphate previously mixed with solution of soda. Then KBr is added dissolved in dilute sulphuric acid, until the mixture has a strong acid reaction.

"Sometimes this method gives immediately a fine purple, sometimes a brown product. But in either case, after washing and cautiously heating with dilute nitric acid, a beautiful purple results. Much care is needed in the nitric acid treatment or particles of yellow bromide will form.

"A specimen obtained in this way gave figures indicating 7.25 percent of subbromide. Each specimen however varies in composition, often very materially. I subsequently found it desirable in some degree to vary the method and to determine the best proportions in which the materials were used, to obtain a constant product. That which I prefer to use is as follows:

"Six grams of silver nitrate are to be dissolved in 200 cc of water and ammonia added until the precipitated oxide redissolves easily. Twelve grams of ferrous sulphate are dissolved in 200 cc of water and the silver solution is poured into this. Then 4 grams pure caustic soda dissolved in 50 cc of water are added, let stand a few minutes, then 5 grams of KBr dissolved in a little water. Finally, dilute sulphuric acid until the whole has a strong acid reaction. This product, well washed and then heated cautiously with nitric acid 1.36 diluted with five times its bulk of water, gives photobromide of a shade of royal purple, extremely beauti-

ful. Notwithstanding its fine color it proved to contain but little subbromide, not quite 1 percent (0.98 percent).

“Various other methods may be employed. Silver bromide may be dissolved in ammonia and be treated first with ferrous sulphate and then with dilute sulphuric acid. This method, which is very good with the chloride, is less available for the bromide because of the less solubility of the normal bromide in ammonia, so that although the product is good it is small in quantity. Very good results are obtained by dissolving silver phosphate, nitrate and probably almost any other salt of silver in ammonia, adding ferrous sulphate and after two or three minutes, hydrobromic acid. Potash bromide and cupric sulphate may be made to act on metallic silver in fine powder, but the product is contaminated with much copper, difficult to get rid of. When AgBr is treated with sodium hypophosphite a brown or brownish purple form of photobromide is obtained which seems to be more easily decomposed by nitric acid than most other forms of this substance. Potash or soda with oxidable organic substances, made to react on silver nitrate and then treated with HBr gives the photobromide. With soda and milk sugar or aldehyde a rose-colored or pink product is generally obtained.

“*Reactions.*—In strong solution of potassic iodide it dissolves and this solution by dilution lets fall pale yellow normal bromide. With a weaker solution it becomes somewhat lighter in color. With acid ferric sulphate there is no action in the cold, but with a few minutes' boiling the photobromide is converted into bright colored normal bromide. In sodium hyposulphite it dissolves, leaving a little black residue of silver. With ammonia the action first seems slower than is the case of the corresponding chloride and if the ammonia is poured over the photobromide in small quantity, it may seem to be without effect. But the photobromide shaken well up in a test tube with a large excess of ammonia is almost instantly blackened.

“Exposed to light, the red shades of photobromide

darken with great rapidity. Placed along side of the corresponding chloride, the contrast is very striking: a strong image forms on the bromide long before anything appears on the chloride; nevertheless, if these two films are thrown into a developing solution, the chloride on which nothing could be seen, gives a vigorous positive development, while the bromide which already showed a strong positive image develops a negative one. The details of this reverse development have been already considered in another paper.

"As respects the direct effect of light unaided by development, the contrast between its action on the normal haloids and on the photosalts is very striking. If a rose-colored photobromide and some normal bromide are exposed side by side the normal bromide (formed in presence of excess of alkaline bromide) darkens but very slowly while the photobromide is quickly acted on. I have seen deep purple photobromide change to brown all over its surface with less than five minutes exposure to diffuse light in the middle of a room, an amount of exposure which would scarcely have produced a visible effect on normal bromide formed in presence of excess of KBr.

"When photobromide is exposed to the spectrum, it shows the same difference in sensitiveness and darkens more rapidly than photochloride. But it gives little indication of color. When exposed under colored glass, photobromide gave distinct indications of reproducing colors, but much less favorably than photochloride. Under green glass it became bluish, under blue greenish, under yellow glass it bleached and under red glass the red of the photobromide remained unchanged.

"The most characteristic color of photoiodide of silver seems to be a fine rich purple. It is obtained in much the same way as the corresponding chloride and bromide, with this limitation, that an excess of alkaline haloid must not be present, as the photoiodide is quickly destroyed by it. The iodine salt differs much more from the bromide than does the bromide from chloride and two striking distinctions are, its

easy decomposition by its own alkaline salt, and its action with ammonia, as will appear beyond.

"A very easy and satisfactory method of obtaining the photoiodide is the following: Silver is to be reduced from the nitrate or chloride, in fine powder in any convenient way; I have usually employed Levof's method. To a solution of potash, iodine is to be added until the liquid becomes almost black. This iodine solution is to be diluted and poured over the silver by degrees, keeping the silver constantly agitated, until the whole mass becomes a clear bright purple.

"Any excess of silver present may be removed by boiling with dilute nitric acid, but this operation requires far more circumspection than in the case of the corresponding chlorine and bromine products. The acid (1.36 was used) must be diluted with twelve or fifteen times its bulk of water, and the boiling must be very short, otherwise the photoiodide is converted into normal yellow iodide.

"Another method by which it may be obtained is to add ammonia to silver nitrate in considerable excess and to pour this into solution of ferrous sulphate. Potassic iodide is dissolved in a very dilute sulphuric acid and added till the mixture has a sharp acid reaction. It is necessary to observe that the KI added must be somewhat short of a proportion equivalent to that of the silver. Any excess of silver may be removed in the manner already explained.

"Different specimens of the purple product in this way obtained gave various amounts of  $\text{Ag}_2\text{I}$  from 0.64 percent to 4.63. The same remark made as to the meaning of these determinations in reference to the other haloids, applies to this.

"The method of roasting silver oxide until it is black and acting on it with the hydrogen acid of the halogen, which works well in the case of the chloride, does not answer well for the iodide.

"When silver iodide is boiled with solution of sodium hypophosphite, it gives a brown product, evidently indicating that reduction to some extent has taken place; the

hypophosphite solution may or may not show traces of iodine. The color of the silver iodide may show a very marked darkening, and yet the solution may give no trace of iodine by the most delicate reagents.

"This was very difficult to explain until I found that silver iodide has the property of taking up and retaining small portions of iodine, a reaction not very surprising in view of the tendency I have found in silver haloids to take up foreign substances of very various natures, and also of the facility with which iodine is taken up by alkaline iodides. This property in silver iodide was verified by shaking up portions of freshly precipitated and still moist AgI with iodine solutions. Alcoholic solution of iodine diluted until it has a pale sherry wine color is quickly decolorized by AgI, and the same thing happens with a very dilute solution of iodine in KI, which in a few minutes becomes as colorless as water.

"This reaction I found particularly interesting, for it not only explained the action of hypophosphite in the case just mentioned, but also gave a clue to the cause of a phenomenon I observed more than twenty years ago, and which then and long afterwards seemed to me an unanswerable argument in favor of the physical nature of the latent image.

"At the time referred to I formed films of pure silver iodide entirely isolated from foreign matter, by reducing metallic silver on plates of ground glass, iodizing them with alcoholic solution of iodine, or with Lugol's solution, then washing most thoroughly under a tap for hours. When these films of silver iodide were exposed to light, they received an invisible image which could be developed. But these invisible images, if the plates were laid aside in the dark, had the property of fading out in a few days or weeks, then could no longer be developed, but the film could receive a fresh image. This seemed an unanswerable proof of the physical nature of the latent image at least on silver iodide. The argument was: If the production of this latent image is the result of chemical action involving the loss of iodine by the silver salt, how then is this iodine recovered when the



image fades out? If it is formed of subiodide, where does this latter substance get back its iodine to return to the normal form, as it unquestionably does?

"No answer could be given then or after, and this experiment, repeated and confirmed by others, has always seemed the strongest support of the physical theory. When, however, it appears that silver iodide, can take up iodine and hold it, the course matters follow becomes evident. By the action of light a very small quantity of subiodide is formed, and combines with the normal to form photoiodide. The iodine set free evidently does not pass off but remains combined with neighboring molecules of AgI, and in the dark gradually re-combines with the photoiodide re-converting it to normal AgI. In this retention the lower tension of iodine as compared with bromine and chlorine no doubt plays its part.

"In thus explaining away the fading out of the latent image on silver iodide, the last argument in favor of the physical theory is destroyed, while the chain of proof supporting this new explanation, that the latent image consists of normal haloid combined with its own subsalt, remains unbroken.

"*Reactions.*—When ammonia is poured over purple photoiodide of silver, the color quickly passes to a salmon and then, even after some days, seems to undergo no further change. Of separation of metallic silver as in the case of the corresponding chloride and bromide, there is no trace. In sodium hyposulphite it dissolves slowly, leaving a slight but distinct residue. Dilute nitric acid mixed with dilute solution of KI slowly but completely converts it to normal silver iodide. Light acts slowly upon it, changing the color to greenish gray."

"In another paper Carey Lea discusses the identity of the photo salts of silver with the material of the latent photographic image. The portion having to do with the behavior of sodium hypophosphite has already been quoted.<sup>1</sup> I now quote another portion of the same paper.<sup>2</sup>

<sup>1</sup> Bancroft: Jour. Phys. Chem., 13, 563 (1909).

<sup>2</sup> Carey Lea: Am. Jour. Sci., [3] 33, 480 (1887).

"If we expose silver chloride precipitated with excess of HCl to light, we get a deep purple-black substance which boiled with dilute nitric acid gives up a little silver, at the same time somewhat lightening in color and forming a dull purple material which closely resembles some of the forms of photochloride described in the first part of this paper, mostly those produced by the action of sodic hypochlorite or of ferric chloride on metallic silver: it shows the same reactions with ammonia that they do. The brighter colored photochlorides are not formed by the action of light on silver chloride.

"But these brighter colored chlorides can also be shown to be formed through the action of light. Most salts of silver darken by exposure, and when these dark products are treated first with HCl, and then after thorough washing, are boiled with dilute nitric acid, we can obtain results perhaps as varied as those which I described in the former part of this paper, as arising from purely chemical action.

"Silver oxalate exposed for two days to sunshine, covered with water and with frequent agitation, changed to a deep brownish black which by treatment with HCl became a little lighter. When this product was washed and boiled with strong nitric acid, it acquired a fine deep copper-red color, the acid taking up silver. This red substance dissolved in ammonia readily, leaving a small amount of black residue; the same with sodium hyposulphite.

"(This examination, made a year ago, has recently been repeated with a view to obtaining a quantitative determination of the proportion of  $\text{Ag}_2\text{Cl}$  contained in the red product. The exposure was for about a day, the oxalate at the end of the exposure seemed absolutely black. After treatment with HCl it assumed a purple-black shade. After thorough washing and boiling with dilute nitric acid, which removed a large quantity of silver, perhaps 12 or 15 percent of the entire quantity, it had a fine lilac-purple color. Analysis showed that it contained about one-half of the one percent of subchloride, or more exactly, 0.45 percent  $\text{Ag}_2\text{Cl}$  was found.)

"The red chloride thus obtained from silver oxalate, not only closely resembles the red chloride obtained by means exclusively chemical, but shows the same behavior to reagents. Treated with ammonia it dissolves leaving a black residue. The formation of this residue takes place precisely in the same manner with both substances. As fast as the material dissolves the liquid becomes clouded and an extremely fine black substance seems to form within it, which gradually falls to the bottom. Treated with solutions of the alkaline haloids, the red chloride derived from exposed silver oxalate remains unchanged after 24 hours' contact with potassic chloride and becomes paler and more lilac under potassic bromide; under potassic iodide becomes gray. These reactions correspond with those of the photochloride.

"Silver phosphate belongs to the more sensitive silver salts and easily darkens in the sunlight. In a few hours it becomes greenish all through, after which further exposure produces little visible effect. This product becomes with HCl quickly gray, and by treatment with nitric acid after washing, light pink. Silver tartrate by exposure to sun became quite black. With HCl this changed to reddish gray or dull pink. This product, well washed and let stand with cold nitric acid 1.36, became first lavender and then light pink. Silver carbonate by prolonged exposure became greenish black, and with the above treatment yielded a dull pink photochloride. Silver pyrophosphate even by several days' exposure to winter sun did not blacken, but assumed an ochreous or buff shade. With HCl this passed to a sort of salmon pink and by heating a few minutes with dilute nitric acid, to a beautiful copper shade. Silver acetate was singularly little affected by sunlight, it looked blackish, but on closer inspection was found to be little altered. By the same treatment as above it yielded a pale pink photochloride. So far as examined, all silver salts thus treated yielded pink or red photochloride.

"These facts may serve to show the identity of the photochloride with the principal product of the continued

action of light on silver chloride and on other salts of silver, subsequently converted into chloride. I should wish, however, to use this word identity in a somewhat limited sense. When the photochlorides are formed by different methods without the aid of light hardly any two forms can be considered absolutely identical: they differ in color and proportion of subchloride, as already often mentioned, but they also differ in other respects, especially in resistance to reagents. Some forms are far more easily destroyed by nitric acid: those obtained by the action of sodium hypophosphite are among the most easily destroyed by nitric acid. There is variation, too, in the degree of their resistance to ammonia.

“Very similar differences are found in the stability of the photochlorides obtained by the action of light: some are much more readily attacked by nitric acid than others. The product obtained by the action of light on silver chloride resists ammonia more strongly than that obtained by the action of HCl on exposed silver oxalate. This last is quickly attacked. Generally, I think the dark colored forms are the most stable. At a future time it may perhaps be possible to distinguish more exactly between these varieties.”

“In a fourth paper Carey Lea<sup>1</sup> takes up the combination of silver chloride with other metallic chlorides.

“In a series of papers lately published, I have expressed the view that the principal and characteristic product of the action of light on the silver haloids is a combination of the haloids with a small proportion of its own subsalt. Such was the result of my analyses, and the opinion was supported by the tendency which the silver haloids were found to have to unite with foreign matters, such as many dyes and other organic compounds, showing the existence in these silver haloids of a singular disposition to form compounds outside the law of atomic proportion.

“This opinion finds additional support from another argument and a more nearly parallel case, for it appears

---

<sup>1</sup> Am. Jour. Sci., [3] 34, 384 (1887).

that silver chloride (and doubtless the other silver haloids) can unite with small quantities of certain other metallic chlorides. That an actual combination, though one quite outside of atomic proportion, takes place, is proved by two facts; first, that the chloride with which the silver haloid unites, though soluble in water, is not removable by water; again, that the properties of the haloid are markedly changed.

"This combination with another metallic chloride furnishes a much nearer parallel case to the photosalts than does the combination with a dye. For if silver chloride is found to be capable of taking up a small quantity of ferric or other chloride, and of retaining it so firmly that it cannot be removed by washing, and only with some difficulty by HCl, we are thereby justified in admitting that the silver haloid may easily form a stable combination with a small proportion of its own sub-salt.

"In all these compounds the tendency seems always to the combination of a large proportion of the silver haloid with a small one of the other substance, whether the latter is a dye, another chloride, or a silver sub-salt—all show the same disposition, so that I am justified in saying that my view of the nature of the photosalt is supported by the existence of many analogous bodies.

"The compounds of silver chloride and other metallic chlorides form when the silver haloid is in presence of their solutions at the moment of its precipitation.

"*AgCl with Fe<sub>2</sub>Cl<sub>6</sub>.*—When to dilute HCl is added, first, ferric chloride, then solution of silver nitrate, the silver chloride thrown down is not white but buff-colored. The ferric chloride which has united with the silver chloride cannot be removed by washing. Agitating with HCl dissolves out part, but not all. It is very interesting that this small quantity of iron profoundly affects the sensitiveness of the silver salt to light. To make an accurate comparison, two solutions of silver chloride were precipitated, the one from pure HCl, the other from HCl mixed with Fe<sub>2</sub>Cl<sub>6</sub>, both were shaken up with HCl, so as to remove all the more

loosely combined iron salt from the one, and to place the two under exactly corresponding conditions, the presence of the iron salt alone excepted. They were then washed. When both were exposed together to light, the difference was extraordinary. The normal AgCl had passed to a full violet, with an exposure which produced on the other scarcely any visible effect. Even after an exposure to diffuse light of two hours, the difference was still very striking.

*“AgCl with CoCl<sub>2</sub>.—*When cobalt chloride is added to HCl, and then solution of silver nitrate, a pinkish precipitate is obtained, whose sensitiveness to light is less than that of normal silver chloride. But the diminution of sensitiveness is far from being so great as in the case of AgCl precipitated in presence of ferric chloride.

*“AgCl with other Chlorides.—*Both nickel chloride and manganous chloride attach themselves to silver chloride when the latter is precipitated in their presence. Cupric chloride seems to have no such tendency. Gold chloride shows a marked tendency to attach itself to AgCl. When silver nitrate is added to dilute HCl with which a little auric chloride has been mixed, the precipitated AgCl has a reddish shade. Continued washing renders this paler but does not seem to remove it. After ten decantations, each with a hundred volumes of water, the color imparted by the gold is still visible. What influence the auric chloride has on the sensitiveness of the silver salt is not easy to say, as the gold present is quickly reduced by exposure to light, so that the AgCl, instead of passing to violet and chocolate as in the case of pure AgCl, gradually darkens to a pure black.

*“The facility with which these compounds are formed explains the necessity in analytical determinations of silver as chloride, for digestion for a considerable time with dilute HCl. Even then it is very doubtful if all the foreign chloride is removed. Ferric chloride is especially adherent. Indeed it has been said that when iron once comes into contact with silver it is next to impossible to get rid of it, and the reason lies in the strong affinity which the two chlorides have*

for each other. Accordingly much silver nitrate sold as absolutely pure contains iron, evidently carried down with the silver chloride when precipitated in the manufacture.

"These reactions of AgCl are interesting in several ways. They support the theory I have proposed, of the photosalts being compounds of two chlorides of silver not combined in definite proportions, by establishing the existence of other analogous compound chlorides.

"Again, the sensitiveness to light of AgCl is so strongly modified by mere traces of ferric chloride, that evidently a quantity of the latter substance, quite too small to visibly affect the color of the AgCl, may materially change its sensitiveness, thus affording an illustration of what takes place in the latent image, where the presence of a quantity of Ag<sub>2</sub>Cl, too minute to be visible, is sufficient to powerfully influence the substance combined with it.

"It also furnishes an explanation for a well-known fact that has hitherto seemed anomalous. It has long been known that a trace of mercuric chloride suffices to greatly diminish the sensitiveness of silver chloride to light. This isolated fact now becomes simply one of a series; AgCl combines with a small proportion of mercuric chloride just as it does with other metallic chlorides, those of the iron triad for example, and does not give it up when washed.

"Debray (quoted in Gmelin-Kraut, article Silver), has indeed expressed the opinion that the mercuric chloride can be entirely removed by washing with water. To fix this point I have sought for a convenient means of detecting small quantities of mercuric chloride in presence of AgCl, and have found it in a solution of stannous chloride made strongly acid with HCl. Pure AgCl is not darkened by this reagent, provided that light is carefully excluded, but if mercuric salt is present, a brown or brownish black coloration results. Long washing has with me wholly failed to remove the mercuric salt. I therefore look upon the combination as one of considerable stability.

"All these combinations diminish the sensitiveness of

AgCl, but this effect is greatly stronger with those chlorides which easily part with one equivalent of chlorine, as we saw in the case of ferric chloride. Mercuric chloride acts in the same energetic way. It seems indeed that the reduction of sensitiveness in these cases is somewhat out of proportion to the amount of chlorine that could be yielded up by the trace of the foreign chloride which is combined with the AgCl. But this is, perhaps, to be explained by this trace of chlorine holding in check the initial movement toward reduction.

"It is worth observing that experiment and observation are constantly tending to enlarge the number of substances with traces of which the silver haloids show themselves capable of uniting, with great modification of their properties as a consequence.

"The reduction of sensitiveness that results from the presence of certain other chlorides, will undoubtedly in the future be of great value in aiding toward a solution of the problem of rendering permanent photographic images in natural colors. Indeed, it was Poitevin, I think, who found that his colored images resisted light better when treated with lead chloride and dextrine. The property was observed, but the nature of the action remained obscure. We now see its explanation in the tendency of the lead salt to check reduction. Zinc chloride I found available like lead chloride, to regenerate white silver chloride by the action of light on colored photochloride, and thus to give aid toward that very difficult requirement in heliochromy, that white light shall express itself by producing white."

Lüppo-Cramer<sup>1</sup> has made some observations on the behavior of the latent image which make him believe that the latent image is a solid solution.

"The latent image on fine-grained and on ordinary dry plates is completely destroyed and physical development is prevented if the plates are first fixed in a hyposulphite

---

<sup>1</sup> Phot. Correspondenz, 43, 388, 433 (1906).



solution and are then bathed for a few minutes in solutions which dissolve both silver and silver bromide. For this purpose we may use a mixture of sulphocyanates with strong acids or a mixture of sulphocyanate or hyposulphite with bisulphite. A solution of 10 grams hyposulphite and 20 grams potassium pyrosulphite ( $K_2SO_3 \cdot SO_2$ ) in one hundred parts of water destroyed the previously fixed latent image completely in 10-15 minutes even when the exposures had been so long that the check plates were much over-developed.<sup>1</sup> If a little more time is given, slightly acid fixing baths destroy the latent image. In fact, four years ago<sup>2</sup> I published the fact that the latent image in a collodion emulsion is distinctly weakened by a preliminary fixing, in case the fixing bath contains bisulphite.

"We thus find completely analogous reactions for the negative image after the silver has been removed, for the visible image, and for the latent image. Since those substances, which we have hitherto considered as subhalides of varying composition, are readily destroyed by any solvent which attacks silver and silver bromide, it seems to me that we must be dealing with a solid solution of silver in silver bromide, since it is not decomposed either by reagents which only dissolve silver, or by reagents which only dissolve silver bromide. It is only on the assumption of a solid solution or of a compound like the lakes, that it is easily intelligible how the products, resulting from the action of light on the silver halides, can show such remarkably complicated reactions with solvents of silver bromide on the one hand, and with solvents of silver on the other hand, as have been described by Eder recently in his magnificent paper<sup>3</sup> on "The Nature of the Latent Image."

"A real subhalide of silver would probably behave like the mercurous compounds. Mercurous iodide or bromide

<sup>1</sup> Bisulphite retards very much the fixing in hyposulphite; neutral sulphite acts the same way.

<sup>2</sup> Phot. Correspondenz, 38, 359 (1906).

<sup>3</sup> Sitzungsber. Akad. Wiss. Wien, 114 IIa, 1159 (1905).

gelatine, when fixed<sup>1</sup> without exposure to light, leave behind a brownish-black residue, which dissolves completely in chromic acid or nitric acid because real subhalides, when fixed, decompose completely into metal and into the normal halide, which latter dissolves.

“Lorenz<sup>2</sup> was apparently the first to suggest the solution of silver in silver bromide as an explanation of the latent image.<sup>3</sup> We can study the behavior of the hypothetical solution of silver in silver bromide especially easily on a negative from which the silver has been removed with chromic acid. It is not decomposed by hyposulphite and is also indifferent to oxidizing agents which dissolve silver readily. Of course strong oxidizing agents such as the well-known chromic acid mixture or very strongly acidified permanganate solutions, will take a good deal of silver out of the residue on the negative; but no oxidizing agent will remove the last traces of the silver (with the exception of bromine and iodine which combine quantitatively with the silver to form silver bromide and iodide). This reminds one of the fact that the last traces of metals cannot be removed from their alloys, of silver with gold for instance.<sup>4</sup>

“A very important and striking experiment and one that shows that traces of silver dissolved in silver bromide affect the solubility of the latter, is the phenomenon, discovered by Englisch and confirmed by Eder, that ammonia dissolves the unexposed portions of the image on a silver bromide collodion plate faster than the exposed portions, so that it is possible to develop, after a fashion, with ammonia. I was also able to perform this interesting experiment without

---

<sup>1</sup> Owing to the readiness with which mercuric hyposulphite compounds decompose, it is advisable to add a good deal of bisulphite.

<sup>2</sup> Cf. *Phot. Correspondenz*, 38, 166 (1901).

<sup>3</sup> It is also possible to assume the existence of a solid solution of subhalide in normal halide; but it seems to me less forced to assume that we have silver dissolved in normal halide.

<sup>4</sup> Baur also makes use of this analogy when pointing out that dilute nitric acid bleaches his photochloride to a pinkish-red but that the last percent of subchloride is very resistant even to concentrated nitric acid.

difficulty. I have not yet been able to do it with gelatine plates or with other solvents of silver bromide; but the curious behavior of silver bromide when a dichroic fog is formed seems to be a proof that small amounts of silver are also sufficient to cut down the rate of solution in other solvents of silver bromide. The experiments on dichroic fog and on pseudo-solarization are intelligible only in case traces of silver prevent the solution of the silver bromide which is essential to the production of a colored fog.

"If these slightest traces of reduction affect the rate of solution of the silver bromide grain so much, it is quite intelligible that the relatively large amount of silver, in solid solution in the negative image after the free silver has been removed, should prevent completely the solution of the silver bromide in which it is dissolved. It is clear that we have the same state of things in the latent image and in the visible decomposition of the photohalides. There is always a certain amount of silver in solid solution in the silver bromide, and this silver resists the action of reagents which dissolve silver and the action of fixing agents. When we have present, simultaneously, substances which dissolve silver and silver bromide, the silver of the latent image or of the visible image is attacked much more readily than the silver held by silver bromide in the negative image.

"The remarkable influence of the size of the grain on the photochemical decomposition of the silver halides becomes quite intelligible if we assume the existence of solid solutions of silver in silver halide. The existence of a definite subhalide,  $\text{Ag}_2\text{Br}$ , etc., has always been doubted and it is a substance to which one can attribute any property that one happens to need for an explanation. Even if such a compound were formed on exposure to light, that does not explain why fine-grained and coarse-grained silver bromide should act fundamentally differently in regard to oxidizing agents. Quite accidentally, most photochemists have worked chiefly with silver bromide having a fairly coarse grain such as is obtained by precipitation from concentrated aqueous solu-

tions, the silver bromide of the collodion emulsion, or that of the ordinary highly-sensitive dry plates. Except for this, it is probable that no one would have considered the visible blackening of silver bromide as due to a sub-bromide. In very fine-grained films the photochemical decomposition product behaves just like metallic silver.

"It is very improbable that a photochemical reaction such as the reduction of the silver bromide, should vary with the size of the grain, giving metallic silver with a fine-grained emulsion and stopping at the subhalide with the coarse-grained emulsion. It is easy to see that the behavior of the photochemical decomposition product of silver bromide may vary with the size of the grain if one assumes that silver is formed in both cases but that it behaves differently when dissolved in the relatively large mass of silver bromide constituting the coarse grain than when dissolved in a small grain. One may assume that an almost complete decomposition takes place inside the very fine grains, since the blackening disappears so readily in nitric acid or chromic acid. When treated with these reagents after a long exposure to light, there only remains the infinitesimal trace of silver in solid solution which can be detected by physical development and which doubtless constituted the innermost part of the original silver bromide grain.

"With increasing size of grain we get different phenomena as a result of photochemical decomposition. The silver is distributed through a much larger mass of solid solvent, the dissociation pressure of bromine is different, the silver dissolved in this large complex is very resistant to oxidizing agents, though this disappears when the silver is set free from its solvent, silver bromide, by a reagent which dissolves this latter substance. Such solvents as hyposulphite or sulphocyanate cannot be used by themselves, before the treatment with an oxidizing agent. The two must be applied simultaneously because otherwise the silver dissolved in the solid silver bromide keeps this latter from dissolving. It is only when the grain is extraordinarily fine that it is possible

to destroy what is left of the latent image after a preliminary fixing by means of chromic acid or nitric acid alone. If the preliminary fixing is omitted, the latent image withstands treatment with chromic acid even in the case of the so-called grainless silver bromide emulsion.

"The latent and developable image, as I have said, is extraordinarily resistant to oxidizing agents while the visible blackening is readily destroyed, a phenomenon which is especially striking in the case of the mercury halides. That would not justify us in postulating any real chemical difference between the substance of the latent image and that constituting the direct blackening. We must rather distinguish between the outer and the inner portions of the grain. It is easy to see *a priori* that reduction may be carried further on the surface than in the interior of the grain and this is confirmed in a striking way by my experiments on the peculiar behavior of the developed image. The experiments with different oxidizing agents show clearly that, with increase of oxidizing potential, the substance which is to dissolve the silver penetrates farther and farther into the grain and overcomes more and more the resistance of the silver held in solid solution. There is always a resistant residue, a kind of compound of silver with silver bromide, which can be converted into silver halide by bromine or iodine but which can only be dissolved by other oxidizing agents when the solution also contains something which will dissolve silver bromide.

"When a very fine-grained silver bromide plate is exposed to light until there is an intense visible blackening, the product is almost entirely silver which dissolves readily. Nevertheless, a considerable amount of silver held in solid solution is obtained when these fine-grained plates are developed after such an exposure. It is true that the residue of the developed image left after treating with chromic acid is less the finer the grain of the original silver bromide; but even the so-called grainless silver bromide emulsion leaves a distinct yellowish-brown residue as I have previously pointed out.<sup>1</sup>

<sup>1</sup> Phot. Correspondenz, 42, 319 (1905).

“Silver chloride gelatine behaves exactly like the bromide in so far as the composition of the developed image is concerned. After desilverizing with nitric acid or chromic acid there remains a brown residue which is somewhat different in shade from that on silver bromide plates; but which behaves towards hyposulphite, developers,<sup>1</sup> etc., exactly like the corresponding solid solution of silver in silver bromide. The desilverized developed image on silver chloride gelatine is light-sensitive like the one on silver bromide. Liesegang<sup>2</sup> has put forward a hypothesis that the different developers form subhalide or metal depending on their reducing potentials. This view is not confirmed by my experiments with weak and strong solutions of developers. As far as chemical behavior is concerned, it is always the same substance which is produced on development. It may also be mentioned that Liesegang is wrong in assuming that the variations in color obtained in the reduction of silver chloride are characteristic of this substance. If silver bromide is sufficiently fine-grained, we may get similar variations in shades. It is easily seen that a definite rate of reduction may determine the composition of the solid solution of silver in silver bromide or chloride and may therefore affect the color of the precipitate. In connection with this it is important to note that silver bromide, precipitated from aqueous solution, is reduced straight to silver. When I treated 50 grams of freshly precipitated silver bromide with an amount of developer not sufficient to cause complete reduction, treatment with hyposulphite and then with nitric acid left an insoluble residue which was a clear brown, like the residue from an emulsion; but there was so little of it that I did not make any further study of it. This is another illustration of the difference between emulsified and precipitated silver halide, to which I have repeatedly called attention. If we assume the forma-

<sup>1</sup> The photochloride gelatine plates of Baur [*Eder's Jahrbuch der Photographie*, 19, 677 (1904)], and the subbromides which I prepared synthetically are easily reduced completely.

<sup>2</sup> *Eder's Jahrbuch der Photographie*, 18, 490 (1904).

tion of solid solutions of the metal in the halide, we see that, of the three halides, silver iodide has the least tendency to form such solutions.

"The blackened product in a solution chloride emulsion resists the action of oxidizing agents much more than does the corresponding product in a silver bromide emulsion having a grain of the same size. This shows that the solid solution in silver chloride is more stable than the corresponding silver bromide one. If a solvent for the halide is present, the silver is dissolved more rapidly from silver chloride by nitric acid than from silver bromide. It is possible, however, that the same amount of silver may have a greater coloring power when dissolved in silver chloride than when dissolved in silver bromide, in which case it would not be justifiable to postulate equal amounts of silver from equal intensities of blackening. My experiments justify the belief that the subhalide hypothesis must give way to the assumption of dissolved silver nuclei, or that the silver nucleus theory, as modified by me, is at least as good as the subhalide theory. In this case the phenomenon of the varying coloring power of silver with the varying nature of the halide opens a new field for investigation. Thus, the decrease in intensity on fixing will not be due to the decomposition of subhalide into halide which dissolves the residual metal, but will be explained by the assumption that silver dissolved in a solid silver halide is much more deeply colored than the same amount of silver after the halide has been dissolved away."

In a later paper<sup>1</sup> Lüppo-Cramer discusses the photohalides of Carey Lea with reference to their being adsorption compounds of silver halide and silver.

"The analogy which Carey Lea has found between the lakes and the compound of the 'subchloride' with the normal chloride appears as a very striking one when we consider the coloring of the silver chloride gel by colloidal silver. We have here another illustration of the dyeing with an inorganic

<sup>1</sup> Lüppo-Cramer: *Phot. Correspondenz*, 44, 327 (1907).

substance, the theory of which has been worked out by Zsigmondy and by Biltz. Zsigmondy discovered that colloidal gold dyes mordanted wool and forms a red-colored lake with freshly precipitated aluminum hydroxide. Biltz proved that animal and vegetable fibers (silk, wool, cotton), can be dyed with inorganic colloids (selenium, vanadium oxide, molybdenum blue, arsenic sulphide, antimony sulphate, etc.) and that the fibers may be replaced by an inorganic hydrogel ( $\text{Al}_2\text{O}_3$ ,  $\text{ZrO}_2$ ,  $\text{Fe}_2\text{O}_3$ ,  $\text{SnO}_2$ ) without changing the quantitative course of the adsorption of the dyes. Biltz was also able to color cotton and the hydrogel of aluminum with colloidal silver (col-largol) so that there is a distinct probability that one could color silver halide with colloidal silver. It is therefore not necessary to assume with Carey Lea that there is a direct reduction of silver chloride by silver with formation of subhalide when silver chloride is boiled with colloidal silver. When photohalide is formed by simultaneous coagulation of the colloidal solutions of the components ( $\text{AgCl}$  or  $\text{AgBr} + \text{Ag}$ ) by electrolytes, we must be dealing with an adsorption compound of silver halide and silver because it is impossible to see how a subhalide could be formed when the mixture of the two colloids, silver bromide and silver, is coagulated by dilute acids or neutral salts.

"It is very surprising to me that Carey Lea should look upon it as proved that the pure subchloride is readily decomposed by nitric acid. I have not succeeded in finding any reason why Carey Lea thought it necessary to assume the existence of a subchloride soluble in nitric acid. The assumption of a subchloride instead of silver is useful as a working hypothesis only so long as one considers the subchloride as insoluble in nitric acid. If we are going to assume with Carey Lea that the subchloride is able to resist oxidizing agents only after combining with the normal halide after the manner of a lake, we might just as well make the same assumption in regard to metallic silver.

"In the experiments on heliochromy, Carey Lea found that the pink photochloride, which never contained more



than a few percent of 'subhalide,' was the most suitable for reproducing colors. This was confirmed by Günther. It is important to notice that Günther obtained the best heliochromatic effects with the photochloride plates which he prepared by adding silver to silver chloride. This makes it plausible to compare, as Carey Lea did, the added colloidal silver to a dye which is adsorbed in small amounts and not at all in stoichiometric proportions. When considered as a dye, silver acts as an optical sensitizer and the numerous shades of color in which colloidal silver may appear, may be the chief factor in the different behavior of the single photochlorides when exposed to the spectrum."

Günther also finds that when he chlorinates colloidal silver he gets the best heliochromatic results with a photochloride containing 98 molecular percents of chlorine. We are therefore forced to consider this as AgCl with about 2 percent excess of silver. We have the same products as when we color AgCl with 2 percent silver, and it is therefore natural that we get the same heliochromatic effects regardless of the method of preparation.

Günther's experiments on chlorination and bromination seem to furnish the proof that the added halogen does not combine with the silver to form the different, hypothetical, intermediate products ( $Ag_2Cl$ , etc.); but that it forms the normal halide direct and that the silver which is not chlorinated remains as silver and is entangled when the precipitate coagulates. On treatment with nitric acid all the silver dissolves except that portion which is adsorbed by the silver chloride or bromide (only a few percent according to Günther and to Carey Lea). I convinced myself of the accuracy of this assumption by brominating colloidal silver with an amount of bromine just sufficient to form  $Ag_2Br$  if that substance existed. Fourteen grams of silver nitrate were reduced by Carey Lea's method, with dextrine and caustic soda. By precipitation with alcohol most of the electrolyte was removed; the 5 percent aqueous solution of colloidal silver-dextrine was treated in aqueous solution with 3 grams

of bromine (= 0.5 molecule), which caused no coagulation. There are always losses in preparing and purifying colloidal silver because of adsorption and because some alkali remains in the silver hydrosol in spite of the precipitation by alcohol. The bromine may also react to some extent with the alcohol, with the dextrine, or with the oxidation products of the latter. Consequently one cannot expect quantitative accuracy from these experiments. Nevertheless, we get a fairly convincing proof of the accuracy of the hypothesis from the weight of the beautiful blue-violet photobromide and from the weight of the silver which is dissolved by cold, concentrated nitric acid after the brominated product has been coagulated by sulphuric acid. Potassium bromide precipitated 6.9 grams AgBr from the silver nitrate solution while the weight of the photobromide was 7.6 grams. The theoretical yield of silver bromide from 14 grams AgNO<sub>3</sub> is 15.4 grams, so that the result seems to be sufficiently accurate under the circumstances to justify my view that colloidal silver reacts with a halogen to form normal halide, which is colored by a small amount of the excess silver, thus forming photochloride, while the rest of the silver is there as metal.

“When the colloidal particles of a mixture of the hydrosols of silver bromide and silver begin to coagulate under the influence of electrolytes, there is formed an extraordinarily fine-grained, but distinctly reddish photobromide which is converted by concentrated nitric acid into silver bromide. A similar phenomenon occurs with silver chloride but the decolorizing by nitric acid ceases at a much lower limiting size of particles than is the case with silver bromide. When in a very fine-grained state, the photohalides do not resist oxidizing agents; they are able to do so only when they change from sols to gels.

“This is in complete accord with my experiments<sup>1</sup> on silver bromide and silver chloride emulsions. I found that the photochemical darkening disappeared completely and

<sup>1</sup> Lüppo-Cramer: *Phot. Correspondenz*, 43, 28 (1906).

instantaneously when emulsions of colloidal silver halide were treated with oxidizing agents while, with coarse-grained emulsions, there was no change of color even when boiling concentrated nitric acid was allowed to act for quite a while. From this I concluded that silver was formed by the action of light in both cases; but that the behavior of silver varied with the size of grain of the halide. With increasing size of grain the silver was dissolved in a larger amount of solid solvent and was therefore less readily attacked by chemical reagents. Of fundamental importance for the theory of the photohalides is the following experiment suggested by the behavior of mixtures of the hydrosols of silver and silver halide when coagulated by electrolytes.

“Plates with colloidal silver bromide gelatine were exposed under a 5 percent nitrite solution until quite dark. The color was bleached at once by 2 percent solutions of chromic acid, nitric acid, etc. If the colored films are removed from the glass and are heated with dilute sulphuric acid until the photobromide coagulates, even boiling, concentrated nitric acid has no effect. I obtained similar results by treating pure silver bromide sols in a like way but the color was not so marked because the light does not have access to the silver salt so well as in the gelatine film.

“It is therefore not necessary that the silver reduced by the light should be inside a large molecular complex during the exposure in order to become chemically resistant. The coagulation by the colloidal particles to a gel after the exposure will have the same effect. It is quite clear that the purely chemical nature of the reduction product cannot be changed by the coagulation of the exposed silver bromide. Since the behavior of the exposed silver bromide is the same as that of the photobromide obtained, without the action of light from  $\text{AgBr} + \text{Ag}$ , both before and after the coagulation by electrolytes, this proves that the product obtained by exposure to light can only be silver, which loses its characteristic instability towards nitric acid by forming a compound with

the normal halide. This is also the assumption made by Carey Lea in regard to his 'subhalide.'

"If we examine the numerous methods of making photohalides, as given by Carey Lea, with an eye to determining whether they permit the assumption of an adsorption compound between normal halide and silver, we find that in most cases this may be done very easily. There is no difficulty, for instance, in considering from this point of view all the methods in which silver halide is reduced or colloidal silver is treated with hydrochloric acid."

"Carey Lea's experiments, and my own as well, show that the latent image can be nothing else than a photohalide. Although all of Carey Lea's many experiments on photohalides can be explained on the assumption of a solid solution of silver in silver halide, there are nevertheless some methods of preparing photohalides which call for a few words of comment. My decisive experiment on the conditions for obtaining the reaction between silver halide and silver called for silver in colloidal form. We cannot postulate the presence of colloidal silver off-hand, when we prepare photochlorides by chlorinating silver foil, in the preparation of Becquerel's photochromes for instance. Although it is difficult to include this method under the general point of view, it does not seem to me so serious a matter as to constitute an argument against the correctness of considering photohalides as adsorption compounds. According to Becquerel the thicker, violet, photochloride films on his metallic silver plates were only  $1/1500$  mm in thickness. The chlorinating medium would probably first dissolve the surface of the silver and thus bring about a state of things in which the silver could combine with the chloride just as the colloiddally dissolved silver does with the solid hydrosol."

"In order to support the view that the photohalides are a compound of subchloride with normal halide, Carey Lea has written a paper<sup>1</sup> entitled 'Combinations of Silver

<sup>1</sup> Quoted in full, *Jour. Phys. Chem.*, 16, 47 (1912).

Chlorides with Other Metallic Chlorides,' in which he shows that the chlorides of iron, cobalt, nickel, manganese and gold combine with the silver salts to a limited extent and not in stoichiometrical proportions, just as is the case with dyes and with his subchlorides. This dyeing of the silver chloride is most noticeable with ferric chloride. Instead of treating precipitated silver chloride with ferric chloride, the experiment succeeds better, as carried out by Lea, when silver nitrate is precipitated jointly by ferric chloride and hydrochloric acid. My experiments on the tanning and on the adsorption compounds of gelatine showed that the adsorption of the different inorganic tanning agents was due to the gelatine combining with the hydrosols of the oxides of the salts in question, the sols having been formed by hydrolysis. This suggested to me that perhaps the nature of the anion had little effect in the cases of adsorption described by Lea, and that perhaps the important factor was the tendency of the salts to hydrolyze. This view is confirmed by the fact that ferric chloride and ferric alum behave identically in respect to combining with silver chloride. In relatively concentrated and acid solutions, the silver chloride is only slightly discolored by iron salts. The greatest amount of impurity is not obtained by precipitating with hydrochloric acid, as Carey Lea did, but by using sodium chloride and precipitating with dilute solutions which have previously been heated until the more intense color and the slight opalescence show that the iron salts are hydrolyzed. Both ferric chloride and ferric alum yield a silver chloride, which is colored a clear brown and which cannot be freed from the adsorbed iron salts by washing with water or with dilute acids. The other salts, with which Lea obtained colored silver chloride compounds, are probably adsorbed as oxide hydrosols owing to their tendency to hydrolytic dissociation or at least are changed hydrolytically into hydrosols by long washing. We conclude this, by analogy, from their behavior towards gelatine. Lea found that those adsorbed chlorides "which easily part with one equivalent of chlorine

have a great effect on the sensitiveness of silver chloride to light." This does not conflict with my hypothesis that the hydrolysis of the salts in question has an important bearing on their adsorption because there are always chlorine ions in the oxide hydrosol which act as sol-formers (Jordis).

"My conception of the photohalides as an adsorption compound of silver halide and silver is supported by the fact that silver chloride and silver bromide are colored strongly by colloidal gold and that the gold in these adsorption compounds is no longer soluble in aqua regia. I prepared the colloidal gold for these experiments by reducing auric chloride with dextrine and caustic soda, thereby obtaining a beautiful ruby-red hydrosol. To the hydrosols<sup>1</sup> of silver chloride and silver bromide (each made from 1 gram  $\text{AgNO}_3$ ) were added 100 cc of a 0.1 percent colloidal gold solution. The silver chloride hydrosol, more than the bromide, is colored a beautiful red (with a bluish tinge by reflected light). The mixture of the hydrosols were then precipitated hot with sulphuric acid and washed; the precipitates were grayish-blue in color. To determine whether an actual dyeing had taken place, it was necessary to find a solvent which would dissolve free gold from the mixture, but would not attack the adsorption compound. I could not employ aqua regia of the usual strength because the concentrated hydrochloric acid dissolved the silver halide at once. A brilliant success was obtained with dilute aqua regia (3 vol. conc.  $\text{HCl}$  + 1 vol. conc.  $\text{HNO}_3$  + 6 vol.  $\text{H}_2\text{O}$ ). The gold, precipitated alone from the colloidal gold solution by sulphuric acid, dissolved completely at  $70^\circ$ - $80^\circ$  in the dilute aqua regia, while the adsorption compounds lost only a small portion of the gold, the color changing from a gray-blue to a gray-green which was specially intense in the case of silver chloride and which did not disappear even after long boiling with aqua regia.

"We therefore do not need to accept Carey Lea's view that the adsorption of chlorides by silver chlorides is a proof

<sup>1</sup> These experiments were done in an orange-yellow light.

that the photosalts are compounds of two chlorides of silver not combined in definite proportions. In fact the extraordinary resistance to solvents of the adsorption compounds of the silver halides with colloidal silver and colloidal gold is a strong confirmation of the view which I expressed as a result of my experiments on emulsions, that the latent photographic image is a solid adsorption compound of silver halide with silver."

While the silver photoiodide behaves in many respects like the photobromide and the photochlorides, yet there are some points in which there is a marked difference. I quote, as usual from Lüppo-Cramer:<sup>1</sup>

"Carey Lea cites the easy decomposition of the photoiodide by potassium iodide and the relatively slight resistance to nitric acid as distinctive features of the photoiodide. Lea prepared the photoiodide by treating finely divided silver with a solution of iodine in caustic potash. It can also be prepared by simultaneous precipitation of the hydrosols of AgI and Ag in the same way that I obtained the adsorption compounds of silver with silver bromide and chloride.<sup>2</sup> For most of my experiments I have used the photoiodide prepared in this way. The same reactions are shown by photoiodide prepared according to Carey Lea's method or prepared by treating colloidal silver with an alcoholic solution of iodine. As Lea says, it is necessary to use care in removing the excess of silver from the precipitated photoiodide gel because the photosalt is converted into the normal iodide by too strong an acid. The mixed gel of photoiodide and excess silver is coagulated with sulphuric acid, washed, and then shaken up with water. If small amounts of concentrated acid are added slowly, the change from brown to red or reddish-violet marks the point when all the excess of silver has been dissolved. It is then only necessary to wash the photohalide to obtain it pure. In one of my first experiments I accidentally brought the filter, with some of the photoiodide still on it, into the

<sup>1</sup> Phot. Correspondenz, 44, 538 (1907).

<sup>2</sup> Lüppo-Cramer: Phot. Correspondenz, 44, 289 (1907).

light. To my surprise I saw the red substance bleach completely to pure, yellowish-white silver iodide. I was not able to account for this until I discovered that the merest trace of nitric acid will cause this bleaching in light. Very dilute sulphuric and hydrochloric acids (1 cc concentrated acid per 100 cc H<sub>2</sub>O) will cause the silver adsorbed in the photoiodide to bleach completely if exposed to the sunlight for a few minutes. Hydrogen peroxide and persulphate and even citric acid act in the same way. Soluble iodides, when in concentrated solutions, convert photoiodide into the normal salt in the dark. In sunlight dilute solutions have a surprising effect. Thus a 1 percent potassium iodide solution will bleach the photoiodide in a few minutes under the influence of light while no action is perceptible in the dark even after several days. The photoiodide in the dark is also quite stable with regard to the acids mentioned, though a more concentrated nitric acid will bleach photoiodide in the dark in the course of a few days.

“The easy conversion of the photoiodide into the normal salt by iodides and light is the basis of the phenomenon, studied in 1839 by Lassaigne, since then by Abney and worked out in a practical form in recent years by Hrudnik<sup>1</sup> that silver chloride films, which have blackened in the light, give positives under positives and negatives under negatives if exposed to light after having been dipped in a solution of an iodide. The same result can be obtained with ordinary dry plates which have blackened in the light; an exposure of 20 minutes to diffused daylight under a 10 percent potassium iodide solution will bleach them completely. The photochloride or photobromide formed by the light is converted by the iodide solution into photoiodide, which in the light shows the same tendency to combine with iodine as the synthetic photoiodide. I have often noticed a marked adsorption of the soluble iodide by the photoiodide for the films will bleach in the light even though they may have been washed for a

---

<sup>1</sup> Phot. Correspondenz, 40, 35, 544 (1903).



long time. Lassaigne's reaction takes place especially readily in blue light. Celloidin paper was exposed until a medium tone was obtained, washed, dipped in 5 percent KI, dried superficially with filter paper, and exposed under a color scale. Under the blue there was at once a complete bleaching, while the shade became darker under the other colors. At first it seemed remarkable that what seemed by reflected light to be a complete bleaching under the blue light seemed darker blue when seen by transmitted light. It turned out, however, that this darker color was due to the fact that the iodine, set free by the light, reacted with the starch in the paper to form blue starch iodide. After fixing with hyposulphite which decolorized the starch iodide, the bleaching of the photoiodide could also be seen by transmitted light.

"The bleaching of the photoiodide, by the iodine set free through the decomposition of the iodide by light, takes place equally well with emulsions and with precipitated photoiodide. On the other hand, gelatine and even collodion exercise so strong a protecting influence on the photochemical bleaching by nitric and other acids that the reaction takes place slowly and incompletely, requiring a high concentration of the oxidizing agent.

"When carrying out the Lassaigne reaction it is not necessary to go roundabout through the photochloride or the photobromide. If silver iodide gelatine is blackened under silver nitrate by light, it can be bleached under an iodide solution by light. The following reaction of the silver iodide gelatine is interesting. If a silver iodide gelatine plate is blackened under silver nitrate by light, is washed, is dipped in a 2 percent potassium iodide solution, and is dried in an air current at a moderate temperature, the dark color remains. If the plate is then wetted with water, there is at once a pretty extensive though not complete bleaching. If the plate is left dry the color disappears completely in the course of three or four days."

*Cornell University*

## THE THEORY OF SOLUBILITY

BY D. TYRER

The maximum amount of a substance that a liquid will hold in homogeneous solution at a given temperature, or as it is termed, the solubility of that substance in the given liquid, represents a physical constant which, as yet, it has been found impossible to connect in any consistent manner with any other physical constants or properties of either the solvent or the solute. It is recognized now that this failure to interpret solubility in other terms is due in the case of aqueous solutions, which have received by far the greatest amount of attention, to the complexity of factors coming into play. Before the ideas of hydrates and ions were put forward the dissolution of a salt in water appeared to consist simply of the admixture of the two kinds of molecules, due to an attractive force existing between them, and it was reasonable to expect that the maximum degree of admixture would be found to be related in some way to the properties of the particular solute. Except for a few indefinite generalizations applicable only to closely related substances, the whole accumulated mass of data on the solubilities of substances in water remains an unorganized collection of figures.<sup>1</sup> The failure to find any relationships is generally supposed to be due to the disturbing effects of ionization and solvate formation. Solutions of normal<sup>2</sup> organic solutes in normal unassociated organic solvents do not present such difficulties. Such solutions appear to be simply molecular mixtures of the two substances. For example, there is not the slightest amount of evidence to suppose that a solution of naphthalene in benzene is anything else but a mixture of normal molecules of naphthalene and normal molecules of benzene. Yet in such cases as with

---

<sup>1</sup> Thermodynamic relations are here excepted as not being concerned with the molecular properties of the substances.

<sup>2</sup> Normal substances are defined as those which consist of simple molecules only. Normal solutions contain no ions, associated molecules or solvates.

aqueous solutions the solubility seems to be a quantity quite unrelated to anything else.

A normal solution can only be regarded as a molecular mixture of the two substances just as a mixture of two gases is merely a molecular mixture. It would be possible in fact to pass continuously from a mixture of two gases to a true solution by merely altering the external conditions, in the following manner. Starting with a mixture of two gases A and B, we could by compression and cooling, pass continuously through the critical temperature of the mixture, into the liquid state. Then by further cooling, we could reach a point at which the constituent B say, began to separate out in the solid state. We should then have obtained a saturated solution of the solid solute B in the solvent A. The possibility of such an experiment makes it clear that we cannot draw up any constitutional difference between a normal solution and a mechanical mixture of molecules. But the mixing of two gases cannot in any true sense be regarded as a process of dissolution, nor can we for this reason legitimately describe air as a solution of oxygen in nitrogen. In a solution the mixing of the constituents is brought about by forces of attraction between the molecules of solvent and solute whereas the mixing of two gases under normal conditions consists simply in the mechanical diffusion of the molecules of the one gas among the molecules of the other. This mechanical diffusion is of course due to the rapid and unrestrained motion of the molecules, and must therefore come into play to some extent in the dissolution of a solute. With easily volatile and slightly miscible components, it is probably a considerable factor. For example, mercury is quite insoluble in bromnaphthalene, yet when heated to a temperature of about  $180^{\circ}$  mercury will distil through a supernatant layer of bromnaphthalene just as easily as it does in vacuum. The mercury vapor mixes with the liquid bromnaphthalene just as it does with a gas. It is not a process of true dissolution. The difference between, say, a mixed gas and a true solution may be viewed from another aspect.

Both are molecular mixtures. But in a solution there is a tendency for the molecules of the solute to coalesce and fall out of solution whereas in a mixed gas there is no tendency for either constituent to separate out. But all differences resolve themselves to the fact that in a solution the solute is maintained in the dissolved state by forces of attraction, whereas in a mixed gas under ordinary conditions there is little or no molecular attraction.

In the case of a solid solute and liquid solvent, the tendency of the molecules to diffuse into one another in a manner due solely to the motion of those molecules which have sufficient energy to escape the attraction of the parent substances, is negligibly small. But in the case of a gas and a liquid it is considerable and if the gas is only slightly soluble it is the chief factor involved. Indeed, the validity of Henry's law must depend solely upon this factor. This can be shown in the following manner.

Suppose we have a saturated solution of a slightly soluble gas in contact with excess of gas at constant temperature. Consider unit surface of the liquid. Now if the molecules of gas diffuse freely into and out of the liquid, unrestrained by any forces of attraction, we should have, that the rate of diffusion of gas molecules into the liquid is proportional to the number contained in unit volume of the gas, and the rate of diffusion out again is proportional to the concentration in the liquid. Or, if  $N$  is the number of molecules in unit volume of the gas and  $n$  the number of the dissolved gas molecules in unit volume of the liquid

$$KN = k_1 n$$

where  $K$  and  $k_1$  are constants. This is Henry's law. If on the other hand the passage of the gas into the liquid were due to molecular attractions alone and were therefore a process of true dissolution, the amount of gas dissolved by a liquid would reach a maximum which would be very little changed by the compression of the undissolved gas. With the more soluble gases both processes occur together and Henry's law is therefore violated.

It may be concluded then that the formation of a homogeneous solution of a solute in a solvent is due to two factors.

(1) A process of true dissolution due to molecular forces of attraction.

(2) Simple mechanical diffusion of the molecules due to their rapid motion and not associated with energy changes due to molecular attraction.

Except with gases and easily volatile liquids the second factor is negligibly small.

It may be added that the foregoing remarks are equally applicable to solid solutions. The only real difference between a solid solution and a liquid solution is that in the former the molecules, owing to their closeness of packing, must have comparatively little motion and as a consequence the rate of dissolution is extremely slow.

#### **The Factors Determining the Solubility of a Solute in a Solvent.**

The solubility of a solute in a solvent has been found experimentally to depend upon the following factors:

(1) The nature of the solute and solvent.

(2) The temperature.

It is the object of this paper to draw attention to a hitherto unrecognized factor which plays a very considerable part and renders the term "solubility" as at present understood purely arbitrary and destroys any physical meaning which may have been applied to the term.

It was pointed out above that the chief factor causing dissolution was an attractive force between the molecules of solute and solvent. Since the force of attraction acting on a molecule by a surrounding group of molecules is dependent on the distance of separation of the molecules, it is to be expected that the solubility of a solute will be influenced by the density of the solvent. It was pointed out by the author<sup>1</sup> that the solubility of a solute depends not only upon the temperature and nature of the solvent but also upon the con-

<sup>1</sup> Jour. Chem. Soc., 97, 1778 (1910).

centration of the solvent in the solution, that is, upon the mass of solvent contained in unit volume of the solution. It is in a sense an extension of the law of mass action to solubility. This idea was experimentally established<sup>1</sup> in cases of solutions heated to a temperature above the critical temperature of the saturated solution, when the concentration of the solvent could be varied isothermally. It was observed that the solubility increases with increase of the concentration of the solvent. The recognition of this factor proves that the solubility of a substance in a solvent at a particular temperature, without reference to the density of the solution, is a quantity quite devoid of any theoretical importance and without any definite meaning. It is this indefinite nature of the present conception of solubility that it is the chief object of this paper to emphasize.

The effect of "solvent-concentration" on the solubility of a solute can be best understood by an example. Suppose we take a certain amount of alcohol vapor at 300° under the ordinary atmospheric pressure and bring it in contact with a little sodium iodide. None of the sodium iodide will be observed to dissolve. But if the alcohol vapor be compressed the sodium iodide will begin to be appreciably soluble and when, for example, the solvent concentration is such that 1 cc contains 0.3 gram of alcohol the solubility of the sodium iodide will be approximately 4.8 percent. The solubility continues to increase with further compression. Numerous other cases in which the solubility of a solute has been directly observed to increase as the concentration of the solvent increases might be mentioned but the reader is referred to the author's paper quoted above. The insolubility of, say, a salt in steam and its solubility in water at 100° is a case of the effect of solvent-concentration. If a solvent be diluted with a liquid in which a given solute is insoluble the solubility in the solvent is always diminished.<sup>2</sup>

<sup>1</sup> Tyrer: *Jour. Chem. Soc.*, 97, 621 (1910).

<sup>2</sup> *Ibid.*, 97, 1778 (1910).

The meaning and importance of solvent-concentration as a factor determining solubility can be best shown graphically.

The construction of the accompanying figure, Fig. 1, although it represents a purely imaginary case, is based on the results of the author's measurements of solubilities of salts in solvents in the neighborhood of the critical temperature.

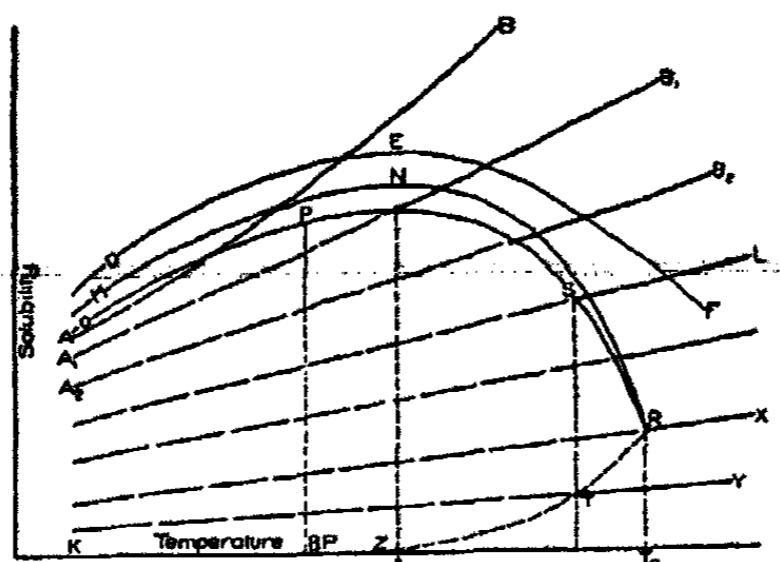

Fig. 1

The curves  $AB$ ,  $A_1B_1$ ,  $A_2B_2$ , . . . . . etc., represent solubility curves for constant concentrations of the solvent. For example, if we confine the solution in a closed space so that its volume does not change on heating, then the solubility-temperature curve will be represented by a line similar to the lines  $AB$ ,  $A_1B_1$ , etc. That the solubility of a normal solute in a normal solvent at constant solvent-concentration, increases with the temperature must follow from the fact that the solubility, under ordinary conditions, increases with the temperature although the concentration of the solvent in the solution decreases. The higher lines in the diagram refer to greater solvent-concentrations. The curve  $OPSR$  represents the ordinary solubility curve, the solution being heated under constant atmospheric pressure to the boiling point and from the boiling point to the critical temperature under its own vapor pressure.

When a saturated solution is heated in contact with excess of solute, the solvent-concentration decreases. At tem-

peratures below the boiling point the rate of the decrease is comparatively small but at higher temperatures it becomes greater, and just before the critical temperature of the saturated solution is reached, it becomes very rapid. This causes the solubility near the critical point, to fall rapidly. With solutes which are not appreciably volatile before the critical temperature is reached (salts for example) it may be taken as highly probable that the solubility under a pressure equal to the vapor pressure of the saturated solution, decreases greatly before the critical temperature is reached. With fairly volatile solutes, however, such as organic substances, the solubility will always increase with rise of temperature and will eventually, either before or after the critical temperature of the solution has been reached, become infinitely great. The diagram represents a case of a non-volatile solute.

Suppose we have a sealed glass tube about half filled with a solvent and containing also excess of a non-volatile solute. As the tube and contents are slowly heated more and more of the solute will dissolve, until a point of maximum solubility is reached at, say, the temperature  $t$ . Further heating will cause some of the dissolved solute to be precipitated. If now the tube contains neither too much nor too little liquid, the solution will pass continuously through the critical temperature  $T_c$  at which point there is a break in the solubility curve. With further heating the solubility in the one homogeneous phase passes along the curve  $RX$ . If the tube contains a relatively small amount of liquid, then before the critical temperature is reached it evaporates completely, say, at the point  $S$  on the curve. The solubility, now in the homogeneous vapor phase, will pass along the curve  $TY$ . If, on the other hand, the tube contains a relatively large amount of liquid, then at some point on the curve, say, at  $S$ , the liquid, owing to its expansion, will just completely fill the tube and the solubility will then pass along the curve  $SL$ , increasing with rise of temperature.

As has been already mentioned the ordinary solubility curve as far as the boiling point refers to a constant pressure



of one atmosphere. If the solution is compressed the solvent-concentration increases and the solubility therefore increases. We may have therefore another series of curves which represent the solubility at different temperatures, each at a constant external pressure. For example, suppose a constant pressure is maintained on the solution equal to the critical pressure of the saturated solution, then we should find the solubility represented by a higher curve MNR. Under a constant pressure of, say, 1000 atmospheres we should obtain another curve DEF.

It will be clearly seen that the ordinary solubility curve is quite arbitrary and meaningless. It represents neither the solubility at constant solvent-concentration nor at constant pressure except for the portion below the boiling point.

It may be mentioned that the region OPRZK in the diagram is not practically attainable. The curves in the region of the critical temperature have been experimentally obtained in two cases, though they were not strictly normal solutions, because solvates were probably formed in solution. But still the formation of solvates would not alter the general form of the solubility diagram but would only change the slope of the curves. The diagram is typical and is a complete solubility diagram. The curves for constant solvent-concentrations may be termed solubility isochors and those at constant pressure solubility isobars.

The solubility of any solute in a solvent is completely determined by two variables, temperature and solvent-concentration

$$S = \varphi(T, C)$$

where  $S$  is solubility,  $T$  is the temperature and  $C$  the concentration of the solvent.  $C$  could, it may be mentioned, be replaced by a function of the density of the solution, but the function here adopted is the more rational. To completely determine this equation it is necessary to find experimentally the relationship between the solvent-concentration and the solubility when the temperature is maintained constant and then to determine the solubility as the temperature varies.

Suppose we have a particle of a solute surrounded by its saturated solution in a particular solvent. On account of the attractive forces of the surrounding solvent molecules there will be a tendency for the molecules of solute on the surface of the particle to dissociate themselves from the rest of the solute and to pass into solution. But in opposition to this dissolving force and in equilibrium with it, is a molecular force of attraction acting between the molecules of solute on the surface of the particle and those in the interior of the particle. Although a free interchange of solute molecules must go on between the solution and the undissolved solute we can quite legitimately imagine there to be a state of static equilibrium, the molecules on the surface of the particle being just prevented from dissolving by the inner attractive force of the other molecules of the solute. For a particle whose diameter is greater than the diameter of the sphere of attractive influence of a molecule, the latter force will be a function of the density of the solute. If we suppose molecular attraction to be independent of the temperature and if the force between two molecules, the distance between the centers of which is  $S$ , can be represented by

$$\frac{K}{S^n}$$

where  $K^1$  is a constant<sup>1</sup> dependent on the nature of the substance and  $n$  is a small numeral constant for all substances, then we can represent the inner force of attraction acting on a molecule at the surface of an undissolved particle of solute by

$$\frac{C}{v^m}$$

where  $C$  is a constant, and  $v$  is the specific volume of the solute. The dissolving force or the force which causes the molecules of solute to pass into solution is made up of two

---

<sup>1</sup> It would be too long to give a proof here of this term, the reader may be referred for a treatment of molecular attraction to the papers by J. E. Mills: *Jour. Phys. Chem.*, 6, 209 (1902); 8, 383 (1904); 9, 402 (1905); 10, 1 (1906).

parts: (1) The attraction of the molecules of solvent on the molecules of the solute; (2) the attraction of the molecules of solute already dissolved. The first of these quantities will depend upon the total volume occupied by the solution containing a constant amount of the solvent, and it may be expressed as

$$\frac{C_1}{V^{n_1}}$$

$V$  being the total volume of the solution. The second quantity will depend upon the concentration of the molecules of the solute in the solution and may be written

$$C_2 \left( \frac{N}{V} \right)^{n_2}$$

where  $N$  is the number of molecules dissolved.

We must have then according to our principle the equation

$$\frac{C}{v^{n_1}} = \frac{C_1}{V^{n_1}} + \frac{C_2}{V^{n_1}} \left( \frac{S}{M} \right)^{n_2}$$

where  $S$  is the solubility and  $M$  the molecular weight of the solute.

This gives

$$a \left( \frac{V}{v} \right)^{n_1} - b = S^{n_2}$$

where for a given solute and solvent  $a$ ,  $b$ , and  $n$  are constants. But  $V$  is a function of the specific volume of the solvent and of the solubility. Now it has been shown experimentally that the volume of a solute in solution, is, in normal cases, approximately equal to the volume occupied by the pure liquefied solute at the same temperature.<sup>1</sup>

We may write then

$$V = Wv_1 + Sv_2$$

where  $v_1$  is the specific volume of the pure solvent,  $v_2$  the specific volume of the solute in solution and  $S$  the amount of solute in  $W$  parts of the solvent.  $S$  is then, the solubility when we put  $W = 100$ .

<sup>1</sup> See Tyrer: Jour. Chem. Soc., 97, 2620 (1910); 99, 871 (1911).

Our equation of equilibrium then becomes

$$a \left( \frac{100v + Sv_s}{v} \right)^{n_1} - S^{n_1} = b$$

In this equation  $a$  and  $b$  are constants,  $s$  the solubility,  $v_s$  and  $v$  the specific volumes of the pure solvent and pure solute respectively and  $v_s$  the specific solution volume of the solute.

It cannot be tested quantitatively, as we do not know  $n_1$  and in any case experimental data are much too incomplete. It may, however, be applied qualitatively.

Take as the first case a gaseous solute and liquid solvent. If the solubility is small we can neglect the term  $Sv_s$ .

With rise of temperature  $v$  increases at a greater rate than  $v_s$  and hence the solubility must diminish. Increase of pressure for similar reasons should cause the solubility to increase. With a liquid solute the solubility may either increase or decrease with the temperature. As a matter of fact practically all really normal liquids are miscible in all proportions. With a solid solute since  $v_s$  increases at a greater rate than  $v$ , rise of temperature should always cause (in normal cases of course) the solubility to increase. Until experimental data are available nothing more can be done to test the validity of the above equation.

A few remarks may be made here regarding infinite solubility. With a solid solute and a liquid solvent it is obvious on account of their physical difference that a solid can never become infinitely soluble at a temperature below its ordinary melting point. When two normal liquids are mixed very little heating effect is produced. This appears to be quite a general rule. Moreover very little change in volume occurs. This clearly means that little or no work is done in the dissolution of a normal liquid solute in a normal liquid solvent, and from this we should expect that normal liquids are miscible in all proportions. And I do not know of a single case in which two normal liquids are only partially miscible. If this rule is quite general then it follows, that with normal solid solutes, the solubility in a normal solvent

increases with the temperature and becomes infinitely soluble at its melting point. Sufficient experimental data exist in a few cases to test the accuracy of this suggestion. In the following table are given the temperatures at which the specified solutes become infinitely soluble. These temperatures have been found by extrapolating the solubility curves, the solubility being expressed in parts per 100 of saturated solution. The solubility data were taken from Seidell's dictionary of solubilities. In the last column are given the melting points of the solutes.

Solute	Solvent	Temperature of infinite solubility	Melting point of solute
Naphthalene	Carbon tetrachloride	80°	80°
	Carbon bisulphide	78°.5	
	Benzene	79°.5	
	Chlorobenzene	79°.5	
	Hexane	79°	
Triphenylmethane	Benzene	94°	92°
	Carbon bisulphide	94°	
	Hexane	92°	
	Chloroform	95°	
	Pyridine	92°.5	
	Pyrrol	93°.5	
	Thiophen	93°.5	
<i>m</i> -Dinitrobenzene	Benzene	92°	89°
	Chloroform	88°	
<i>p</i> -Dibrombenzene	Ether	84°	89°
	Carbon bisulphide	84°	
	Benzene	84°.5	
	Brombenzene	88°	
Anthraquinone	Ether	275° (experimental)	285°

Considering the approximate character of the figures there is a fairly close agreement between the temperatures of infinite solubility and the melting points. In the case of dibrombenzene the temperatures of infinite solubility is somewhat lower than the melting point. This can only be due to errors for although a solute does not necessarily become

infinitely soluble at the melting point it cannot clearly attain this point below the melting point.

Given two normal liquids, some condition relative to their properties must be determinable upon which depends the possibility of their mixing in all proportions. It can be shown on the basis of molecular attraction that when a liquid solute is added gradually to a liquid solvent, both being normal, that the total force, in virtue of which the solute tends to dissolve, first decreases, reaches a minimum and then increases. If the total force acting against the dissolution tendency be less than this minimum value, the two liquids will be miscible in all proportions.

It has already been shown that the dissolution of a particle of a solute in a liquid is due to (1) the attraction exercised by the molecules of the solvent (2) the attraction exercised by the molecules of solute already in solution. The total force of attraction inducing dissolution may be written

$$\frac{C_1}{V^{n_1}} + \frac{C_2 S^{n_1}}{V^{n_1}}$$

where  $C_1$  and  $C_2$  are constants,  $v$  is the total volume of the solution containing say 1 gram of solvent and  $S$  is the mass of solute in the solution. The force of attraction acting between the molecules of the undissolved solute and restraining the dissolution may be expressed

$$\frac{C}{v^{n_1}}$$

where  $C$  is a constant and  $v$  is the specific volume of the solute. If the solution is unsaturated then

$$\frac{C_1}{V^{n_1}} + \frac{C_2 S^{n_1}}{V^{n_1}} > \frac{C}{v^{n_1}}$$

The problem is to determine how the expression on the left varies as the solubility increases.

Now since in a normal solution of two liquids no change in volume occurs when they are mixed we may write

$$V = v_1 + Sv_2$$

where  $v_l$  is the volume of the 1 gram of the solvent and  $v_s$  the specific volume of the solute.

Therefore, the above expression becomes

$$\frac{C_1}{(v_l + Sv_s)^{n_1}} + \frac{C_2 S^n}{(v_l + Sv_s)^{n_1}} > \frac{C}{v_s^{n_1}}$$

It can readily be shown by differentiation that the expression on the left is a minimum when

$$S = \left( \frac{C_1}{C_2} \cdot \frac{v_s}{v_l} \right)^{\frac{1}{n_1-1}}$$

Therefore, the required condition for complete miscibility or infinite solubility is that

$$\frac{C_1}{\left\{ v_l + v_s \left( \frac{C_1}{C_2} \cdot \frac{v_s}{v_l} \right)^{\frac{1}{n_1-1}} \right\}^{n_1}} + \frac{C_2 \left( \frac{C_1}{C_2} \cdot \frac{v_s}{v_l} \right)^{\frac{n}{n_1-1}}}{\left\{ v_l + v_s \left( \frac{C_1}{C_2} \cdot \frac{v_s}{v_l} \right)^{\frac{1}{n_1-1}} \right\}^{n_1}} \geq \frac{C}{v_s^{n_1}}$$

It would be impossible to deal quantitatively with this equation without a knowledge of the law of molecular attraction. But it suffices to show the possibility of treating the phenomenon of solubility from a mathematical basis.

#### On the Relative Solvent Powers of Different Liquids for a Given Solute

The solubility of a solute in a solvent depends of course on the nature of both substances, but by making the solute constant we cause it to depend solely upon the solvent. We thus obtain a conception of relative solvent power. The solvent power of a liquid is measurable by the solubility of the particular solute. But the solubility depends upon the two conditions; temperature and solvent-concentration. We may define then the solvent power of a liquid towards a particular solute at a given temperature, as the solubility of the solute in the solvent at unit solvent-concentration. And the molecular solvent power may be defined as the solubility when unit volume contains 1 gram molecule of the solvent.

As temperature rises the solvent power of a liquid for a particular solute (normal cases only are considered) in-

creases. Eventually the solute becomes infinitely soluble, when the solvent power may be regarded as becoming infinitely great.

The liquid which will dissolve most of the given solute has not necessarily the greatest solvent power, for the solvent concentration must also be taken into account in making comparisons.

For comparatively small differences in the concentration of a solvent we may regard the solubility as a linear function of the solvent-concentration and we can thus obtain an approximate idea of the relative solvent powers of various normal liquids for a given solute. In the following table are given the solvent powers of four liquids for naphthalene at 20° calculated in this way:

Solvent	Grams of naphthalene dissolved by 1 gram molecule of solvent	Molecular concentration of solvent in saturated solution	Molecular solvent power at a constant molecular solvent concentration of 0.00854
Chloroform	37.9	0.00854	37.9
Toluene	25.7	0.00724	30.4
Benzene	43.9	0.00762	49.2
Hexane	14	0.00712	16.8

Benzene would appear to be the best solvent (in the present sense of the word) for naphthalene and hexane the worst of the four.

It would be very interesting to determine in this manner the relative solvent powers of the above and other liquids for other solutes and to see whether or not they fall into the same order, and it would also be interesting to determine whether the order of arrangement was affected by temperature, but unfortunately insufficient experimental data are available.

The advancement and general recognition of the hydrate theory and of the theories of dissociation and molecular association have rendered the further study of solubilities in associated solvents like water and the alcohols, quite useless



from the point of view of the theory of solubility. In this sense it is unfortunate that so much work should have been done on aqueous solutions in which a hopeless complication of factors comes into play, and so little done with unassociated organic substances which present cases far simpler in character.

There is one question, however, which must precede a quantitative study of solubility and that is the determination of the law governing molecular attraction, and until this problem is solved there can be little hope of completely understanding the process of dissolution. And this is self-evident when one considers that the dissolution of a solute is caused by molecular attraction, and that the solute is held in solution by the same forces. Solubility is, in fact, but a problem of molecular attraction.

#### Addendum

Since writing the above the author's attention has been brought to a paper by Hardman and Partington<sup>1</sup> in which some views of the author on the subject matter of the present paper, are criticised. Objection is raised to the conception of the solvent-concentration as a factor influencing solubility. They consider the simple equation

$$S = \phi(T)$$

where  $S$  is the solubility and  $T$  the temperature, to be sufficient and to include all possible factors. But it cannot clearly be true because when the temperature is constant the solubility may still vary with the density of solution. This variation is moreover experimental and quite free from any hypothetical assumptions. It might also be urged that the variation of solubility when the solvent density is changed could be interpreted in terms of the external pressure. But this would be unsatisfactory because a liquid and saturated vapour both are under the same external pressure yet do not dissolve the same amounts of a common solute. We could however, write the solubility at constant temperature, as a function of the

<sup>1</sup> Jour. Chem. Soc., 99, 1769 (1911).

density of the saturated vapour but it is more rational to refer it to the concentration of the solvent, since it is chiefly a property of the solvent.

A few remarks may be made here in regard to equations representing the variation of solubility and variation of the temperature. It is obvious from the foregoing that no such equation is complete which does not take account either of the density of the solution or the concentration of the solvent in the solution. R. Hardman and Partington have reduced the following equation

$$\log S = A - \frac{B}{T} - C \log T$$

where  $S$  is the solubility  $A$ ,  $B$  and  $C$  are constants. Several of the assumptions however on which this equation is based, are quite erroneous. For example it was assumed that the specific heat of a liquid is constant over a moderate range of temperature. In the case of benzene which was the solvent used in the cases employed to test the equation, the specific heat varies about 12 percent over a range of about 70 degrees. The equation however holds fairly closely. But thus it must clearly do on account of its general character. It contains three constants and is similar in character to the equation

$$S = A + BT + CT^2$$

which holds equally well. The most elementary study of solubility curves, will show the impossibility of representing the relation between solubility and temperature by a general equation of a simple character. There is probably no solubility equation containing less than three constants all of which depend on the nature of the solution and an equation with three unknown constants is of little practical value.

*The Chemistry Department,  
The University,  
Manchester*

## NEW BOOKS

**Handbuch der Spectroscopie.** By H. Kayser. *Vierter Band.* 18 × 25 cm; pp. xix + 1248. Leipzig: S. Hirzel, 1908. Price: paper, 72 marks; linen, 76 marks.—Though it is probably a grief to the author and the publisher that this book was not reviewed earlier, it is an ill wind that blows nobody good, and the reviewer has appreciated the volume much more than if he had read it when it first appeared.

The first three chapters give an account of the absorption spectra of the natural coloring matters found in plants, man, and other animals. The fourth chapter treats of dispersion, the fifth of phosphorescence, and the last of fluorescence. While all are interesting, the chapter on phosphorescence will probably appeal most to the chemist and the author has certainly given a remarkably good exposition of our knowledge of phosphorescence.

Kayser's own definition p. 599, of phosphorescence is too narrow. "I understand by phosphorescence the phenomenon of a substance, in response to some excitation, emitting light for a finite time after the excitation has ceased. The light must contain some wave-lengths having a greater intensity than those emitted by a black body at the same temperature, and so visible chemical change shall occur." Since all phosphorescence is unquestionably due to chemical action, it is merely a question of the conditions of excitation whether any visible chemical change takes place or not, and consequently the last clause of the definition is superfluous. The faulty definition has not affected the presentation of the subject.

Of the very early work, some of the interesting things are Wedgwood's experiments on the action of heat on powders, p. 623; Davy's experiments on phosphorescence produced by friction, p. 627; Dessaigne's experiments on phosphorescence, p. 630; the fact that diamonds emit the same light when rubbed as when exposed to sunlight, p. 613.

When we come to the later work, the important figures are Wiedemann and Schmidt, and Lenard and Klatt. The conversion of fluorescence into phosphorescence by the simple expedient of adding gelatine, p. 653, is of great importance theoretically and should be taken up again as a general problem in colloid chemistry. While the evidence is now fairly conclusive that pure sulphides of the alkaline earths do not phosphoresce, pp. 652, 693, 742, there is nothing in the book to show whether they glow while the light is on and the question of purity does not come up under fluorescence.

While Kayser recognizes, p. 752, that the existence of so-called solid solutions is essential in the case of the alkaline earth sulphides and is probably necessary in the case of zinc sulphide and many other substances, he is not prepared to admit such a hypothesis for colorless diamonds, uranium salts, platinum double cyanides, or many organic substances.

Under fluorescence, a great deal of space is given, very properly, to an account of Wood's work. On p. 938 the author says that he has given Wood's experimental results at great length because they seemed to him of the utmost importance not only for the special field of fluorescence but for the whole subject

of emission. On p. 918 he speaks of the pleasure it gives him to note the way in which Wood has perfected methods and apparatus.

In view of the many bright lines in the spark spectrum, one does not see any legitimate reason for postulating that in the fluorescence spectrum, each band corresponds to a different substance, and it is gratifying to see the author, p. 1035, taking a stand against such a hypothesis.

The volume is a treasure-house of facts and is invaluable to everybody interested in phosphorescence or fluorescence. *Wilder D. Bancroft*

**Ostwald-Luther's Physiko-chemische Messungen.** Edited by R. Luther and K. Drucker. Dritte Auflage. 16 X 24 cm; pp. xvi + 573. Leipzig: Wilhelm Engelmann, 1910. Price: bound, 13 marks.—This book is the standard and is likely to remain so for a long time. Consequently the appearance of a new edition is always to be welcomed. The official editor is now Dr. Drucker but the work has been done under Luther's direction and the change of editor is merely what is to be expected as time goes on, and duties change and increase. The chapters on calculation, measurement of length, weighing, measurement of temperature, and glass-blowing were written by Luther. Those on calorimetry and measurement of high and low temperature were written by Wigand, while Wigand and Goldberg worked together on optics. Luther and Marc wrote the chapters on chemical dynamics and on determination of constitution while the chapters on thermostats, on electrical measurements in general, and on measurements of electromotive force are the joint work of Luther and Drucker. The remaining chapters are the work of the new editor who is to be congratulated on the success of the new edition. We may also congratulate the retiring editor because he is the one who is responsible for the general plan of the book as well as for a large number of the details. The new edition is quite a distinct book from the previous ones. So far as the reviewer can judge it is also a better book. *Wilder D. Bancroft*

**Traité de Physique.** By O. D. Chvolson. Ouvrage traduit sur les Éditions russe et allemande par E. Davaux. Édition revue et considérablement augmentée par l'Auteur, suivie de Notes sur la Physique théorique par E. Cosserat et F. Cosserat. Tome premier, troisième fascicule. 16 X 25 cm; pp. vii + 872. Paris: A. Hermann, 1907. Price: paper, 12 francs.—This volume deals with liquids and solids. Under the first head the chapters are: fundamental properties and constitution of liquids; density of liquids; compressibility of liquids; surface tension of liquids; phenomena of adhesion and capillarity; solutions of solids and liquids; diffusion and osmose; viscosity of liquids; movement of liquids; colloidal state. Under solids the chapters are: matter in the solid state; density of solids; deformation of solids; friction and shock.

When discussing surface tension, p. 595, the author says: "There is not yet any good explanation for the existence of a more dense surface film on liquids. The presence in this film of forces directed toward the interior of the liquid does not explain the condensation of this film. These forces must produce a pressure which, in accordance with the fundamental laws of hydrostatics, is transmitted throughout the liquid in all directions and must give rise to the same condensation throughout the whole mass. In fact some arguments lead to the

contrary conclusion, that the density of the surface film would be less than that of the rest of the liquid, at least in the direction normal to the surface. The different attempts at accounting for the particular properties of the surface film on liquids tend to show that in this film the molecules must be closer together parallel to the surface; but these proofs are not very convincing. We know nothing of the causes for the forces of cohesion nor do we know the laws according to which they act. We do not know how the mean distance between the molecules depends on these forces and on the nature and velocity of the molecules. It is therefore not surprising that we are not able to form a satisfactory picture of the distribution of the molecules in the surface film of a liquid. The conception of surface tension in liquids rests entirely on the analogy between the properties of the surface film and those of an elastic membrane; it is completely lacking in a solid scientific basis. The conception is a very useful one, however, because it enables us to group under one head a number of apparently different phenomena. ~~It helps us to understand and to describe the facts.~~ Whether surface tension really exists may therefore be left as an open question."

On p. 622 the author describes an interesting experiment, due to Jamin, in which one measures the forces with which water is adsorbed by chalk. The measurement is purely qualitative; but it would apparently be worth while if somebody should convert it into a quantitative method.

On p. 732, when speaking of colloids, the author takes the only rational ground, namely, that freezing-point determinations give absolutely no information as to the molecular weights of colloids. "These measurements are only applicable to homogeneous media, to true solutions; and one is really studying the intergranular liquid and not the suspension as a whole." On the other hand, the author says, p. 738, that the stability of a colloidal solution depends on three factors: surface tension, the electric charge, and the viscosity of the medium. In the cases of an emulsion we know from Pickering's work, that the presence of a viscous surface film is a more important factor than any of the three cited by the author.

When finished Chwolson's *Physics* is going to be a more remarkable work than Wiedemann's *Elektricität* because its field is broader. *Wilder D. Bancroft*

**Ueber Katalyse.** By Wilhelm Ostwald. 15 × 22 cm; 39 pp. Leipzig: Akademische Verlagsgesellschaft, 1911. Price: 1.50 marks.—This is the second edition of Ostwald's address when receiving the Nobel prize. The fundamental point in which Ostwald says that he differs from all his predecessors is that he lays stress on the fact that a catalytic agent merely accelerates a reaction which is actually taking place. It is doubtful whether Ostwald's claim to fame will rest on this point. Quite regardless of whether the generalization is right or not, it is certainly doing more harm than good now. The physical chemists are very much handicapped because they do not realize that a catalytic agent may produce an actual displacement of equilibrium, though perhaps not a theoretical one. Ostwald's work on catalysis has been first-class and has been worthy of the Nobel prize; but the important part of it all has been the quantitative work. *Wilder D. Bancroft*

## THE PHOTOGRAPHIC PLATE VIII

BY WILDER D. BANCROFT

### The Latent Image. Part IV

According to Lüppo-Cramer<sup>1</sup> "the formation of the photohalides depends very largely on the physical state, a fact which has usually been overlooked by those studying the problem of the latent image or of the subhalides. This in itself is an argument in favor of the photohalides being adsorption compounds. When testing some of the methods of preparation recommended by Carey Lea, I made some experiments which illustrate this point.

"Colloidal silver was made by reduction with dextrine according to Carey Lea's directions, was precipitated with dilute sulphuric acid, and was washed thoroughly with dilute solutions (1-10 percent) of potassium bromide, whereupon the fine suspension underwent a remarkable change. The suspension flocculates, changes color, and can be washed for a time very easily. After the washing has been carried on for a good while, the black silver peptonizes, just as the gels of silver bromide do, and part of the silver goes into colloidal solution. If one adds nitric acid to the portion of the silver gel which has not been peptonized, the pure silver is dissolved and there remains quite an amount of a beautifully colored, violet photobromide. The bromide must therefore have been adsorbed with great readiness by the silver gel. It is immaterial whether the silver gel still contains traces of the acid with which it was precipitated, whether it is neutral, or whether the mixture is strongly alkaline. On the other hand, if one uses a concentrated bromide solution (50 percent KBr), there is no adsorption at all. When bromide of this concentration is added, the silver settles much more slowly, no peptonization takes place during the washing, and there

<sup>1</sup> Phot. Correspondenz, 45, 297, 352 (1908).

is no formation of photobromide though traces of uncolored silver bromide may be formed.

"If the treatment of the silver with the bromide solution gave rise solely to a chemical reaction such as the bromination of the silver, it is improbable that it would take place in very dilute solutions (as low as 0.1 percent final concentration of potassium bromide is enough) and especially in alkaline solutions; but if it did, the action ought to be more energetic in the more concentrated solutions and should not come completely to a standstill. When silver gel is treated in a similar way with chloride, the action varies in a like manner with the concentration of the chloride.

"We can account for the apparent paradox, that increasing the concentration prevents the reaction between the silver gel and the halide, by assuming that the high concentration of the electrolyte changes the structure of the silver gel in such a way that its power to adsorb substances is either lost or is decreased very much. The accuracy of this hypothesis is proved by the later experiments.

"For comparison with the colloidal gel of silver, a form of the metal was prepared which seemed to be completely lacking in the characteristic property of the gels. To 50 cc of a 10 percent silver nitrate solution were added, first the amount of ammonia (sp. gr. 0.91) necessary to form ammoniacal silver oxide, and then 20 cc of a 40 percent formaldehyde solution. The silver came down in part as a mirror but chiefly as a light gray precipitate. The mixture was boiled for a few minutes and the silver was then washed thoroughly. When this light gray silver was treated with bromide solution as before, no adsorption of the halide could be detected; there was no adsorption even when the silver was digested for a long time with concentrated potassium bromide solution. It is the gel structure of the black silver which determines the adsorption and not, as some might assume, the presence of dextrine as a protecting colloid; because a gel which has been purified from dextrine, adsorbs halides and forms photobromide. It is also not necessary

to bring the silver in gel form in contact with the halides. Direct precipitation of the solution of silver with dilute bromide solution gives the same results. For these experiments colloidal silver solution was used which was prepared by Carey Lea's ferrous citrate method as well as the one obtained by reduction with dextrine. This latter was freed from the large excess of alkali by precipitation with alcohol but the solution was still strongly alkaline. The precipitation of these solutions with dilute potassium bromide solutions yielded first a black, muddy silver which peptonized after long washing and which left a violet photobromide when treated with nitric acid. If the precipitation of the solution was caused by large amounts of concentrated bromide solution, there was neither peptonization nor formation of photobromide.

"As might be expected, the method of precipitation and the chemical nature of the reducing agent only affect indirectly the tendency of the silver to form photobromide. Even the silver gel, which is protected by dextrine loses its power to form photobromide through adsorption of bromide, if the black silver is converted into the light gray form by continued boiling with dilute sulphuric acid. If silver nitrate is reduced with formaldehyde and sodium carbonate (equal volumes 10 percent  $\text{AgNO}_3$ , 10 percent  $\text{Na}_2\text{CO}_3$  and 40 percent formaldehyde), the silver carbonate, which first precipitates, is reduced to black silver which can be washed out. If the mixture is heated, the gray form of silver is soon produced. The black form, when thus obtained, shows the usual adsorption of halide while the gray form does not do this. The reduction of silver solution with oxalate yields a silver, which at first is pure black, and gives the characteristic reactions of the black silver. When heated, there is a rapid change to gray silver and a disappearance of adsorbing power.

"It is thus clear that the formation of the photohalides occurs when colloidal silver, as solution or gel, adsorbs halides and is then treated with nitric acid. This enables us to account for many of Carey Lea's methods of preparing photo-



halides. In all cases the important thing is that the silver should be formed as much as possible in a colloidal state. In such cases the presence of a small amount of any halide during or after the reduction is sufficient to cause the formation of an adsorption compound. When most of the silver is dissolving, such an adsorbed neutral salt has an extraordinary tendency to cause the newly formed silver bromide to react with a portion of the silver, producing the same adsorption compound, which is obtained when a silver bromide gel reacts with colloidal silver. I have described<sup>1</sup> similar phenomena when studying the adsorption of hyposulphite, etc., by silver gel. We are however quite at a loss to understand the mechanism of this kind of combination."

"In any discussion of the formation of the photohalides, one must be very careful when considering the reduction of the silver halides. In a paper on 'The Formation of Colloid Silver by the Reduction of Silver Bromide' I have<sup>1</sup> myself interpreted wrongly the formation of photobromide. I had reduced silver bromide with the ordinary oxalate developer, had washed out the reduction product with dilute sulphuric acid to remove basic ferric salt, and had obtained photobromide by treating with nitric acid. When I repeated the experiment some time later, I obtained mere traces of photobromide instead of 4-6 percent as before. I was forced to assume some unconscious, slight change in the conditions, a thing which may readily occur in such delicate work because one does not always make a note of all apparently unimportant details. It was a long time before I discovered that it was of fundamental importance to acidify with sulphuric acid immediately after reduction. If we assume that the formation of the photobromide takes place at the moment of reduction, it is quite unintelligible why it should be necessary to acidify at once and not after washing as was the case in my later experiments. After much trouble I discovered that the photobromide was formed as a sec-

<sup>1</sup> Lüppo-Cramer: *Phot. Correspondenz*, 45, 159 (1908).

<sup>2</sup> *Ibid.*, 45, 570 (1907).

ondary product due to the combined action of the iron salt and the sulphuric acid on the reduction product. If silver bromide is reduced by ferrous oxalate and if the product is washed thoroughly with pure water, no photobromide is formed on treatment with nitric acid. If the reduced silver is treated with a mixture of potassium bromide, potassium ferric oxalate and dilute sulphuric acid, one notices at once that the silver becomes darker. When the silver is dissolved in nitric acid, quite a lot of bluish violet photobromide is left behind. Systematic experiments showed that all three substances are essential to the partial conversion into photobromide, of silver reduced by ferrous oxalate. Evidently the ferric salt and the bromide yield free bromine which forms photobromide. The neutral potassium ferric oxalate will not do this because the ferric oxalate complex is so stable that no ferric ions<sup>1</sup> are present until the acidification with sulphuric acid.

"This secondary formation of the photohalides shows in a still more interesting way in a method which Carey Lea says is the best for preparing photochloride and which apparently involves the primary formation of photohalides as intermediate products in the reduction of the normal halides. Carey Lea reduced a solution of silver chloride in ammonia. As I have previously mentioned,<sup>2</sup> the photochloride thus obtained is not attacked at all by concentrated nitric acid. In view of the great reducing power of an alkaline ferrous oxide solution, one would suppose that the silver chloride would be reduced chiefly to silver. This is not the case, for when the thoroughly washed photochloride was dissolved in hyposulphite, there was so little silver left that there was only a dark clouding and no actual precipitate.

"This made me suspect that the reduction of ammoniacal silver chloride takes place in a way similar to the reduction of silver bromide by ferrous oxalate. To test this, the reduced silver chloride was washed until the wash-water gave

<sup>1</sup> Cf. Abegg: *Archiv. wiss. Photographie*, 2, 77.

<sup>2</sup> Lüppo-Cramer: *Phot. Correspondenz*, 44, 287 (1907).

no test for chloride. The amount of chloride in the washwaters showed that quite a large amount of silver chloride must have been reduced, an amount out of all proportion to the small quantity of silver adsorbed in the photochloride of the previous experiment. If the washed mixture of reduced silver and ferric oxide is treated with sulphuric acid, brown silver is formed which dissolves, with the exception of a small amount of photochloride, in more sulphuric acid owing to the presence of ferric salts. This experiment proves conclusively that silver chloride is reduced completely to silver but that the silver gel reacts with the ferric ions and the halide to form almost the original amount of silver chloride when the mixture is acidified.

"A similar state of things occurs in one of the methods for making photobromide as given by Carey Lea. The secondary formation is even clearer here. Since silver bromide is only slightly soluble in ammonia, only small amounts of photobromide were formed when an ammoniacal silver bromide solution was reduced. Carey Lea therefore adopted the following method. He reduced a solution of 6 grams  $\text{AgNO}_3$  in 200 cc  $\text{H}_2\text{O}$ , to which enough ammonia was added to make the precipitate redissolve, with a solution of 12 grams ferrous sulphate in 200 cc water. He added 4 grams  $\text{NaOH}$ , then 5 grams  $\text{KBr}$ , and thereupon acidified with sulphuric acid, thus obtaining the photosalt. The silver precipitates as colloidal silver. The ferric salt and the bromide reacted with the silver when the solution was acidified, forming a silver bromide, which adsorbed a small amount of silver. Since Carey Lea used less bromide than was equivalent to the silver, there was some silver left over, which dissolved in nitric acid. The yield of sub-bromide was small in this experiment, about 7.98 percent. If the photobromide was treated with hyposulphite, there was only a dark clouding, indicating a very small amount of silver."

"Photohalides appear never to be formed by direct reduction of the normal halides. Since the former are more

easily reduced<sup>1</sup> than the latter, it is not surprising that silver bromide is reduced completely to silver when treated with a powerful reducing agent such as a developer, and that no intermediate product can be detected. We do not get a photobromide, however, with weaker reducing agents, not even with ferrous citrate and tartrate, which reduce a soluble salt to a silver solution. These reduce silver bromide superficially to silver. When the product is treated with nitric acid, what is left is pure, yellow silver bromide. Formaldehyde and caustic soda also reduce the silver bromide superficially without forming any photobromide. If sodium carbonate is substituted for the caustic, the bromide is not reduced at all. I have previously shown<sup>2</sup> that photobromide is formed when precipitated silver bromide and an excess of silver nitrate are reduced with formaldehyde and sodium carbonate; but this does not involve a reduction of silver. We have a reduction of the soluble silver salt to colloidal silver, which is adsorbed by the unreduced silver bromide. Silver bromide and an excess of silver nitrate behave in the same way with all reducing agents which are not powerful enough to reduce silver bromide itself. Similar results are obtained with silver chloride. In no case could I prepare photochloride by direct reduction of silver chloride. Even with hyposulphite, which was so much used by Carey Lea, I could not reduce the normal silver halides to photosalts. Silver bromide, precipitated with an excess of potassium bromide, was not perceptibly reduced even by hot concentrated solutions of sodium hyposulphite. When silver chloride is heated with a solution of hypophosphite, a colored product is formed but it is converted into normal silver chloride by treatment with nitric acid. When an excess of silver nitrate is present, both silver bromide and silver chloride yield photohalide when the silver nitrate is reduced by hypophosphite.

“It is now clear that no photohalide is formed by the

<sup>1</sup> Lüppo-Cramer: *Phot. Correspondenz*, 45, 266 (1908).

<sup>2</sup> Lüppo-Cramer: *Zeit. Kolloidchemie*, 2, 360 (1908).

direct reduction of halide salts. In fact, the action of reducing agents may even prevent completely the adsorption of halides by colloidal silver. I precipitated 10 cc of a silver gel suspension, (a) with 1 cc 10 percent KBr diluted with 9 cc H<sub>2</sub>O and (b) with the same amount of potassium bromide diluted with ferrous oxalate developer instead of water. The two silver precipitates were washed and then treated with nitric acid. A beautiful red photobromide was obtained from (a) and not a trace of photosalt from (b), only a slight clouding which was pure white in color. Metol developer also prevents the adsorption of potassium bromide by colloidal silver gel, even when adsorption has already taken place owing to the silver gel having received a preliminary treatment with potassium bromide. The effect produced by the iron developer is not produced by a ferrous sulphate solution, by potassium oxalate, solution or by soda solution alone; but a long soaking in a sulphite solution will prevent the adsorption.

"I have shown that the alkali halides react with colloidal silver to form photohalides only when the halide solution is dilute. Carey Lea made a similar observation in regard to the action of hydrochloric acid on his allotropic silver. He noticed that a very dilute hydrochloric acid formed more silver chloride with colloidal silver than did a concentrated acid. He explained this on the basis that the concentrated acid changed the allotropic silver into ordinary silver which then did not form silver chloride. When I allowed a large amount of concentrated hydrochloric acid to act on colloidal silver, there was only a slight clouding when the washed, gray silver was treated with nitric acid. This clouding is pure white in color and is therefore silver chloride and not photochloride. When very dilute hydrochloric acid was used, I always obtained red photochloride."

Lüppo-Cramer<sup>1</sup> has published some data on the behavior of synthetically prepared photochloride gelatine and on the analogous behavior of a chloride film which has been exposed to light.

<sup>1</sup> Phot. Correspondenz, 46, 493 (1909).

"In a previous paper<sup>1</sup> I have shown that the silver nucleus adsorbed in the photochloride acts chiefly as optical sensitizer and that clear light-images can be obtained on such films. The photochloride therefore has not the characteristics of a 'nucleus' and only acquires these when exposed to light. This discovery of mine was quite unexpected and seemed to be awkward for the theory of the latent image on silver chloride being an adsorption compound of silver. This objection was raised by Eder.<sup>2</sup> There are several things to be said in regard to this. The synthetically prepared silver chloride gelatine was treated with strong oxidizing agents to remove the soluble adsorbed silver. It is well known that such a proceeding weakens very considerably the latent image due to light or prevents its development. If the photochloride gelatine is not treated with oxidizing agents, the films develop rapidly and intensely either with chemical or physical development.

"It seemed rational to treat the photochloride formed by light in the same way as the synthetically prepared product. Fine-grained silver chloride gelatine plates were exposed to diffused daylight until they were colored pink and were then treated for 5 minutes with a chromic acid mixture,<sup>3</sup> after which they were washed thoroughly and dried. On these plates it was possible to develop strong pictures with an absolutely clear ground either by physical or chemical (ferrous citrate) development. The very fine-grained silver chloride films used at first, bleached nearly completely after treatment with chromic acid and consequently showed practically no color-sensitiveness. I therefore changed to a silver chloride emulsion having a somewhat coarser grain. Very satisfactory for this purpose was a recipe which I had found useful in making emulsified photochloride.<sup>4</sup> If one omits the colloidal silver and of course, the treatment with persulphate,

<sup>1</sup> Lüppo-Cramer: *Phot. Correspondenz*, 46, 273 (1909).

<sup>2</sup> *Phot. Correspondenz*, 46, 279 (1909).

<sup>3</sup> Five grams  $K_2Cr_2O_7$ , 15 cc concentrated  $H_2SO_4$ , 500 grams water.

<sup>4</sup> Lüppo-Cramer: *Kolloidchemie und Photographie*, 99 (1908).

one obtains a fine white emulsion which turns blue in the light and is not bleached by chromic acid. Such films, of photochloride prepared by light, show a panchromatism over the whole visible spectrum similar to that shown by my photochloride plates prepared by adsorption. We thus have in the photochloride films formed by light exactly the same behavior as in the synthetically prepared product. Experiments with silver bromide gelatine gave results of the same general nature.

"It is known that dry plates which have received a solarizing exposure, may be made ready to receive a new impression by treating with persulphate<sup>1</sup> or hydrogen peroxide.<sup>2</sup> It is clear that this is analogous to the behavior of the photochloride gelatine when treated with oxidizing agents, quite regardless of whether the silver nucleus is the result of exposure to light or of adsorption.

"If a highly-sensitive dry plate is given a strong solarizing exposure (5 minutes diffused daylight) under a Chapman-Jones plate tester and is then treated with chromic acid or persulphate (2.5 percent for 15 hours), the visible darkening remains almost unchanged, just as I stated years ago<sup>3</sup> and as Eder<sup>4</sup> also found. If such films are washed thoroughly and are then given a short exposure to diffused light, we get a reversed image and not a normal one when we develop either physically or chemically. The plate develops most readily on the places which were least changed during the first exposure, and develops least rapidly at those points where the solarizing exposure had produced the greatest and most visible blackening. This experiment is a variation of one which E. Albert<sup>5</sup> showed at the meeting of German scientists at Munich in 1899. Under the name of the Albert experiment it has since been the subject of much discussion.<sup>6</sup> In

<sup>1</sup> Schaum: *Phot. Correspondenz*, 39, 583 (1902).

<sup>2</sup> Lüppo-Cramer: *Phot. Correspondenz*, 39, 695 (1902).

<sup>3</sup> *Phot. Correspondenz*, 39, 694 (1902).

<sup>4</sup> *Ibid.*, 39, 648 (1902).

<sup>5</sup> *Archiv. wiss. Phot.*, 1, 285 (1904).

<sup>6</sup> *Ibid.*, 2, 4, 13, 21, 52.



this Albert experiment a very much over-exposed silver bromide collodion plate was treated with concentrated nitric acid, washed, and then exposed again to a diffused light. When developed one gets a direct positive. The variant of the Albert experiment with a dry plate is also evidently an extension of the previously described experiment with a plate giving a solarizing exposure to diffused light. It shows that the image produced by the second action of light is less readily developed, the stronger the first action of light was.

"Now we must not forget that a solarizing exposure gives normal images if the plate is treated with oxidizing agents before development and that therefore these latent images can be developed. It is simply that the development of the latent image, produced on these films by a second exposure, takes place much more rapidly than the development of the latent image due to the first exposure after this latent image has been treated with oxidizing agents. The important point in these reactions is the fact that the solarized image, the directly visible photobromide, only develops very slowly after it has been treated with chromic acid."

In a later paper, Lüppo-Cramer<sup>1</sup> goes back to the identity between the photohalides prepared by light and those prepared by adsorption.

"It was found [in the paper last quoted] that the photochloride obtained by adsorption, is readily reduced by the developer only when, in addition to the insoluble and firmly adsorbed silver, there is also in the silver chloride grain some free silver or some silver which is less firmly held. The photochloride obtained by light behaves in exactly the same way. If the soluble silver is removed, the remaining, firmly adsorbed, silver acts merely as an optical sensitizer. In this respect there is also a complete agreement between the two photochlorides, though prepared in such different ways. The products obtained by the action of light on silver bromide we have similarly as can clearly be seen in the so-called Albert experiment.

<sup>1</sup> Phot. Correspondenz, 47, 128 (1910).



"I have elsewhere remarked that the interesting characteristic of the synthetically prepared silver bromide, of giving reversed pictures on development after an exposure, is apparently not in harmony with the reactions of the photochlorides or with the behavior of the photobromides when obtained by exposure to light. The analogy is, however, really complete. The photobromide gelatine emulsions, as appears from my careful description of the method of preparation, were treated with a fairly dilute nitric acid, in order to prevent any disturbing liquefying action of the acid on the gelatine of the emulsion. Under these conditions, what silver was really 'free' was removed but we did not remove all the silver that could be taken out by oxidizing agents. If the dried photobromide film is dipped again into a strongly oxidizing solution, 10 percent chromic acid for instance, there is no change in the color of the film, but such plates then give normal images when developed just as do the photochloride gelatine films. When photobromide gelatine is treated with strong oxidizing agents it behaves exactly as does silver bromide when given a solarizing exposure and then treated with strong oxidizing agents. The agreement is so complete that I could illustrate the effect of chromic acid in eliminating reversals on my synthetically prepared photobromide plates by means of the pictures which Eder<sup>1</sup> has published in connection with his investigations on the elimination of photochemical solarization by chromic acid.

"The solarization of silver bromide is forced back by substances, like hyposulphite or sulphite, which dissolve silver bromide, and the reversing action of light on the synthetically prepared photobromide is also checked by these substances. It was often observed that where the light had bleached some of the fields under a plate tester, the color became darker when the film was treated carefully with substances which dissolve silver bromide. What happens is that the lighter portion, where the silver bromide has been

<sup>1</sup> Eder and Valenta: *Sitzungsber. Akad. Wiss. Wien*, 113, II, 168 (1904).

superficially regenerated is dissolved and the darker photobromide is exposed.

"Another important agreement between the synthetically prepared photohalides and the photo-decomposition products of the halides is the decrease in sensitiveness which comes to the silver halide from the adsorbed silver regardless whether the silver is obtained by exposure to light or by direct adsorption."

Some recent experiments by Reinders<sup>1</sup> have helped greatly to clear up the whole question of the photohalides. He considers that Luther's experiments on the existence of a subbromide and subchloride have been entirely discredited by the later work of Heyer<sup>2</sup> from the same laboratory. Reinders has fused silver and silver chloride together and he has shaken them together in presence of concentrated ammonia for 14 days both at 100° and at 20°. These experiments were carried on in the dark and gave negative results. He also ran a series of experiments in which silver chloride was allowed to crystallize from solution in daylight. His conclusions are as follows:<sup>3</sup>

(1) It has been shown that no stable compound of metallic silver and silver chloride is formed either at high or at low temperatures.

(2) When silver chloride crystallizes from solution in diffused daylight, the crystals are colored uniformly throughout: blue from ammoniacal solution; red from hydrochloric acid solution; and blackish gray from mercurous nitrate solution.

(3) From an ammoniacal silver chloride solution containing colloidal silver there separate, in the dark, crystals which are colored yellow, orange, brown, red or pale lilac. On exposure to light the color changes from yellow through red and violet to blue. The crystals have exactly the same form as the pure silver chloride. The colloidal silver may be

<sup>1</sup> Zeit. phys. Chem., 77, 213, 256, 677 (1911).

<sup>2</sup> Jour. Phys. Chem., 15, 557, 560 (1911).

<sup>3</sup> Reinders: Zeit. phys. Chem., 77, 225 (1911).

obtained from an ammoniacal silver chloride solution by reduction with very different reducing agents either with or without protecting colloids. The nature of the reducing agent has no effect on the general properties of the photochloride.

(4) The crystallized photohalides are more sensitive to light than pure silver chloride; they reach a more intense, final blue color than pure silver chloride; and this color extends throughout the mass of the crystals.

(5) In concentrated solutions of ammonia or sodium hyposulphite the photochloride dissolves to a colorless solution of silver chloride, the excess of silver remaining as a black powder. In the case of some very dark blue samples, this excess varied from 0.5-1 percent. In most crystals it was much less, barely a few tenths of a percent.

(6) If a little gelatine is added to the ammonia solution, the photochloride dissolves completely, forming a silver solution, the color of which varies with the color of the photochloride, the blue crystals giving a red solution and the red crystals a yellowish brown one.

(7) Colloidal gold and some organic dyes are taken up by silver chloride, the crystals being uniformly colored. The crystals of potassium, rubidium and caesium alums can be stained with colloidal silver.

(8) Photochloride is silver chloride colored with adsorbed colloidal silver."

This last conclusion is amplified in the second paper where Reinders<sup>1</sup> brings together all the facts which tend to show that the properties of the photohalides depend on a content of colloidal silver. He presents the following arguments:

(1) The different colors of colloidal silver are yellow, brown, pink, red, violet, blue, green. The colors of the photohalides are yellow, orange, pink, red, violet, and blue or green.

---

<sup>1</sup> *Zeit. phys. Chem.*, 77, 363 (1911).

(2) The photohalides are formed when silver and silver halide are precipitated simultaneously from colloidal solution.

(3) Crystallized photochloride is formed by evaporation of ammonia from a solution containing silver chloride and colloidal silver.

(4) In concentrated ammonia the photochloride dissolves, leaving a residue of black, insoluble silver. In dilute ammonia, or in concentrated ammonia to which a protecting colloid has been added, the photochloride dissolves completely. There is formed a solution of colloidal silver, the color of which varies with the color of the photochloride. A copper-colored photochloride gives a yellow solution, red crystals a brownish yellow one, and a blue photochloride a red solution. The excess of silver must evidently be in the solid photochloride in a state similar to that in which it occurs in the solution, namely in a finely-divided, colloidal state.

(5) The fact of a salt adsorbing free metal when in the colloidal state is not confined to silver halides and silver. Colloidal gold is adsorbed by silver chloride and colloidal silver by other salts.

(6) The photohalides are sensitive to light. In white light they become red, violet and finally blue; in colored light they assume the color of the incident light.

“Colloidal silver is also sensitive to light and changes color in a way depending on its mode of preparation and its original color. Carey Lea<sup>1</sup> says in regard to this that all the forms of silver are affected by light. When exposed to sunlight for some hours, A and B (brilliant bluish green when dry, and red, lilac, blue or green when moist) assume a brownish tone. The behavior of C (brilliant gold color when dry and dark brown when wet) is quite different, the color changing from a red to a yellow gold.

“Lüppo-Cramer<sup>2</sup> has also noticed that, when a solution of silver nitrate and gelatine had been reduced in the dark by

<sup>1</sup> Am. Jour. Sci., [3] 38, 47 (1889).

<sup>2</sup> Zeit. Kolloidchemie, 7, 99 (1910).

hydroquinone to a grayish blue solution, its color changed on exposure to light, from blue through violet and red to yellowish brown.

"There are also some remarkable observations by Waterhouse<sup>1</sup> who found that silvered glass or copper plates showed distinct traces of a visible image after being exposed to light for an hour or two. This image could be developed with mercury vapor or with a ferrous sulphate solution and silver nitrate (physical development). After a very long exposure a reversed image was obtained on development with mercury. The mercury precipitated on the unexposed places whereas it precipitated on the high lights when the exposure was shorter. We have thus a solarization which differs in some respects from solarization in silver bromide gelatine but which suggests the possibility of referring solarization in dry plates to a change in the physical state of the silver particles set free by light."

"All the properties point to the photohalides being normal salts of silver which are colored by a small amount of colloidal silver. We can picture to ourselves the way in which the particles of colloidal silver are distributed through the silver halide crystals as being similar to that postulated by Siedentopf for the distribution of metallic sodium through blue rock-salt. The different properties of the photohalides must be due to the number, the shape, and the distribution of the particles of colloidal silver through the solid silver halide. When the photohalides are exposed to light we get the same order of colors, yellow, orange, red, violet and blue which we get from the reduction of gold or silver solutions, the series ending with the coagulation of the metal. Consequently it is probable that the difference in the color of the photohalide is due chiefly to a difference in the size of the particles of silver."

In the third paper Reinders studies the effect of gelatine and of dyes on silver chloride. He sums up his conclusions<sup>2</sup> as follows:

<sup>1</sup> Proc. Roy. Soc., 66, 490 (1900).

<sup>2</sup> Reinders: Zeit. phys. Chem., 77, 696 (1911).

(1) It has been shown that silver chloride, when crystallizing from an ammoniacal solution, may take up colloidal gold or silver, or many other substances such as most dyes, gelatine, albumen, caseine, etc., these substances being distributed uniformly through the crystals.

(2) While most of the dyes do not affect the crystalline form of the crystals, some cause a marked formation of dendrites and an irregular twinning of the crystals. The concentration of the dye has an effect, the tendency to the formation of dendrites increasing with increasing concentration.

(3) The ratio of the concentrations of the dye in the crystals and in the solutions was determined for erythrosine and Rose Bengale. With the first the ratio increased from 20-200 with increasing concentration of the dye, while with the other the ratio had a value of about 90 and was practically independent of the concentration of the dye.

(4) Gelatine and adsorbed albuminoids increase very much the sensitiveness of silver chloride to light. This effect can still be detected with crystals separating from a solution which contains only 1 mg of gelatine in 10 liters.

(5) The taking up of colloidal silver is checked or completely prevented by the presence in the solution of other substances like gelatine and agar agar, which are themselves readily taken up."

Reinders believes that we have a true solid solution of silver in silver chloride. He does not believe that it is a question of surface adsorption.

Lüppo-Cramer<sup>1</sup> has made a series of interesting observations on the colors of the photohalides.

"In previous papers<sup>2</sup> I cited a number of phenomena to show that the manifold colors of silver are also duplicated in the different, colored photohalides. More convincing than any argument is a glance into Siedentopf's cardioid ultra-microscope. Through the kindness of Dr. Siedentopf I recently had the opportunity in Jena of comparing Carey

<sup>1</sup> Phot. Correspondenz, 48, 33 (1911).

<sup>2</sup> Ibid., 47, 337 (1910).

Lea's silver solution and the photochemical decomposition of silver bromide under a cardioid ultramicroscope. I can confirm Siedentopf's statement that there is a very convincing similarity under the ultramicroscope.

"With the ultramicroscope we see the color of the silver direct or the complementary color of the reflecting disks. To the naked eye the colors of the photohalides formed by light may often seem indistinct because, with the coarse-grained films of the ordinary dry plates, there are formed particles of very different size and distribution, and the mixture often gives little more than a slightly colored gray. It is much easier to study the color of the photohalides and its dependence on the silver as dye with the synthetic product rather than with the photohalides formed by exposure to light. We then get the same change from yellow through red to violet and blue which we obtain by increasing the size of the particles of colloidal silver.<sup>1</sup>

"If we add small amounts of colloidal silver to a silver bromide having a marked gel structure, the original yellow color changes in a few minutes to a rose pink and in 15-20 minutes the dye in the red photobromide is so fast that nitric acid does not remove the color at all. The farther color change of the bromide from red to violet and blue depends on various things, each one of which has to do indirectly with the increase in the size of the particles. We must consider the silver bromide gel as a sort of sponge in which the pores have a certain diameter which is ultramicroscopic in size. The silver penetrates these pores only so long as the silver bromide retains its spongy structure. In the course of 30-40 minutes at ordinary temperature, the gel changes spontaneously to such an extent that it cannot be stained by silver. It can no longer be peptonized and it has lost the characteristics of a gel. The contraction of the silver bromide also takes place when small quantities of colloidal silver have entered the pores. As the silver bromide contracts, there

<sup>1</sup> Lüppo-Cramer: Zeit. Kolloidchemie, 7, 99 (1910).

is an increase in the size of the particles of the occluded silver. The photobromide therefore changes to red and also to violet and blue when there is enough silver present and when a contraction of framework of the silver bromide gel is brought about, for instance by boiling. If there is an excess of silver, it prevents the change of the silver bromide gels, just as organic dyes do. The silver collects in the pores but chemical agents like nitric acid are able to dissolve the silver. We have a typical case of anomalous adsorption, the name given by Biltz and Steiner<sup>1</sup> to similar phenomena with dyes, such as the dyeing of textile fibers or of carbon.

"The conditions for studying the color changes of the photohalides are more favorable when the two hydrosols are coagulated simultaneously than when one stains silver bromide with silver. The conditions for the occlusion of the dye (silver) in the silver bromide gel are so much better that the resulting photohalides are colored more intensely. The more silver there is present, the greater is the growth of the yellow particles which originally were very small and consequently the color from red to violet and blue with increasing amounts and silver. When we get very large amounts of silver, we have anomalous adsorption again.

"One cannot make yellow photohalides in this way unless one is willing to call the uncoagulated mixture of the hydrosols a photohalide. The action of light produces a yellow photochloride if the grain of the silver chloride is extraordinarily fine, such as one gets by disintegrating a fine-grained silver chloride, emulsified in gelatine, by means of Röntgen rays or electrical discharges. With silver bromide of a particular grain, the disintegration by Röntgen or radium rays, by ultraviolet light or by shearing pressure, yields so fine a grain that the silver bromide becomes red on exposure to light. In other words, the particles of silver cannot grow beyond the size for red silver. With the printing-out paper an increase in the size of grain causes a change in the print

---

<sup>1</sup> *Zeit. Kolloidchemie*, 7, 113 (1910).



from red to violet and blue, though it must be admitted that other factors may play an important part in this change.<sup>1</sup>

"Distinctly *green* photohalides apparently cannot be made synthetically. I have never found any reference to one in the writings of Carey Lea or of anybody else<sup>2</sup> and my efforts to prepare green photohalides have been in vain. The reason for this probably is that green silver consists of fairly large particles which are not suitable for occlusion by the silver halide gel. That green silver has the largest particles follows indirectly from all the data.

"When the grain of the silver halide is broken up by radiant energy, a fine-grained salt is formed which yields a red or a yellow photohalide, and, conversely, a blue-violet photobromide changes to pink when peptonized. Prof. Reinders in Delft has recently made some interesting experiments along this line with crystallized photochlorides. When red photochloride was dissolved in dilute ammonia in presence of gelatine, Reinders obtained a yellow silver, while red silver was obtained on dissolving the blue photochloride. There is apparently a peptonizing decrease in the size of the silver particles, analogous to what takes place in the ordinary fixing with hyposulphite."

"A similar decrease in the size of the particles of silver evidently takes place in the photochromy of Poitevin,<sup>3</sup> though here the change is a purely chemical or photochemical one. A silver chloride, which has darkened to a bluish violet shade is impregnated with bichromate. When exposed to the

<sup>1</sup> Lüppo-Cramer: Photographische Probleme, 54 (1907).

<sup>2</sup> It is not fair to count Baur's photochlorides having olive-green or absinthe shades because these contained a large excess of silver which itself had that color.

<sup>3</sup> Since this was first written I have found that blue silver solutions, obtained by means of nuclei, can be changed by oxidizing agents such as persulphates first into red and then into blue solutions. Green silver solutions are also changed slowly by persulphate into red and then yellow before the silver dissolves completely. It is evident that this result is of great importance for the photochromy of silver, for the problem of photochromy, and for the problem of photohalides.

oxidizing action of the red and yellow rays, there is a change of color to red and orange. The blue and violet rays, on account of their reducing action, cause a further reduction in spite of the bichromate."

Carey Lea<sup>1</sup> has the following to say in regard to reversals with photobromide: "If we take the red or purple silver bromide, preparing it with exclusion of light and the same precaution as in the case of any plate, and extend it over paper (it is best, though not essential, to mix it with a little gelatine to enable it to retain its hold on the paper in the subsequent treatment) dry it and expose it to the light under a screen such as a piece of opaque stiff pasteboard with openings cut in it; then apply potassio-ferrous oxalate, we shall obtain a very remarkable effect. All the parts exposed to light take a reverse development and appear as lighter spaces on a darker ground. And this goes so far that we may expose till we get the visible and quite strong image darker than the ground and yet in development this darker portion will come out lighter than the ground. Indeed I have one specimen which shows almost white figures on an intensely black ground. Before development these light figures were brown, by exposure to light, on a rose-purple ground. I have seen few more curious results than this.

"From the foregoing it follows that red bromide, notwithstanding its intense coloration is in the same condition respecting light as normal silver bromide that has received an impression of light so strong that any further influence of light would cause reverse action, only that a vastly larger proportion of its molecules are affected. In the case of the latent image formed by light on normal bromide it would seem that the particles affected, although numerous enough to serve as a basis of development, are still too few and too scattered to be visible or affect the color. The photobromide on the contrary has its mass made up of them. Then, if exposed to light, the light carries them a stage farther—brings

---

<sup>1</sup> Am. Jour. Sci., [3] 33, 487 (1887).

them to the reverse or solarized condition and the parts affected by light develop less strongly than those not exposed."

Lüppo-Cramer comments<sup>1</sup> on this as follows:

"In one of my previous papers<sup>2</sup> I have given a reproduction of a picture on a photobromide gelatine plate from which one can see that the extraordinarily surprising result described by Lea can easily be reproduced. I have also pointed out that we are not dealing with a reversal due to over-exposure but that any exposure, which has any effect at all, decreases the rate of development of the photobromide. My experiments on the gelatine emulsion of the photobromides yielded a number of results which were interesting in themselves. I prepared a large supply of photobromide plates in the following way.

"Since my experiments have shown that the photohalides are the halides colored with colloidal silver, they can be prepared easily by coloring the halides. It is not necessary to prepare the silver solution separately because one can precipitate silver bromide with an excess of silver nitrate and then can add a mild reducing agent such as ferrous citrate<sup>3</sup> which will reduce the soluble silver salt to colloidal silver but which will not reduce the silver bromide. After the reduction product has been washed for a while, it is treated with nitric acid to remove the uncombined silver. In this way there is obtained a beautifully violet-colored photobromide which can readily be peptonized by bromide ions in gelatine to a homogeneous, fine-grained, pink emulsion. After the bromide salts have been washed out, the emulsion can be worked up in the usual way.

"These red photobromide plates behave in a very remarkable way when exposed to daylight. They do not become darker, as was the case with Carey Lea's paper; but they *bleach* to a *light grayish white* after an exposure of

<sup>1</sup> Phot. Correspondenz, 46, 397, 415, 424 (1909).

<sup>2</sup> Ibid., 46, 275 (1909).

<sup>3</sup> Cf. Lüppo-Cramer: Zeit. Kolloidchemie, 2, 360 (1908).

several minutes to diffused light. If the film is exposed to daylight for about half an hour under the Chapman Jones plate tester, one notices, even with yellow light, a surprising effect which I confess is *one of the most remarkable in my experience*. The whole scale comes out a light gray to white on the red ground and it looks as though the photobromide had been changed back into silver bromide. If the plate is placed in the ordinary metol developer, there appears, in a short time, a clear but reversed image on a black ground. It is interesting to note that, with a longer exposure of about an hour and a half, the first fields show distinctly the beginning of the second reversal of the solarization, the first numbers of the scale developing dark instead of light. An ordinary silver bromide plate (Schleussner yellow label) does not show any signs of a second reversal when exposed for 6 hours. As analogy to the second reversal of the solarization, a prolonged exposure of the photobromide film causes a bleaching and then a darkening. In this later stage a distinct residue is left if the plate is fixed. This new darkening of the bleached photobromide has no definite color and is a neutral gray. If the photobromide gelatine is dipped in a 1 percent silver nitrate solution and then exposed under the plate tester, the result is quite different. The light does not bleach the plate but makes it darker. On development we get a normal image though one that is badly fogged regardless of whether we develop physically or chemically. This experiment is in line with the fact that halogen absorbers prevent the occurrence of solarization<sup>1</sup> with ordinary silver bromide gelatine. Moistening the photobromide film with sodium nitrite also causes a rapid and intense darkening in the light.

“These reactions made it seem possible that the small amount of colloidal silver might have been converted into silver bromide, on exposure to light, by the traces of bromide from the peptonization, since perhaps they could not be washed out of the photobromide. Therefore the excess of

<sup>1</sup> Lüppo-Cramer: Photographische Probleme, 139 (1907).

silver was removed from the photobromide with nitric acid and the photobromide was merely washed and then taken up in gelatine without any addition of bromide. If one makes use of the artifice which I employed with pure silver bromide, only to take a little gelatine at first, the photobromide can be got into a fine suspension very satisfactorily, though by no means so well as with the aid of bromide. These films also bleached in the light though there was a preliminary darkening in some of my many experiments. But even these plates behaved like Carey Lea's paper and always yielded reversed images on development. From these experiments we see that it is not permissible to assume that the bleaching of the photobromide is due to the action of traces of bromide left in the film. The residue left after fixing plates, which have been exposed till they bleached or until they darkened again, indicate that, taking the films as a whole, there are more silver nuclei formed the longer the exposure. Before offering explanations of these interesting facts, there are a few more experimental data to be given.

"The method of preparing photobromide by reduction of a soluble silver salt, in presence of silver bromide, by a reducing agent yielding a suitable colloidal silver is a method which gives a very variable photobromide. For this reason I have repeated the preceding experiments with a photobromide prepared in another way. As I have previously stated,<sup>1</sup> photobromide can be prepared by the simultaneous precipitation of the hydrosols of silver bromide and silver. The hydrosols themselves show no tendency to combine as I have often remarked explicitly with deference to the popular superstition that silver bromide, and silver react to form a subbromide. If one adds colloidal silver to a silver bromide solution, there is only a slight yellow to brown discoloration, depending upon the amount of silver added. The mixture of the solutions often remains unchanged for days. The addition of any electrolyte, such as  $\text{Na}_2\text{SO}_4$ ,  $\text{H}_2\text{SO}_4$ , or very

<sup>1</sup> Lüppo-Cramer: *Kolloidchemie und Photographie*, 74.

dilute  $\text{HNO}_3$ , is sufficient to change the color to an intense red or violet and to cause the coagulation of a photobromide which is not acted on even by concentrated nitric acid. I do not at all see how, in view of this simple experiment, one can maintain that a subbromide must be formed. Somebody might perhaps reason as follows. The solutions are stable only when certain ions are present in excess of the theoretical equivalents and consequently the slight excess of bromide necessary to form the silver bromide hydrosol might form hydrobromic acid when the solution was coagulated with sulphuric acid and this hydrobromic acid might convert some silver into  $\text{Ag}_2\text{Br}$ . This difficulty is easily overcome because photobromide is also formed when the hydrosol is prepared with an excess of silver nitrate."

"In order to get a product which will show the photobromide reactions well, it is necessary not to color this silver bromide with too much silver. The following directions have been found to give the best results. I have tested them about twenty times.

"To two liters of carefully distilled water are added 3 grams  $\text{KBr}$ ; to another two liters of similar water exactly 4 grams  $\text{AgNO}_3$  are added. The silver solution is then added to the bromide solution, the mixture being shaken continuously. A bluish white opalescent solution is formed. To this silver bromide is added 1 cc of colloidal silver made according to Carey Lea's directions with ferrous citrate<sup>1</sup> and containing 1.6 percent  $\text{Ag}$ . This small amount of silver, only about 0.4 percent of the silver bromide, merely colors the solution a bit yellowish. As soon as an electrolyte is added, the solution becomes a bright reddish violet. Add 100 cc concentrated  $\text{H}_2\text{SO}_4$  and shake vigorously for a while. Voluminous, coalescing lumps settle to the bottom and the supernatant liquid is poured off even though it still has some very fine photobromide suspended in it. The gel is to be treated with nitric acid (10 cc concentrated  $\text{HNO}_3$  + 10 cc

<sup>1</sup> Am. Jour. Sci., [3] 37, 481 (1889).

H<sub>2</sub>O). If some silver goes into solution it shows that less than the 0.4 percent Ag has been adsorbed. The beautiful, bright red photobromide is to be thoroughly washed and then 100 cc 10 percent gelatine + 1 gram KBr, heated to 60° is poured over it. The peptonization takes place slowly and is helped by a continuous, powerful shaking. After 15-30 minutes a homogeneous, fine-grained emulsion is obtained, which is poured and then washed thoroughly. If one uses ten times the amount of silver solution, the photobromide is colored more intensely and does not show the bleaching in light so clearly, though it can be detected. On development all the preparations, which I have made, give reversed pictures so that this is independent of the conditions of the experiments, at any rate within very wide limits."

"I prepared photoiodide by simultaneous coagulation of the hydrosols of silver iodide and silver, the details being like those in the preparation of photobromide. When the gel was treated with dilute nitric acid, I obtained a dirty red photosalt which emulsified to some extent in gelatine after much shaking. It was easier to emulsify the salt if a little potassium iodide was added as a peptonizing agent to the mixture of photoiodide and gelatine; but I have made the decisive experiments with plates made from emulsions not peptonized with potassium iodide because iodides are very readily adsorbed by silver iodide.<sup>1</sup>

"If one brings the wet and swollen, red photoiodide gelatine out into daylight, it bleaches in a few minutes to a very pure yellowish white. This quick and complete bleaching, which I had previously noticed with photoiodide containing no binder,<sup>2</sup> does not occur if the film is dried; in that case the photoiodide bleaches only to a bright green. In connection with this it is interesting to note that Baur<sup>3</sup> says, in regard to his photochloride gelatine emulsions that in the light the purple color changes to the bright grayish green

<sup>1</sup> Cf. Lottermoser and Rothe: *Zeit. phys. Chem.*, 62, 359 (1908).

<sup>2</sup> Lippo-Cramer: *Phot. Correspondenz*, 44, 539 (1907).

<sup>3</sup> Eder's *Jahrbuch für Photographie*, 18, 609 (1904).

of the most finely divided silver. Baur says that it is evident that the same reduction takes place through the gelatine as with the silver chloride gelatine papers in the light. On the other hand, my experiments showed that, at any rate for the photobromide and photoiodide, a chemical action of gelatine is not necessary to cause bleaching because the photohalides bleached in the light both when no binder was present and when they were suspended in collodion. A statement by Guntz<sup>1</sup> is also of interest here. According to him, the originally violet silver subchloride becomes gray on prolonged exposure to light, owing, as Guntz says, to the subhalide being decomposed by light into silver and chlorine. Nitric acid will then dissolve the silver. As against this, my photochloride gelatine plates were not attacked at all by chromic acid or nitric acid even after they had been blackened considerably by light.

"This experiment shows that the bleaching of the photoiodide, like that of the photobromide<sup>2</sup> is not dependent on the presence of oxidizing agents or halide salts. The bleaching is however prevented and replaced by a photochemical blackening as soon as a halogen absorber is added, such as silver nitrate or potassium ferrocyanide. The direct photochemical changes thus seem to be the same as with the photobromide. On the other hand, the photoiodide does not behave on development like the photobromide. All my experiments have confirmed Carey Lea's statement that the photoiodide gives normal images, ones that are not reversed. This is the more surprising as silver iodide gelatine is extraordinarily prone to solarization,<sup>3</sup> so that we are again stirring up new problems

<sup>1</sup> Eder: *Photochemie*, 209 (1906).

<sup>2</sup> Since my photochloride films always became darker in the light, while the photobromide and photoiodide always bleached, there was a possibility that the radically different method I used in making the photochloride might be a factor. I therefore prepared photochloride by simultaneous precipitation of the hydrosols of silver chloride and silver in a way exactly similar to that used in making photobromide. These photochloride films also darkened when exposed to light and consequently the nature of the halogen must determine how the photochloride behaves.

<sup>3</sup> Lüppo-Cramer: *Photographische Probleme*, 152.



instead of solving old ones. Photoiodide gelatine, like silver iodide gelatine, can best be developed physically. It possesses a similar color-sensitiveness to silver bromide and silver chloride stained with silver. My emulsions of photobromide and photoiodide, however, did not reproduce colors as such; but, under the influence of all colors, there was a uniform bleaching to a light grayish green. According to Carey Lea<sup>1</sup> his photobromide reproduced colors fairly well up to a certain point, and it is especially interesting that, under yellow glass, papers bleached which became dark in the light. In regard to the change of the photoiodide by light, Lea<sup>2</sup> merely says that light acts slowly upon it, changing the color to greenish gray. I found that blue light is the most effective in causing the photobromide to reverse.

"For an account of the many contradictory statements as to the different photohalides bleaching to white and of the many experiments, from Seebeck to Günther, to account for this phenomenon, I refer to my earlier papers on the photochemistry of the photohalides.<sup>3</sup> I should like to add as a historical notice, that, according to Zenker,<sup>4</sup> it was shown by J. Herschel that silver bromide takes on the same colors as silver chloride, though much less distinctly, while silver iodide acts in the opposite way and change to the complementary colors. Hrudnik<sup>5</sup> also observed something similar in his experiments. It should also be mentioned here that Becquerel<sup>6</sup> observed that the development of color on silver chloride was prevented by the presence of silver nitrate.

"The experiments with the three photohalides have a bearing on the theory of the latent image because they show that it is not permissible to consider the possibility of development being solely a question of the presence of nuclei. There are other factors to be considered. It was especially

<sup>1</sup> Am. Jour. Sci., [3] 33, 491 (1887).

<sup>2</sup> Ibid., [3] 33, 493 (1887).

<sup>3</sup> Phot. Correspondenz, 44, 376 (1907).

<sup>4</sup> Lehrbuch der Photochromie, 2nd Ed., 41, 103 (1900).

<sup>5</sup> Phot. Correspondenz, 40, 545 (1903).

<sup>6</sup> Zenker: Lehrbuch der Photochromie, 2nd Ed., 42 (1900).

clear in the case of the photochloride, that this substance had no affinity for nascent silver. Theoretically the conditions are similar with the photobromide<sup>1</sup> and the photoiodide. If one tries to develop an image physically on photobromide gelatine after an exposure under the Chapman Jones scale which would give with chemical development the picture reproduced in a previous article, nothing can be seen to develop by the yellow light of the dark room. If the development with the metol-silver intensifier is continued for 10 minutes and the plate is then fixed, the part which has not been exposed to light shows a slight fog as compared with a check plate which has been fixed immediately after exposure. The first three rows of the scale come out in blue on a neutral gray ground, while the last two rows also show a bleaching of the ground. The whole image is very thin while an image on a silver chloride or a fine-grained silver bromide plate would have given a dense image if developed for 3 or 4 minutes with the fast-working metol-silver intensifier. The photobromide check plate, which had been fixed without being developed, showed a bright precipitate of silver on the first three rows of the scale. This proves that the bleaching of the photobromide in the light is accompanied by a progressive reduction of the grain. The ability of the photobromide to act as a nucleus is thus not very well marked. I hope some day to make a more thorough study of the photoiodide.

From what has been said, it is clear that the action of the three photohalides towards the developer has given a new twist to the problem of the latent image."

In a later paper Lüppo-Cramer<sup>2</sup> discusses the behavior of photobromide emulsions containing a smaller excess of silver.

<sup>1</sup> I have shown [Phot. Correspondenz, 40, 275 (1903)] that the substance composing the latent image in silver bromide collodion seems not to be reduced by the developer to pure silver. A similar result was obtained later by Weisz [Zeit. phys. Chem., 54, 332 (1906)] with silver bromide films containing no binder. He concludes that the solid solution is very resistant to reducing agents.

<sup>2</sup> Phot. Correspondenz, 46, 526 (1909).

"The photobromides, hitherto under discussion,<sup>1</sup> were prepared by dyeing silver bromide with an excess of silver and removing with nitric acid the silver which had not been adsorbed. For several reasons, which will appear later, it seemed desirable to determine how photohalides would behave if they contained less adsorbed silver. In the previous experiments 0.4 percent silver (with reference to silver bromide) was added and a part of this was dissolved by nitric acid, I consequently studied an emulsion containing only 0.1 percent silver (one part of silver to one thousand of silver bromide). Since it turned out that a treatment with nitric acid was unnecessary, this was omitted and the photobromide gelatine emulsion was prepared according to the following simplified method.

"The hydrosol was made from 4 grams  $\text{AgNO}_3$  and 3 grams  $\text{KBr}$ , each dissolved in two liters of water. Eight portions of the hydrosol (corresponding to 32 grams silver nitrate) were treated in a large flask with the theoretical amount of silver solution and precipitated with sulphuric acid. The precipitated gel was washed and then peptonized for 15-30 minutes at  $50^\circ$  in a solution consisting of 80 grams gelatine and 8 grams  $\text{KBr}$  in 800 grams water. The emulsion was made to solidify, was washed, and was poured from a pouring machine. Preparing the emulsion on such a scale requires rather more work; but it is worth while, on account of the greater uniformity of the product because slight differences are compensated. It is a familiar fact that when photographic emulsions are made on a very small scale, the unintentional variations are often greater than the intentional ones.

"The other photobromide, which we will henceforth call the photobromide with 0.4 percent  $\text{Ag}$ , was colored a very intense red; but the one with 0.1 percent  $\text{Ag}$  is a beautiful pink when in the form of the precipitated gel and only shows a pale pink when made up into a gelatine film. This bleaches

---

<sup>1</sup> Lüppo-Cramer: *Phot. Correspondenz*, 46, 397 (1909).

in the light almost instantaneously to white, much more rapidly than the films with 0.4 percent Ag. This was to be expected in view of my earlier experiments and of the explanation I have given for them. We might also have predicted the extraordinarily important fact that the film with 0.1 percent silver is much more sensitive (about 25 times) than the film with 0.4 percent Ag. The silver nuclei in the 0.1 percent Ag film are evidently just as effective as the larger number in the older plates so far as making the unexposed plates blacken in the developer, because the new plates blacken in a metol-soda developer just as rapidly and just as much as those containing more silver. Since the reversing action of the light on development cannot in the nature of things be due to anything else than to a bromination of the adsorbed colloidal silver nuclei by the bromine coming from the inner portions of the grain—proved by the direct bleaching of the photobromide films in the light—anything over a definite maximum of adsorbed silver will decrease the sensitiveness of the photobromide film because it will call for more bromine. This was the reasoning which led to the experiments already described and which caused me to try cutting down the amount of the silver still more, the method of preparing the photobromide emulsion remaining the same. Films were prepared in which the silver bromide contained 0.05–0.01 percent, and 0.002 percent Ag respectively. From these experiments it appeared that the film in which the silver bromide contained 0.1 percent Ag was the best in that it was the most sensitive. With decreasing amount of silver, the rate of blackening in the developer decreased and the experiments showed that possibly the more rapid bromination of the silver may be compensated to some extent in the final result. That the color visible before development should decrease, as well as the optical sensitiveness, with decreasing amount of silver was to be expected. It is interesting however to note that even with 0.002 percent Ag there is a distinct fogging of the silver bromide on development. In order to be certain of this, a silver bromide emulsion containing no excess of

silver, was prepared from the hydrosol in the same way as the photobromide. We shall refer to these pure silver bromide plates hereafter as silver bromide gel plates.

"When gold nuclei are incorporated in the silver bromide gel in the way described for the photobromide, they cause a rapid blackening in the developer. The colloidal gold for the purpose can be made very easily by Carey Lea's method for colloidal silver, reducing with an alkaline dextrine solution. To 10 cc of a 10 percent dextrine solution is added 0.5 cc of a 10 percent NaOH and then 5 cc of a 1 percent gold chloride solution, after which the solution is diluted to 100 cc. Reduction begins very quickly and in half an hour one has a very beautiful ruby-red gold solution, which is very stable owing to the protecting action of the dextrine. To the silver bromide hydrosol from 32 grams  $\text{AgNO}_3$ , 75 cc of the gold hydrosol are added and the further treatment of the mixed solutions is exactly like that for making the photobromide. The silver bromide gel, thus stained with gold, is greenish gray just as I found in my earlier experiments when I was showing silver chloride would take up colloidal gold as well as silver.

"In the first paper on the development of photobromide gelatine,<sup>1</sup> I pointed out that the reversing action of light on the photobromide film corresponds to the ordinary solarization to the extent that it is destroyed by halogen absorbers. I obtained the same result with all the photobromide films containing small amounts of silver, impregnating the films with sodium nitrate. The chemical sensitizer caused a very rapid direct coloring in the light. On development, badly fogged normal images were obtained and not reversed ones. I have previously mentioned that the photobromide gelatine containing 0.4 percent Ag showed the beginning of the second reversal when exposed for a long time. This interesting phenomenon can be observed very well with plates containing only 0.1 percent Ag. One plate was exposed under the

<sup>1</sup> Lüppo-Cramer: Phot. Correspondenz, 46, 417 (1909).

Chapman Jones plate for an hour, and a second for 5 hours. The unexposed portions of the edge, where it has not been disturbed by halation, show the original blackening; the first reversal appears from No. 12 on for the first plate and from No. 16 on for the second plate; the second reversal shows on the earlier numbers. The second reversal begins very early with these films; 10 minutes' exposure carries the first numbers over. With ordinary dry plates the second reversal of the solarization is very hard to get and special precautions are necessary in order to make it recognizable.<sup>1</sup> An experiment with the silver bromide gel plates, containing no silver nuclei, showed that the great tendency to the second reversal is not primarily due to silver nuclei; but is chiefly a question of the structure of the grain, for the plate containing no nuclei showed the second reversal on the first fields of the scale after a relatively short exposure while a Schleussner transparency plate of approximately the same sensitiveness, when exposed for the same length of time showed only slight signs of the first reversal in the first two fields. Even the highly-sensitive Schleussner plates only showed the first reversal of the solarization partially. I have reported in the first paper that the highly-sensitive Schleussner plate does not show any signs of the second reversal after an exposure of 6 hours. If the reversing action is due to a emigration of bromine from the inside of the grain to the surface, it is intelligible that its first and the second reversals should both depend on the structure of the grain. I could not obtain a third reversal with a photobromide containing 0.1 percent Ag even after exposing all day.

"For the sake of completeness it should be mentioned here that photobromide films with very little silver, 0.05 percent Ag for instance, show the phenomenon on primary physical development which has already been described for the plates with 0.4 percent Ag. Reversed images are formed but the precipitation of nascent silver takes place very slowly and the exposed portions take up but little silver.

<sup>1</sup> Lüppo-Cramer: *Photographische Probleme*, 156 (1907).

"Even though the extraordinary tendency of photo-bromide emulsions to solarization is not due to the incorporated silver alone but is due in part to the special structure of the grain,<sup>1</sup> check experiments showed that the silver nucleus causes the first reversal to take place with a much shorter exposure. The gold nucleus has no action of this sort. It is true that on longer exposure the films containing gold nuclei give a distinctly reversed image when developed; but this is evidently nothing more than the ordinary solarization of the silver bromide itself which is not prevented by the gold nuclei."

One of the objections to considering the latent image as a photohalide is that we do not get bright pink plates when we expose a dry plate to light. This objection has recently been discussed by Lüppo-Cramer<sup>2</sup> who admits that "the question might be raised whether it would not be possible to obtain the scale of colors by exposing the silver halides to white light, varying merely the intensity or the time of exposure. Regular photographic practice shows that this is generally not the case. On printing-out paper one never observes either a yellow or an orange-colored silver nor do we get marked differences in color in the different tones of a print. With ordinary silver bromide films there is even less of any definite color to be seen. It is possible that the speed of reduction might be the reason why, with silver chloride, they form at once the largest particles of silver which are possible in view of the size of the silver chloride grains. With most silver bromide films, the absence of any vivid color as a result of the direct photochemical decomposition is due chiefly to the fact that these emulsions contain grains of very different

<sup>1</sup> Microscopic examination showed that the single grains of the silver bromide gel plates are agglomerated in a curious way to larger groups. This agglomeration of the grains may also account for the fact that the surface of these films is much rougher than that of the Schleussner transparency plate, the grains of which were not much finer than the single grains of the silver bromide gel film.

<sup>2</sup> *Phot. Correspondenz*, 48, 353 (1911).

sizes.<sup>1</sup> Even if some of the grains tended to give bright colors, this difference in size would keep such an effect from being noticeable because very impure colors would result from the photochemical decomposition of the grains of such different sizes.

"Now I found, when studying the development by light of the latent images produced by Röntgen rays, radium rays and ultraviolet light,<sup>2</sup> that certain fine-grained silver bromide films (Schleussner transparency plates), after disintegration by these forms of energy, developed a rather bright pink color when decomposed more by light. When exposed to light in presence of halogen adsorbers, these films gave sometimes quite distinct colors. Microscopical investigation showed that the grain was fairly uniform.

"I obtained extraordinarily interesting preparations by bathing these plates in a 2 percent silver nitrate solution and then drying. If these plates are exposed under the Chapman Jones plate tester to sunlight for 1-2 hours, or for a correspondingly longer time (1-2 days) to bright, diffused daylight, one sees an intensely blue-black color spread uniformly over all the twenty-five spaces.<sup>3</sup> The slight tinge of blue in the photochemical blackening does not prepare one at all for the beautiful effect which appears when the plate is fixed in hyposulphite or ammonia. In the fields corresponding to the least exposure the plate is a pure yellow, which changes as one passes along the rows through orange and red to violet and blue. The colors are so pure and beautiful that I recommend this very simple experiment to all lovers of a beautiful experiment. This color scale shows in its course a complete agreement with the color scale of colloidal silver obtained by my nucleus method<sup>4</sup> or by successive intensification of

<sup>1</sup> Phot. Correspondenz, 47, 576 (1910).

<sup>2</sup> Lüppo-Cramer: Die Röntgenographie, 29 (1909).

<sup>3</sup> Just as with the silver chloride printing papers, one notices the familiar phenomenon of a solarizing reversal, which even reaches the second stage if the exposure has been very long. This anomaly disappears when the plates are fixed.

<sup>4</sup> Phot. Correspondenz, 47, 337, 527 (1910).



microns. The colors show only by transmitted light. By reflected light one sees only the bright, reflecting silver. One does not get in this way the depth of color which one gets in the previously described methods of preparing colored silver, by purely chemical methods.

"This photochemical method brings out clearly what one really ought to have expected from what is already known about colored silver. When the silver formed by exposure in silver bromide is laid bare by fixing the plate, the colors appears in the usual order, which shows that, with increasing exposure to light, the particles grow from yellow to red and blue. This growth takes place fairly slowly in the case of silver bromide and possibly more uniformly and more effectively.<sup>1</sup> I have not been able to obtain similar results with any silver chloride preparation.

"The formation of the silver evidently takes place on the surface of the silver bromide grains for oxidizing agents destroy nearly all traces of the direct photochemical blackening. In connection with this I should like to refer to a former paper,<sup>2</sup> in which I showed that yellow and reddish tones can be obtained with these silver bromide emulsions by suitable development whereby the silver apparently separates only on the surface of the grain.

"It is worth noting that no trace of color is to be seen, before fixing, on the silver bromide films containing silver nitrate. These plates therefore differ strikingly from the films of the old polychromy where the great difficulty was that the colors could not be fixed. When the bluish black

---

<sup>1</sup>I have assumed that here, as in many cases, the speed of the photochemical reduction has an effect on the degree of dispersity of the silver. In favor of this point of view is the fact that all changes in the sensitizing bath, which increases the rate at which halogen is removed, prevent the formation of the different colors on the silver bromide films containing silver nitrate. The addition of citric acid, the conversion of the silver salt into ammoniacal silver oxide, even the increase of the silver nitrate concentration to 10 percent, prevent the formation of the color scale; only uniformly brownish or reddish colored images being formed.

<sup>2</sup>Atelier des Photographen, No. 8 (1908).

silver is fixed, there is probably a peptonizing disintegration of the silver similar to that observed when Röntgen ray latent images are developed by light.<sup>1</sup> A similar change in the dispersity of silver was also noticed by W. Reinders when his crystallized photochlorides dissolved in ammonia containing gelatine; the blue photochloride gave red silver and the red photochloride yellow silver."

We are now ready to discuss the theory of the latent image from a single point of view. This will be done in the next paper.

*Cornell University*

<sup>1</sup> Lüppo-Cramer: *Die Röntgenographie*, 29 (1909).

## COLLOIDAL FERRIC OXIDE

BY G. D. KRATZ

L. T. Wright<sup>1</sup> has given a rather surprising method of preparing colloidal solutions of ferric oxide.

"Ferric chloride solution was added slowly to excess of liquid ammonia, with constant stirring. This operation was effected in a porcelain evaporating dish, which was then placed in a water bath, and its contents evaporated to dryness. By this means, a dirty red-brown mass was obtained, showing here and there patches of ammonium chloride. This mass, on being treated with water, fell mostly into an impalpable powder, a large portion of which, on attempted filtration, passed through the filter paper and even through many successive filters. The filtrates were of bright red color, and when dilute, had in certain lights a purple appearance, suggestive of the purple color of ignited ferric oxide. Each filtrate, on being boiled and refiltered, left on the paper a small quantity of red hydrated ferric oxide, but the filtrate was still red. Portions of these red filtrates, which all had an acid reaction, on treatment with a little ammonia to alkaline reaction and boiling, partially coagulated and left decided quantities of bright red powder on the filter, but the filtrates were still red, not having the appearance of solutions, being muddy and opaque, with what appeared to be an unfilterable precipitate. This is probably similar to the material called "colloidal ferric hydrate," "dialyzed iron," or "fer Bravais." Magnier de la Source<sup>2</sup> in describing a similar condition of ferric hydrate, or compound of ferric hydrate and ferric chloride, supposes that under certain conditions ferric hydrate is soluble in water; but I cannot think that this is a case of true solution, but rather of "pseudo" solution; for the filtrates I obtained had all the appearance of holding in suspension an intensely impalpable powder. They deposited

<sup>1</sup> Jour. Chem. Soc., 43, 156 (1883).

<sup>2</sup> Comptes rendus, 90, 1352 (1880).

small quantities of red powder on standing for some weeks, and in cases where they had been treated with ammonia and boiled to neutrality, they exhibited after long standing an acid reaction. Now, however, a drop of liquid ammonia and the application of a little heat, caused the pseudo solution to coagulate in light red flocks, which speedily settling, left the supernatant liquor perfectly bright and clear. I have made some further observations which may explain the presence of basic salt in the ferric hydrate prepared in presence of ammonium chloride, and on the difficulty of preparing ferric hydrate free from basic salt.

"Some ferric hydrate washed, dried at 100°, rewashed and redried at 100°, lost on ignition

- (1) 11.49 percent..... $\text{Fe}_2\text{O}_3\cdot\text{H}_2\text{O}$   
 (2) 11.32 percent.....10.11 percent.

"One gram of this hydrated ferric oxide boiled with about 100 cc of pure water in a retort, gave a distillate quite neutral to litmus.

"Five grams  $\text{NH}_4\text{Cl}$  in 100 cc pure water on boiling gave a weak acid distillate. On pouring the ammonium chloride solution into the retort containing the hydrated ferric oxide, and distilling to dryness, free ammonia equal to 0.005 gram was obtained. On repeating this experiment many times, I always obtained an alkaline distillate containing an appreciable quantity of ammonia, the action

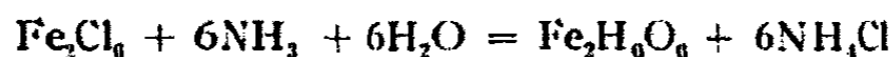

being apparently reversed

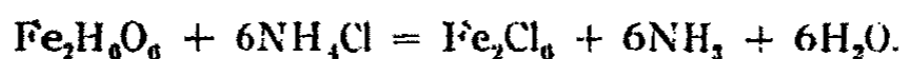

"Having prepared numerous samples of hydrated ferric oxide by means of  $\text{Fe}_2\text{Cl}_6$  and  $\text{NH}_3$ , I have noticed that they all possess different shades of color, no two samples having exactly the same shade of red. They range in color from dirty brown to bright brick-red. D. Tommasi<sup>1</sup> divides ferric hydrate into two classes: red, obtained by precipitating a

<sup>1</sup> Bull. Soc. chim. Paris, [2] 38, 152 (1882).

ferric salt with alkalis, and yellow, by oxidation of ferrous hydrate, ferrosferric hydrate, or ferrous carbonate; but<sup>1</sup> he has found that ferric hydrate kept under water for a year is converted to the extent of 0.3 percent into a soluble modification identical with Graham's "colloidal hydrate." I am inclined to think that this ferric hydrate was slightly impure, and that the color differences and the formation of a small quantity of "colloidal hydrate" are due to contained basic salt."

As it was not at all clear how this method of making colloidal ferric oxide was to be classified. Professor Bancroft suggested that I repeat Wright's work so as to find out just what happened. The first attempts resulted in complete failures. I added 10 cc of a 10 percent  $\text{FeCl}_3$  solution to 300 cc concentrated  $\text{NH}_4\text{OH}$  and evaporated to dryness in a porcelain dish on the water bath, and I repeated this adding the ferric chloride solution to 200 cc concentrated  $\text{NH}_4\text{OH}$ , so as not to have so large an excess of ammonia. The residue answered Wright's description of being "a dirty red-brown mass, showing here and there patches of ammonium chloride." When treated with water, the mass did not fall to an impalpable powder and did not pass through the filter paper. In fact the substance appeared to be quite insoluble in water and was so hard that it could not readily be ground to a powder.

These experiments showed that Wright had not given full and clear directions as to his process. It was at first thought that the evaporation had been carried too far and that the ferric oxide had thereby been made insoluble. To test this hypothesis I went to the other extreme, adding 5 cc of a 10 percent  $\text{FeCl}_3$  solution to 300 cc concentrated  $\text{NH}_4\text{OH}$  and evaporating to about 100 cc. The precipitate thus obtained was not soluble in water.

After puzzling over the matter for some time, it seemed probable that Wright had evaporated to dryness on a water

<sup>1</sup> Bull. Soc. chim. Paris, [2] 37, 196 (1882).

bath and had then washed all the ammonium chloride out of the precipitate on a filter with boiling water. As the last traces of the ammonium chloride disappeared, the ferric oxide might peptonize and run through the filter. This guess proved to be correct.

I added 10 cc of a 10 percent  $\text{FeCl}_3$  solution to 200 cc concentrated ammonia in a porcelain dish and evaporated to dryness on a water bath. The resultant dark brown mass was placed on a filter and washed with boiling water to remove the ammonium chloride. As the ammonium chloride disappeared, the ferric oxide ran through the filter as a dark or bright red suspension, just as Wright describes, though none of my suspensions were as bright red as I should judge Wright's to have been.

There is another source of error to which Wright makes no reference. In one case the ferric chloride solution was run into the ammonia solution as usual; but the mixture was not evaporated at once. It was poured into a beaker and forgotten for about a week. At the end of this time, the contents of the beaker were poured into a porcelain dish and evaporated as usual. When the ammonium chloride was washed out, no colloidal ferric oxide was formed. This might be due to the solution having stood for so long or it might be a result of some of the ammonia having evaporated. In order to distinguish between these alternatives, I made up two solutions as before and placed one in a stoppered Erlenmeyer flask and the other in an unstoppered flask. Both flasks were set aside for a week and then the contents were evaporated and treated in the usual manner. No ferric oxide ran through the filter in either case even though I washed each precipitate with 500 cc boiling water.

This proves that standing will cause ferric oxide to become insoluble, presumably as a result of agglomeration. The evaporation of the ammonia does have an effect on the quality of the evaporated residue. From the flask that had been uncorked I obtained a gritty, lumpy, residue which did not stick to the filter. From the flask that had stood corked,

I obtained a fine, soft powder which tended to stick to the filter paper.

Debray<sup>1</sup> pointed out that colloidal ferric oxide is precipitated by sodium chloride and that it redissolves if the salt is washed out at once. In Wright's experiments we have ammonium chloride as the precipitating agent and the ferric oxide peptonizes when the concentration of the coagulating substance is made sufficiently small. The method of Wright is not to be recommended as a means of getting a concentrated solution; but it eliminates dialysis and the necessity of washing a gelatinous precipitate. It is evident that Wright had profited by Chautard's statement<sup>2</sup> ten years earlier that when a gelatinous precipitate is to be washed, much time may be saved by adding an excess of the precipitant, and evaporating the whole until a dry powder is obtained, which can then be readily washed on the filter.

This work was suggested by Professor Bancroft and has been carried on under the supervision of Mr. T. R. Briggs. The general results of the paper are as follows:

(1) Wright's method of making colloidal ferric oxide is based on the washing out of the coagulating agent, ammonium chloride.

(2) If the mixed solutions of ferric chloride and ammonia are allowed to stand for a week before being evaporated, no colloidal ferric oxide is obtained. This is the result of spontaneous changes in the gel.

(3) Wright's method does not give a very concentrated solution but it avoids the necessity of dialysis or of washing a gelatinous precipitate.

*Cornell University*

<sup>1</sup> Comptes rendus, 68, 913 (1869).

<sup>2</sup> Chautard: Zeit. anal. Chem., 11, 299 (1873).

## THE REDUCTION OF NITROBENZENE BY MEANS OF FERROUS HYDROXIDE

BY HERMAN CAMP ALLEN

### General

While an enormous amount of work has been done on the reduction of nitrobenzene and its homologues by chemical and electrolytic methods, due to the purely scientific value of the subject and also to the technical importance of the reduction products in the manufacture of the various aniline dyes, etc., by far the greater part of the work, particularly along the line of pure chemical reduction, has been done with the idea of obtaining a maximum yield of some single substance and the reduction products present in less quantity have been regarded as impurities, in a sense, and their presence simply noted without determining in detail the factors upon which it depended. With this object in view, when a reducing medium showed its inapplicability to the production of certain compounds it has been discarded and some other chosen that would give a better yield of the desired compound. This is no doubt due in large measure to the analytical difficulties that are met with in working with these mixtures.

The result of all the work is usually briefly summed up in the general statement that reduction of nitrobenzene in acid solution leads to aniline and in neutral solution yields phenylhydroxylamine while the different alkaline reducing agents will give rise to the various intermediate products: azo-, azoxy- and hydrazobenzene. However, the fact must not be overlooked that in nearly every case the resulting product is not a single substance but a mixture of quite numerous reduction and many times complex decomposition products. Only in the case of aniline is it a comparatively simple matter to get a theoretical yield from the nitrobenzene and this may be readily accomplished in either acid or alkaline



solution by use of the proper reducing agents and working under suitable conditions.

#### Object

The following study was undertaken with a view to determining the influence of the various factors in the formation of the different intermediate reduction products of nitrobenzene as well as the formation of aniline when the reduction was accomplished by chemical means, and in general by the use of the same reducing agent ( $\text{Fe}(\text{OH})_2$ ). To this end the conditions as to method of addition, excess of reducing agent, concentration, temperature, etc., were varied systematically and a complete analysis made of the products formed when they were present in quantities which warranted such analysis.

From the knowledge gained of these conditions it was hoped to better correlate the formation of the different products when obtained by pure chemical reduction and when formed by the reducing action brought about by the passage of an electric current through a solution or suspension of nitrobenzene. While it is comparatively easy to obtain good yields of azobenzene in the electrolytic way<sup>1</sup> its production by pure chemical means is not so simple, and on the other hand, azoxybenzene may be readily prepared by chemical reduction<sup>2</sup> but is obtained in the electrolytic way only by a rather careful regulation of conditions.<sup>3</sup>

More data were also desired relative to the reducing power of a few substances, as measured by the products of reduction, and the single electrolytic potential of these substances taken with a platinized platinum electrode against a standard electrode. For details and tables see Bancroft<sup>4</sup> and Neumann.<sup>5</sup>

#### Apparatus

While the apparatus was modified somewhat during the

---

<sup>1</sup> Elbs and Kopp: *Zeit. Elektrochemie*, 5, 108 (1898).

<sup>2</sup> *Ber. chem. Ges. Berlin*, 28, R125 (1895); *Jour. prakt. Chem.*, [2] 50, 564 (1894).

<sup>3</sup> *Chem. Zeit.*, 17, 210. Haber: *Zeit. Elektrochemie*, 4, 506 (1898).

<sup>4</sup> *Zeit. phys. Chem.*, 10, 387 (1892); 14, 228 (1894).

<sup>5</sup> *Ibid.*, 14, 229 (1894).

course of the work the final and most satisfactory arrangement consisted of a 500 cc balloon flask with a rather wide mouth through the cork stopper of which were bored four holes. One of these contained a Liebig condenser and the stirring device passed through another. The third contained a glass rod which dipped into the solution in the flask and was bent to serve as a break and secure a maximum agitation of the liquid by preventing the solution from whirling around in the flask with the stirrer.

The fourth hole contained the tube for the introduction of the liquid to be added. This tube consisted of a funnel tube drawn down to rather a fine point to secure the smallest possible drops and inserted through the cork. A separatory funnel was connected by means of a cork to the bulb of the funnel tube and the liquid added from this. By this means the rate at which the liquid was dropping could be seen in the bulb of the funnel tube and regulated accordingly, while by introducing the separatory funnel directly through the larger cork and into the flask this could not be done as the walls of the flask soon become covered with the precipitate formed, thus making it impossible to see the interior.

The stirrer was of glass of the ordinary "screw propeller" type with two blades and was about 2 cm across, this being as large as could be introduced through the neck of the flask. Instead of a mercury seal a glass tube bearing, about 15 cm long was used and this effectively prevented the escape of any of the substances. The stirrer was direct connected to a small motor which could be driven by a storage battery with a resistance in series or on the 110 volt D. C. circuit with lamps in series. The speed could be regulated to a nicety up to anything below 1500 r. p. m. The stirring served the double purpose of agitating the mixture and bringing the various portions in intimate contact with each other at the lower temperatures and prevented the troublesome bumping when the runs were made at the boiling temperature and needed no additional stirring.

In connection with the Liebig condenser an air condenser

about one meter long was used to prevent the possible escape of the nitrobenzene or the reduction products and on the end of the air condenser a Bunsen valve was placed to prevent circulation of the air and oxidation by this means. A few runs were made with the air in the flask displaced with illuminating gas but showed no difference in results so it was decided that no appreciable oxidation was caused by the air already in the flask and this method was abandoned.

The complete apparatus was mounted on a single stand which made everything firm and convenient for manipulation.

#### **Solutions, Etc.**

The ordinary C. P. chemicals were used in all the runs and for all the analytical operations.

The NaOH solution was made up 400 grams NaOH (81.5 percent) per liter and measured portions of this solution taken for each run.

The ferrous sulfate was weighed out and dissolved in the given amount of water, fresh for each determination as it would oxidize if made up in quantity.

The nitrobenzene was redistilled occasionally and only the intermediate portions, showing a boiling point of 207°–208° used in the trials.

The aniline used for standardizing the  $\text{KBrO}_3$  solution and for checks was freshly distilled and weighed out by difference for each determination, however, a solution of aniline in water containing 3 percent sulfuric acid was kept for three months and at the end of that time showed the same titer as a freshly prepared solution.

The benzene used in extracting was kept standing over sulfuric acid to insure its being free from aniline. It may be used repeatedly with very little loss; however, after the first use it will contain traces of the reduction products which will show easily with concentrated sulfuric acid and it may even be slightly colored from traces of azobenzene.

A few runs were extracted with ether but the benzene seemed to be equally efficient, easier to handle and a much

greater percent could be recovered so the ether was discarded in all the later runs in favor of the benzene.

### Manipulation

The general scheme was to reduce nitrobenzene by means of a ferrous sulfate solution made alkaline with NaOH. The three general methods of procedure were as follows and in the subsequent discussion will be referred to as Methods 1, 2 and 3.

(1) The nitrobenzene was run into a mixture of solutions of  $\text{FeSO}_4$  and NaOH. Since the iron immediately precipitates out as  $\text{Fe}(\text{OH})_2$ , which is the real reducing agent as ferrous sulfate alone will not reduce nitrobenzene, and as an excess of NaOH was used in all cases except a few which are noted, the general condition here is evidently an excess of reducing agent in a slightly alkaline solution.

(2) The NaOH was introduced into a mixture of ferrous sulfate in solution and nitrobenzene under which conditions the reduction may be supposed to be taking place in a nearly neutral solution with a comparatively small amount of the real reducing agent present.

(3) In the third method the ferrous sulfate was added to the NaOH and nitrobenzene contained in the flask and as the NaOH was quite concentrated the solution in which the reduction is taking place is very strongly alkaline and the reducing agent present in small amount.

After the addition of the third substance the regular method was to continue the stirring for about 30 minutes at the same temperature and then add about 75 cc benzene and stir for about 15 minutes longer. The liquid layers will not separate, due to the peculiar precipitate, and it is necessary to filter this off before they can be separated. The filtering was done on a Buchner funnel with suction and by decanting as much of the supernatant liquid as possible can generally be done quite rapidly though an occasional run will filter very slowly. The precipitate was then washed in the funnel twice with about 25 cc benzene which was

thoroughly mixed with the precipitate each time and then drawn through into the main filtrate. Tests made on the precipitate showed that very little of the reduction products remained after this treatment.

After filtering, the benzene and water layers were easily separated and the filtrate was given two more extractions with about 50 cc benzene each time and these extractions were added to the first benzene extract making a total of about 200 cc.

A number of the filtrates were steam distilled after separating to determine the amount of aniline left unextracted by this treatment and in no case was it found to exceed 1 percent of the total aniline.

#### **Analytical**

Methods for the quantitative analysis of a mixture of hydrazo-, azo-, azoxy- and nitrobenzene and aniline for all the substances when present in the same solution are not given in the literature and it was necessary to work out a scheme for doing this. The difficulty of the analysis is increased because of the mutual solubility of the substances in each other and their like solubilities in the ordinary organic solvents, while their similarity in chemical properties makes it difficult if not impossible with some of the substances to transform them separately and quantitatively into substances which are easily analyzed for.

The method worked out by Snowdon<sup>1</sup> of using the melting point for determining the composition of a mixture of azo- and azoxybenzene would not do in this case because of the impossibility of getting these constituents out of the mixture in even approximately pure condition and very slight impurities would invalidate results. Recrystallizing from alcohol seemed to be a hopeless task when dealing with small quantities, and repeated attempts at steam distillation in acid, neutral and alkaline solution led to the conclusion that it is impossible to separate nitrobenzene from azo- or azoxy-

<sup>1</sup> Jour. Phys. Chem., 15, 841 (1911).

benzene in more than a rough quantitative way by these methods and they were abandoned.

The following method was finally used in the analysis and while it is not as accurate as could be desired, seems to give fair results. It is believed that the errors for the different substances are fairly represented in the analysis of the known mixture given below.<sup>1</sup>

	Taken	Found	Method
Aniline	0.270	0.270	titration
Hydrazobenzene	0.133	0.141	difference
Azobenzene	0.312	0.318	colorimeter
Azoxybenzene	0.209	0.196	difference
Nitrobenzene	0.210	0.206	red-aniline

*Determination of Aniline.*—The benzene extract from the solution that had been reduced was divided into three equal parts. The aniline in one of these parts was shaken out with a very dilute solution of sulfuric acid. About three times the amount of acid called for on the basis of all the nitrobenzene having been reduced to aniline was made up to 150 cc and this used in making three extractions of the benzene solution. This was found to be sufficient to abstract the aniline to a point where the residue did not give a trace of color with a bleaching powder solution and the other reduction products were not affected.

The aniline in the sulfuric acid extract was then determined by the bromate method. The sulfuric acid extract was made up to a definite volume and a fraction of this taken that it was estimated would contain from 0.15–0.25 gram of aniline. Frequently the entire extract was used. About 50 cc of dilute (three parts water and one part concentrated sulfuric acid) sulfuric acid was then added and a solution of potassium bromide sufficient to ensure an excess. A standard solution of potassium bromate was then run in until the

<sup>1</sup> Analysis of known sample. For determination of hydrazobenzene see Curves No. V and No. VI.

yellow color due to the liberated bromine was visible. A few pieces of solid potassium iodide were next added and a little starch solution after which the free iodine was titrated back with a standard sodium thiosulfate solution.

The tribromaniline is readily formed at room temperature and the method is a very satisfactory one for the determination of aniline. While no special care was used in these determinations the variations in duplicates was seldom more than 0.3 percent.

The results are not affected by traces of azo-, azoxybenzene, benzene or benzidine but traces of hydrazobenzene will probably give high results. It is much more satisfactory when acid is added in considerable excess and a decided excess of potassium bromide and iodide should be used when working with unknown mixtures in order to ensure the best results.

*Total Residue Less Aniline.*—To determine the total residue after the removal of the aniline the above one-third was transferred to a 500 cc balloon flask and the greater portion of the benzene distilled off on the water bath. A Vigreux column 20 cm in length was used and a condenser and in this way the greater part of the benzene was recovered. It is necessary to distil the benzene off as given and quite cautiously or very material quantities of the other products will be carried over. The residue in the balloon flask was next transferred to an evaporating dish and the flask washed out with a few cubic centimeters of benzene after which the material in the evaporating dish, consisting of from 15–20 cc was evaporated down carefully on the water bath until about 2 grams of the mixture remained in the dish. At this point a series of five or six weighings were made at definite intervals of 3 or 5 minutes heating on a constant-level water bath and with all conditions such as height of flame, air currents, etc., as near constant as possible. A curve plotted between time and weight under these conditions shows a well defined break at the place where the benzene is all expelled and a point of maximum curvature may be chosen which represents the total weight of nitrobenzene

and reduction products with the exception of aniline in the sample used. For location of this point see Curves No. I-VI.

There is considerable tendency for the substances to "creep" during the evaporation, especially if heated too rapidly and a modification of the method, used when there was no hurry for results, consisted in allowing the benzene to evaporate at room temperature and weigh about every hour at the proper time to get the break in the curve. The evaporating dishes were kept in small desiccators and covered when the temperature of the room was abnormal or over night and no trouble was experienced in getting smooth curves.

*Determination of Azobenzene.*—A second one-third of the original benzene extract was then shaken out with dilute sulfuric acid (3-1), which removes both the aniline and hydrazobenzene.

After removing the aniline and hydrazobenzene in this portion the azobenzene was determined by comparing with a known solution in a Woulff colorimeter. A fresh, known solution of azobenzene in benzene was made up for each set of tests though very little change of color was noticed in a solution that had stood for several weeks as compared with a fresh solution. After a rough determination the known and unknown were made to about the same concentration and the average of several readings taken as representing the true value. The extreme variations in these readings were seldom more than 3 percent and while the color of other substances in the unknown no doubt interfered to some extent it is believed that the values found are not far from correct. In some cases there was a reddish coloration in the solution not due to azobenzene but probably due to phenylhydroxylamine, which shook out with the sulfuric acid, hence the use of this portion rather than the first for the determination of the azobenzene.

*Determination of Hydrazobenzene.*—After the determination of the azobenzene the solution is evaporated in the same manner as the first, transferred to an evaporating dish and



further evaporated with weighings, and a curve plotted between time and weight as above. From this curve and the one obtained from the first portion the hydrazobenzene is obtained by difference.

By shaking with sulfuric acid of the above strength the hydrazobenzene is converted into benzidine and diphenylene and precipitates out or goes into solution in the sulfuric acid solution, while the azo-, azoxy- and nitrobenzene are not affected. It is necessary to shake quite vigorously and with a considerable volume of the acid in order to ensure the complete removal of the hydrazobenzene. A volume of sulfuric acid about equal to the volume of the benzene solution was used in each case and a single thorough shaking was found to be sufficient to remove practically all the hydrazobenzene. The quantity of hydrazobenzene present appears to be much larger than it really is due to the fact that the precipitate does not separate out but remains distributed through the solution and with the higher concentrations gives it somewhat the consistency of a jelly. It is possible to filter the entire mass through a tared filter at this point, dry in the water oven and from the weight thus obtained get a very good idea of the hydrazobenzene present in a very short time.<sup>1</sup>

*Determination of Nitrobenzene.*—The nitrobenzene was determined by shaking the aniline and hydrazobenzene from the remaining one-third of the benzene extract with dilute sulfuric acid and transferring the benzene solution to a 500 cc balloon flask. The benzene was evaporated on the water bath as above after which a solution of ferrous sulfate was added to the flask and the whole made decidedly alkaline with NaOH. A large excess of the reducing agent was used and the mixture stirred at room temperature for about 30 minutes, extracted with benzene, filtered, separated, the benzene solution extracted with dilute sulfuric acid and the aniline determined as described above.

<sup>1</sup> Haber converts the hydrazo to benzidine by boiling with concentrated HCl, extracting the other substances with ether, making acid solution alkaline, extracting benzidine with ether and obtaining benzidine (Haber and Schmidt: *Zeit. phys. Chem.*, **32**, 274 (1900)).

Under these conditions and with an excess of 4 or 5 times the amount of reducing agent present required by theory to reduce everything to aniline the azo- and azoxybenzene are not reduced to aniline while the nitrobenzene is reduced quantitatively to aniline. While it would be much easier to distil with steam to remove the aniline from the mixture than to extract with benzene and filter at this point, the process of heating and steam distilling in the presence of an excess of reducing agent converts azo- and azoxybenzene partially to aniline and consequently spoils the determination.

*Determination of Azoxybenzene.*—The azoxybenzene was determined by difference; from the total residue, less aniline, as found in the first one-third of benzene extract less the other substances contained in the benzene extract as determined.

An effort was made to determine the azoxybenzene directly by shaking a portion of the benzene extract with concentrated sulfuric acid and comparing the red color produced with a standard, prepared at the same time, in a Krüss polarizing colorimeter. While checks made on different solutions of azoxybenzene were very satisfactory, even in the presence of azo- and hydrazobenzene, it was found that the greenish to brown coloration produced by nitrobenzene under these conditions interfered, even when the nitrobenzene was present in very small quantity and the method was given up. However, the test is a very valuable one in a qualitative way and a rough idea of the quantity of azoxybenzene present may also be obtained from the intensity of the red coloration and its rapidity of formation.

The above scheme of analysis is the one followed when all the substances were present; however, a little preliminary testing for aniline with bleaching solution, hydrazobenzene with dilute sulfuric acid and azoxybenzene with concentrated sulfuric acid and the red coloration in the original benzene extract due to azobenzene furnish an indication of the substances really present and the method may be modified accordingly.

Phenylhydroxylamine could doubtless be estimated in

this mixture by taking advantage of its insolubility in petroleum ether or ligroin<sup>1</sup> but as it occurred only in traces no effort was made to determine it quantitatively in this work.

#### Summary of Analysis

Divide benzene extract in three equal portions.

(1) Shake aniline from one part with very dilute sulfuric acid and determine by bromate method.

(2) Evaporate benzene from this and determine total residue less aniline by break in time-weight curve.

(3) Shake out a second part of benzene extract with dilute sulfuric acid which removes both hydrazobenzene and aniline.

(4) Determine azobenzene in this portion by use of colorimeter.

(5) Evaporate benzene from this and get residue less aniline and hydrazobenzene which is determined from 2 and 5.

(6) Shake out third portion with dilute sulfuric acid evaporate benzene and reduce nitrobenzene to aniline and determine aniline as in 1. Calculate nitrobenzene.

(7) Determine azoxybenzene by difference.

#### Curves

A few curves on known solutions, made as described above, are introduced to show their general character and the impossibility of correctly determining the residue by simply evaporating the benzene and making a single weighing. It was hoped to find two breaks in these curves, the first of which would fix the point when all the benzene was evaporated and the second where the nitrobenzene had been driven off. A study of the curves will show how near this was realized.

Curve I.—With a comparatively large amount of nitrobenzene and a small quantity of azobenzene two breaks are clearly shown. The break at (A) corresponds to the total weight of substance in solution, the cross marking the weight of substance actually introduced. The second break at

<sup>1</sup> Haber: *Zeit. phys. Chem.*, 32, 274 (1900).

(B) however, does not represent the weight of azobenzene in the mixture as this falls at (C) considerably lower. After passing the point (B) the residue slowly lost weight with decomposition and after (C) had been passed failed to solidify. Efforts to use the point where the residue failed to solidify in a quantitative way failed, however, particularly in the case of more complex mixtures.

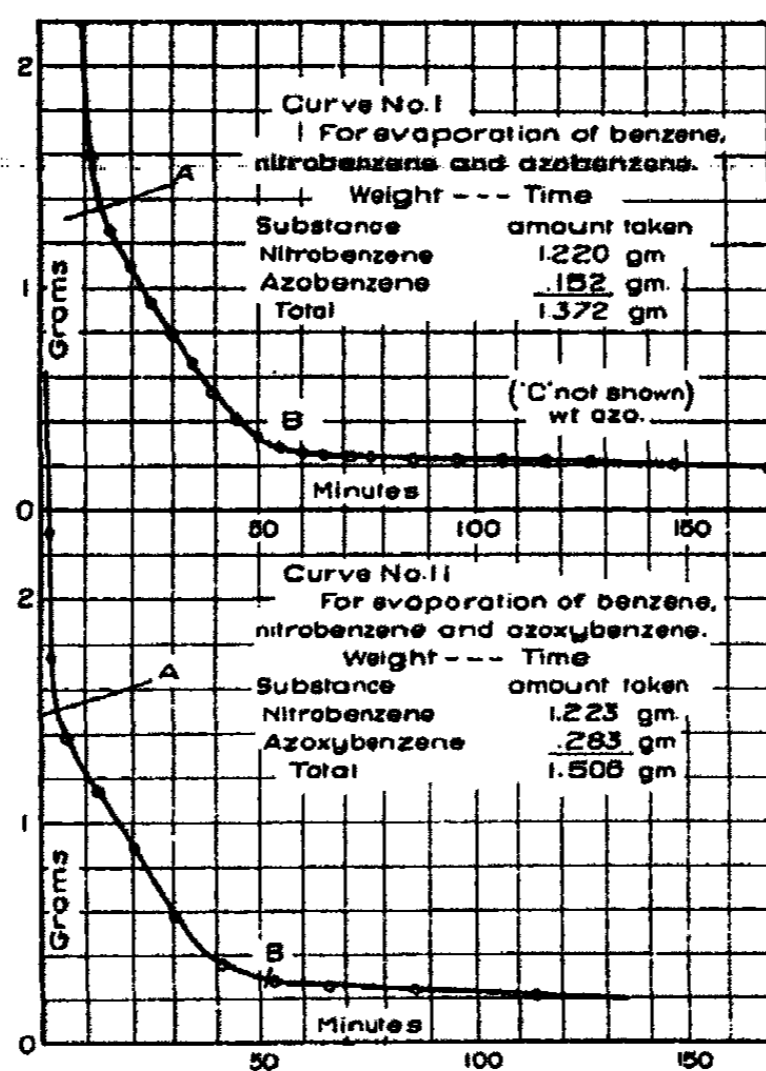

Curve II.—Under similar conditions, but with azoxybenzene and an excess of nitrobenzene the first point is sharp and the second break comes much nearer the weight of azoxybenzene actually present which falls at (B) on the curve.

Curve III.—Benzene with a comparatively large amount of azobenzene and small quantity of nitrobenzene.

Curve IV.—Benzene with azobenzene and nitrobenzene introduced in molecular proportions. This curve shows only one clear break and a slight bending of the lower part.

The cross at point (A) on all the curves shows the amount of substance dissolved in the benzene and indicates how near the total weight of the various mixtures may be estimated by choosing the point of greatest curvature on the curve.

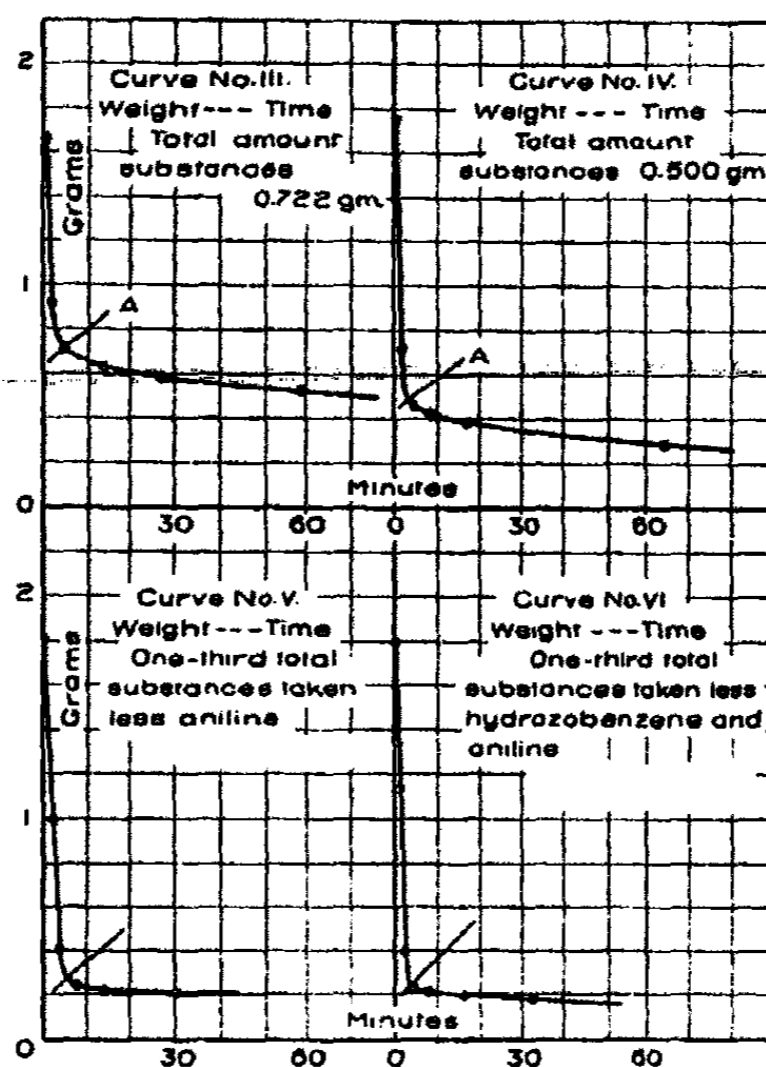

#### Tables, Etc.

While some of the earlier runs were made before the scheme for complete analysis had been worked out and were later duplicated, it is believed that they have considerable value as checks of later runs and for certain comparisons so the entire table is given, less a few results that were evidently valueless due to broken flasks, improper handling, etc. All results have been recalculated on a basis of 1.2 grams nitrobenzene though some of the earlier runs were made with 7.5 grams and others with 3 grams. In all the later runs the nitrobenzene was measured out with an approximately 1 cc pipette which a number of determinations showed would deliver 1.2 grams. While the use of this smaller

amount has certain evident disadvantages the character of the solutions make the use of larger quantities impractical.

Runs below No. 31 were made with a poor grade of ferrous sulfate and while comparable with each other are low when compared with later results. Below No. 21 the solutions were not stirred with a motor. The boiling runs received no additional stirring and those at temperatures below boiling were simply agitated by shaking the entire apparatus occasionally; those not stirred with a motor cannot be compared with the ones that were except at the boiling temperature when the ebullition and bumping produced considerable stirring.

While it was expected that the different methods would produce various reduction products due to differences in the alkalinity of the solution and relative excess of  $\text{Fe}(\text{OH})_2$  present, as stated under manipulation, a comparison of the results obtained (Table II) will show that this is hardly the case as regards the first two methods, for while the addition of the nitrobenzene to the two other substances probably gives on the whole, a little more aniline the difference is hardly enough to warrant a general statement to that effect and it may be said that the two first methods always yield aniline as the principal reduction product and yield it in practically equal amounts under like conditions.

This is probably due to the fact that the reduction takes place very rapidly and since the  $\text{FeSO}_4$  alone will not reduce the nitrobenzene and the  $\text{Fe}(\text{OH})_2$  formed is only slightly soluble the conditions in the two cases, as to alkalinity and active  $\text{Fe}(\text{OH})_2$  present, may be practically identical in the immediate vicinity of the drop added where the reduction is taking place. That the reduction does take place rapidly is clearly shown by Run No. 69 in which the stirring was continued for only 5 minutes after the addition of the nitrobenzene and upon extraction with benzene gave a yield of 100 percent aniline.

The failure to obtain intermediate products in the two first methods probably results from the fact that the nitroso-

TABLE Ia

Run No.	Method No.	Ferrous sulfate (anhydrous) g.	Water cc	Solid NaOH (81.5%) g.	Solution NaOH cc	Nitrobenzene g.	Temperature °C	Aniline Per-cent
7 <sup>1</sup>	1	12.6	60	8	20	1.2	B	73
15	2	12.6	60	8	20	1.2	B	73
9	3	12.6	60	8	20	1.2	B	58
10	1	12.6	60	8	20	1.2	75	75
11	2	12.6	60	8	20	1.2	75	72
13	3	12.6	60	8	20	1.2	75	57
12	1	12.6	60	8	20	1.2	55	42
14	2	12.6	60	8	20	1.2	55	43
17	3	12.6	60	8	20	1.2	55	33
21 <sup>2</sup>	1	22	60	16	20	1.2	B	74
20	3	22	60	16	20	1.2	B	73
25	1	12.6	60	8	20	1.2	B	72
23	2	12.6	60	8	20	1.2	B	76
24 <sup>3</sup>	2	12.6	60	2.4	12	1.2	B	18
26	3	12.6	60	8	20	1.2	B	33
27	3	12.6	60	6.5	16	1.2	B	34
28	3	12.6	60	4.8	12	1.2	B	31
29 <sup>3</sup>	3	12.6	60	3.2	8	1.2	B	17
30	3	12.6	80	8	20	1.2	B	30
31 <sup>4</sup>	3	7.6	80	8	20	1.2	B	16

B = Boiling temperature (102–103°). T = considerable; *l* = trace;

R = Room temperature (about 25°). *u* = undetermined;

A = All added together.

<sup>1</sup> A few of the first runs have been rearranged to facilitate comparison. All runs in Table Ia were made with 3 grams of nitrobenzene and corresponding quantities of the other substances. They have been recalculated to fit in with the other runs.

<sup>2</sup> All runs from here on were stirred with motor.

<sup>3</sup> No doubt considerable nitrobenzene in this.

<sup>4</sup> This was an exceptionally good run that did not contain much nitrobenzene but which could not be duplicated so far as low aniline yield.

TABLE Ib

Run No.	Method No.	Ferrous sulfate (anhydrous) g.	Water cc	Solid NaOH g.	Solution NaOH cc	Nitrobenzene g.	Temperature °C	Alcohol cc
33	3	6.6	80	8	20	1.2	B	0
34	1	8.8	60	8	20	1.2	B	0
36	3	7.7	80	8	20	1.2	R	0
37	3	6.6	80	8	20	1.2	B	25
38	2	12.6	60	8	20	1.2	R	0
39	3	7.7	80	8	20	1.2	R	0
40	3	7.7	80	8	20	1.2	55	0
41	3	7.7	80	8	20	1.2	75	0
42	3	7.7	80	8	20	1.2	R	0
43	1-2	11	80	12	30	1.2	B	28
44	1-2	11	80	6	15	1.2	B	28
45	1-2	11	80	4	10	1.2	B	28
46	1-3	5.5	80	8	20	1.2	B	30
47	3	7.7	80	8	20	1.2	O	0
48	3	9	80	8	20	1.2	B	0
49	1	11	80	8	20	1.2	B	25
53	1-2	16.4	80	12	30	1.2	B	27
54	1-2	16.4	80	12	30	1.2	B	27
57	3	11	80	20	25	1.2	B	0
59	2	12.6	60	8	20	1.2	B	0
60	1	12.6	60	8	20	1.2	B	0
61	1-2	16.4	100	8	20	1.2	R	50
62	1-2	16.4	100	8	20	1.2	R	50
63	1-2	16.4	100	8	20	1.2	R	50
64	1	12.6	60	8	20	1.2	R	0
65	2	12.6	60	8	20	1.2	R	0
66	3	12.6	60	8	20	1.2	R	0
67	1	12.6	60	8	20	1.2	R	0
68	1	12.6	60	8	20	1.2	R	0
69	1	12.6	60	8	20	1.2	R	0
70	A	12.6	60	8	20	1.2	R	0



Run No.	Method No.	Aniline Percent	Recovered				Total Percent
			Hydrazobenzene Percent	Azobenzene Percent	Azoxybenzene Percent	Nitrobenzene Percent	
33	3	29	1	19	27	1	75
34	1	75	T	T	"	"	"
36	3	52	4	1	38	..	94
37	3	31	3	21	35	..	90
38	2	76	T	1	20	..	96
39	3	45	5	5	35	..	90
40	3	25	6	45	1	18	94
41	3	21	T	41	28	..	91
42	3	60	3	12	6	..	81
43	1-2	98	O	1	"	"	98
44	1-2	92	O	1	4	..	96
45	1-2	25	T	T	"	"	"
46	1-3	69	2	14	4	..	89
47	3	39	1	1	28	23	90
48	3	23	7	60	T	1	91
49	1	84	O	1	1	9	93
53	1-2	93	"	"	"	"	"
54	1-2	94	"	"	"	"	"
57	3	35	T	49	T	"	"
59	2	82	T	1	O	1	84
60	1	82	1	1	O	1	83
61	1-2	99	"	"	"	"	"
62	1-2	101	"	"	"	"	"
63	1-2	108	"	"	"	"	"
64	1	99	O	1	O	"	"
65	2	95	"	"	"	"	"
66	3	53	T	T	42	..	95
67	1	81	"	"	"	"	"
68	1	94	O	O	1	T	"
69	1	100	"	"	"	"	"
70	A	99	"	"	"	"	"

<sup>1</sup> In runs where the percentages are given under azoxybenzene followed by (..) under nitrobenzene, the figures refer to the sum of azoxybenzene plus nitrobenzene, the two not having been determined separately.

33. Added  $\text{FeSO}_4$  solution very slowly.
34. Residue not determined.
36. Considerable nitrobenzene in residue. Compare 85, 87.
37. Apparently azobenzene in this as soon as reduced.
38. Low aniline yield. Compare 65.
39. Duplicate of 36.
40. Azobenzene not determined at once. May have come from hydrazobenzene.
42. No doubt azoxybenzene in residue.
43. Could not duplicate this run. Compare 53, 54. Enough alcohol was added in these runs to keep the nitrobenzene in solution in the NaOH and this mixture added to the  $\text{FeSO}_4$  solution.
46. Not enough iron to give products. Alcohol must reduce some.
47. Flask surrounded with ice water.
48. Azobenzene may have come from hydrazobenzene.
49. No explanation for presence of nitrobenzene.
53. Attempt to duplicate 43.
54. Same as 53.
57. Azobenzene may have come from hydrazobenzene.
59. Traces of other products.
60. Vaporized nitrobenzene into flask from small side flask.
61. Compare 64. No necessity for alcohol. Steam distilled.
62. Added 0.3 gram azoxybenzene to this. Steam distilled.
63. Added 0.3 gram each azo- and azoxybenzene. Steam distilled.
64. Practically theoretical yield easy at room temperatures.
65. Traces of other products.
66. Residue mostly azoxybenzene. Traces of other products.
67. No explanation for low yield aniline. Steam distilled.
68. Rather low yield.
69. Stirred 5 minutes after adding nitro. Extracted with benzene.
70. Added all together. Stirred 30 minutes. Steam distilled.

TABLE Ic

Run No.	Method No.	Ferrous sulfate (anhydrous) g.	Water No.	Solid NaOH g.	Solution NaOH cc	Nitrobenzene g.	Temperature °C
71	3	12.6	60	8	20	1.2	7
72	A	12.6	60	8	20	1.2	R
73	1	9.5	45	6	15	1.2	R
74	1	12.6	60	8	20	1.2	57
75	1	12.6	60	8	20	1.2	B
76	A	12.6	60	8	20	1.2	R
77	1	12.6	60	8	20	1.2	77
78	3	12.6	60	8	20	1.2	B
79	3	12.6	60	8	20	1.2	68
80	3	12.6	60	8	20	1.2	B
81	3	12.6	60	8	20	1.2	74
82	1	12.6	60	8	20	1.2	B
83	2	12.6	60	8	20	1.2	R
84	1	12.6	100	8	20	1.2	R
85	3	6.6	60	8	20	1.2	R
86	1	6.6	60	8	20	1.2	R
87	3	5.2	60	8	20	1.2	R
88	1	12.6	60	4	20	1.2	R
89	3	12.6	60	8	20	1.2	R
90	3	12.6	60	8	60	1.2	R
91	3	12.6	60	4	10	1.2	R
92	A	19	80	12	30	1.2	R
93	3	8.5	80	8	40	1.2	B
94	1	12.6	60	8	20	1.2	B
95	3	6.6	60	8	20	1.2	B
96	3	4.9	60	8	20	1.2	B
97	3	6.6	80	6	75	1.2	B
98	3	6.6	80	4	100	1.2	B
99	3	6.6	80	3	100	1.2	B

Run No.	Method No.	Aniline Percent	Recovered				Total Percent
			Hydrazobenzene Percent	Azobenzene Percent	Azoxybenzene Percent	Nitrobenzene Percent	
71	3	80	O	O	13	4	97
72	A	97	O	t	u	T	u
73	1	83	O	t	t	4	u
74	1	97	t	t	u	u	u
75	1	80	O	O	O	T	81
76	A	99	u	u	u	u	u
77	1	89	O	O	O	u	u
78	3	37	u	u	u	u	u
79	3	23	u	u	u	u	u
80	3	35	54	T	3	3	95
81	3	21	52	8	14	2	97
82	1	77	O	O	t	1	79
83	2	96	O	t	O	T	u
84	1	98	u	u	u	u	u
85	3	15	O	O	37	44	96
86	1	39	O	O	5	52	96
87	3	8	O	O	20	64	92
88	1	28	O	O	O	63	91
89	3	58	T	t	33	1	92
90	3	47	O	t	47	1	95
91	3	23	t	O	35	37	95
92	A	98	u	u	u	u	u
93	3	33	57	T	t	1	92
94	1	80	t	t	t	u	81
95	3	30	9	7	51	1	98
96	3	24	t	O	51	14	90
97	3	19	13	5	55	2	94
98	3	18	O	O	76	2	96
99	3	5	O	O	65	13	83

71. Nitro solid. All frozen at end of run. Traces other products.  
 72. No stirring; simply stood over night. Steam distilled.  
 73. Iron precipitate red. Steam distilled.  
 74. Compare with 12 which was not stirred.  
 75. Residue not found in boiling runs. Method 1 or 2.  
 76. All added together. Steam distilled.  
 77. Compare with 10 not stirred.

78. Aniline check on 80.  
 79. Aniline check on 81.  
 80. Characteristic run. Hydrazo determined at once.  
 81. Characteristic run. Hydrazo not determined at once.  
 82. Attempt to find residue failed.  
 83. Compare 65, 38.  
 84. Steam distilled. No effect from dilution.  
 85. Effect of reducing quantity of iron. 3.06 grams iron used.  
 86. Effect of reducing quantity of iron.  
 87. Effect of reducing quantity of iron.  
 88. Effect of reducing quantity of alkali.  
 89.  
 90. Diluting alkali; decrease aniline, increase azoxybenzene.  
 91. Diminishing alkali.  
 92. Added 0.3 gram each azo- and azoxy. Extracted benzene.  
 Compare 63.  
 93. Traces of other reduction products.  
 94. Unable to find residue.  
 95. Diminishing quantity Fe. 6.2 grams Fe to produce products.  
 96. Diminishing quantity Fe. Exactly all iron used up.  
 97. Diminish both iron and alkali.  
 98. Maximum amount of azoxy obtained. 5.12 grams iron used up.  
 99. As above. Nitro probably low.

TABLE II.<sup>1</sup>—METHODS

Run No.	Method No.	FeSO <sub>4</sub> (Anhyd.) g.	Water cc	NaOH solid g.	Solution cc	Nitrobenzene g.	Temperature °C	Aniline Percent	Hydrazobenzene Percent	Azobenzene Percent	Azoxybenzene Percent	Nitrobenzene Percent	Total Percent
64	1	12.6	60	8	20	1.2	R	99	O	1	O	"	"
65	2	12.6	60	8	20	1.2	R	95	"	"	"	"	"
89	3	12.6	60	8	20	1.2	R	58	T	1	33	1	92
60	1	12.6	60	8	20	1.2	B	82	T	1	O	1	84
59	2	12.6	60	8	20	1.2	B	82	1	1	O	1	83
70	A	12.6	60	8	20	1.2	R	99	"	"	"	"	"
76	A	12.6	60	8	20	1.2	R	99	"	"	"	"	"

(Compare also: 7, 15, 9; 10, 11, 13; 12, 14, 17; 23, 25; 86, 85).

<sup>1</sup>A few runs have been taken from Table I and rearranged under the different topics to facilitate comparison while other runs will simply be referred to by number and may be found in General Table I.

benzene formed is very unstable in this solution with the excess of reducing agent that must always be present and does not accumulate in sufficient amount to react with the hydrazobenzene but rather, is reduced to hydrazobenzene which may accumulate in considerable quantity and in turn be reduced to aniline or at the higher temperatures may be partially decomposed. (See temperature.)

If we accept the Haber scheme<sup>1</sup> for the reduction of nitrobenzene in acid or alkaline solution this would account for the absence of anything but traces of the intermediate products under the conditions that obtain in Methods 1 and 2.

<sup>1</sup> HABER'S SCHEME FOR REDUCTION OF NITROBENZENE.—A number of references are made to the scheme of reduction of nitrobenzene proposed by Haber<sup>2</sup> as it seemed to explain very well the results obtained and it is reproduced here with a brief explanation.

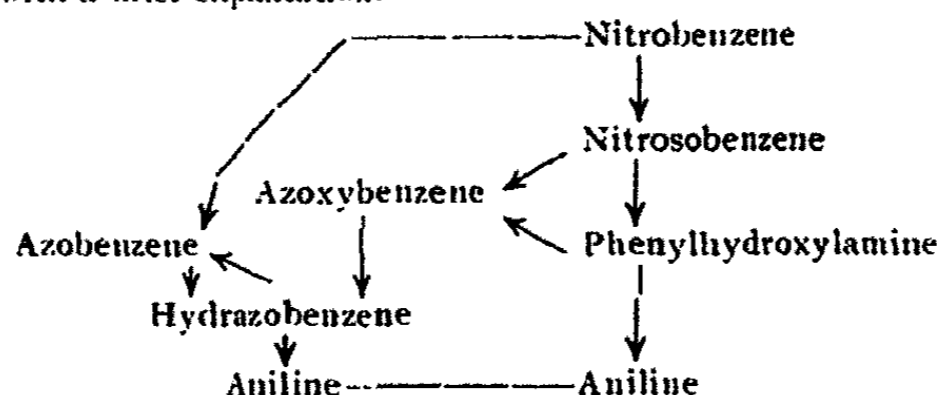

The vertical arrows represent direct reduction while the oblique ones indicate secondary reactions. Thus azoxybenzene is regularly formed from nitrosobenzene and phenylhydroxylamine as follows:

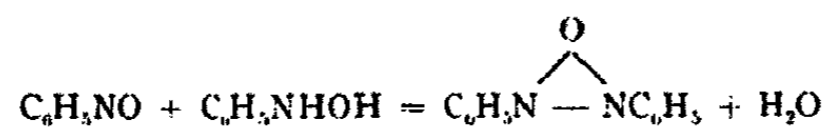

and azobenzene results from the oxidation of hydrazobenzene by nitrobenzene according to the following:

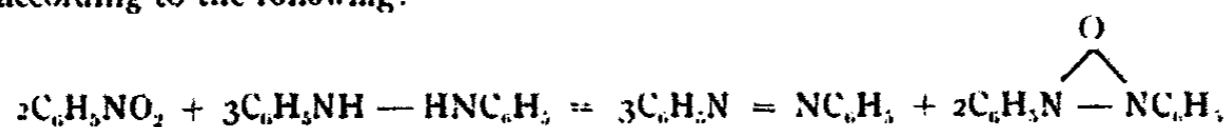

however, other reactions take place for the formation of these and other substances not indicated in the diagram. A number of rearrangement-reduction products are not shown in the above as they are not of special interest in the present work.

<sup>2</sup> Zeit. Elektrochemie, 4, 506 (1898); 6, 512 (1900); Zeit. phys. Chem., 32, 271 (1900).

In order to further test the absence of formation of intermediate products, even with a very slow addition of the alkali a combined electrolytic-chemical reduction was made as follows: An electrolytic cell was fitted up with a 350 cc beaker and a porous cup. The cathode compartment was within the cup and was formed by a platinum cathode 2.5 cm  $\times$  6 cm surrounded with a solution of  $\text{FeSO}_4$  and  $\text{Na}_2\text{SO}_4$  and contained nitrobenzene, while surrounding this was the anode compartment containing a solution of  $\text{Na}_2\text{SO}_4$  made slightly acid with  $\text{H}_2\text{SO}_4$  and a lead anode. A current of about 2 amperes was passed through this cell for about 1 hour. This should liberate sodium at the cathode which would react with the water present and slowly render the cathode solution alkaline thus making it possible for the ferrous iron present to reduce the nitrobenzene.

With pure electrolytic reduction and the use of a platinum cathode only traces of aniline are obtained and the main products of reduction are the intermediate substances but in the above experiment only traces of the intermediate reduction products are obtained; the principal one being phenylhydroxylamine; while the yield of aniline was 23 percent the residue being, for the most part, unconverted nitrobenzene. This is rather a low yield of aniline but it could no doubt be materially increased by stirring the solution and regulating other conditions more carefully.

The principal feature of this run is the fact that aniline is produced and the intermediate reduction products are absent; the run corresponding so far as results are concerned to a very slow addition of the  $\text{NaOH}$  solution or Method 2. The same explanation probably applies that has already been given as regards the production of aniline.

In a few runs the  $\text{NaOH}$  and nitrobenzene were dissolved in alcohol and this solution added to the solution of  $\text{FeSO}_4$ . This method seemed to give an increase in yield of aniline at the boiling temperature but the effect was no doubt quite largely due to the lowering of temperature produced by the alcohol rather than to the variation in method of addition.

With Method 3 the variation in yield of aniline is most marked and in every case is less than that obtained with corresponding runs by the other methods. This fact is no doubt due to the strongly alkaline solution in which the reduction is taking place and which would favor the secondary reactions according to the Haber scheme. Since hydrazobenzene is ultimately formed from these secondary reactions and this is reduced to aniline with difficulty by this reducing medium, the principal final product may not be aniline but one of the intermediate products.

The final products obtained by the third method vary widely with conditions as is shown later but the results given in Table II are believed to be strictly comparable and characteristic for the three methods.

TABLE III.—TEMPERATURE

Run No.	Method No.	FeSO <sub>4</sub> (Anhyd.) g.	Water cc	Solid NaOH g.	Solution cc	Nitrobenzene g.	Temperature °C	Aniline Percent	Hydrazobenzene Percent	Azobenzene Percent	Azoxybenzene Percent	Nitrobenzene Percent	Total Percent
69	1	12.6	60	8	20	1.2	R	100	"	"	"	"	"
74	1	12.6	60	8	20	1.2	57	97	t	t	"	"	"
77	1	12.6	60	8	20	1.2	77	89	O	O	O	6	95
75	1	12.6	60	8	20	1.2	B	80	O	O	O	1	81

TABLE IV

71	3	12.6	60	8	20	1.2	—7	80	O	O	13	4	97
89	3	12.6	60	8	20	1.2	R	58	T	t	33	1	92
81	3	12.6	60	8	20	1.2	74	21	52	8	14	2	97
80	3	12.6	60	8	20	1.2	B	35	54	T	3	3	95

(Compare also 7, 10, 12; 15, 11, 14; 9, 13, 17; 98, 91; 47, 39).

The effect of varying the temperature as would be supposed is quite marked in all cases, however, it would hardly be expected that at lower temperatures the yield of aniline would always be greater but this is the case and is clearly shown in Tables III and IV.



If we accept Haber's scheme for the reduction of nitrobenzene this may be explained by supposing that the nitrosobenzene and phenylhydroxylamine react comparatively slowly for the formation of azoxybenzene at lower temperatures. The reduction to aniline, on the other hand, takes place quite rapidly and easily as has already shown, consequently this latter reduction is the one that takes place to the greatest extent at the lower temperature with a corresponding increase in the yield of aniline.

That the change in yield of aniline is not directly proportional to the change in temperature is shown by a glance at Curves No. VII and VIII, and a little variation at the higher temperatures may make considerable difference in the results, a point that has commercial significance.

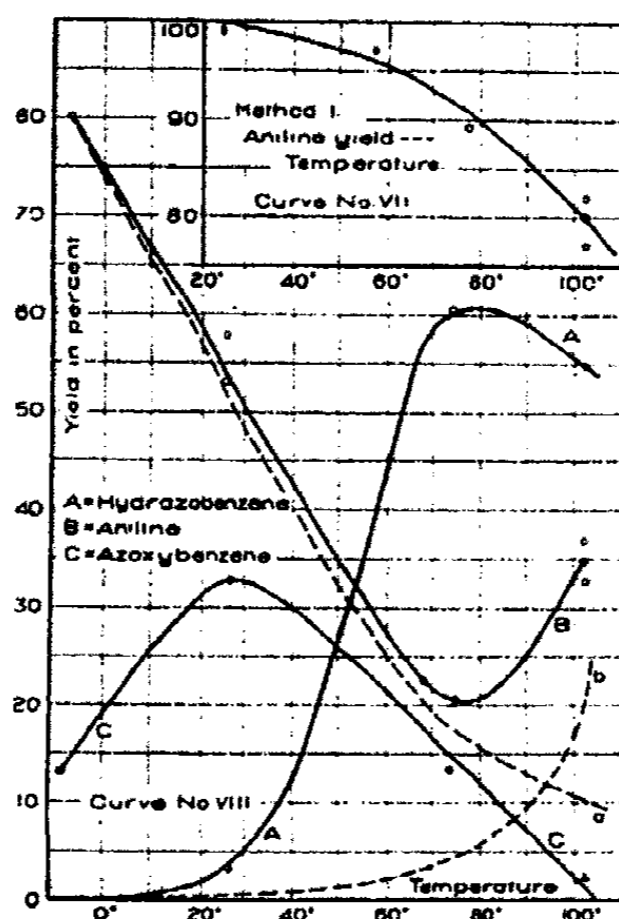

Curve No. VII shows how the yield of aniline increases from 80 percent at boiling to 100 percent at room temperatures for Method I with the same excess of reducing agent present in each case.

It will be noticed that at boiling temperatures with either

the first or second method of addition not to exceed 85 percent of the nitrobenzene could be accounted for. As has been mentioned this is no doubt due to a certain amount of decomposition that takes place at the higher temperatures. Upon evaporating the benzene extract from the runs made at boiling temperatures a very small amount of dark red to black residue was obtained which was practically insoluble in the ordinary organic solvents and water and which never exceeded 2 percent of the original nitrobenzene used. No doubt a similar decomposition took place in the mixture during the run and gave products that were not extracted by the benzene and so were not recovered. This decomposition may result from phenylhydroxylamine of which traces were nearly always present and which might accumulate in this solution. This failure to account for about 20 percent of the theoretical products has been noted by Löb.<sup>1</sup>

It was thought that perhaps some of the products were adsorbed or occluded by the precipitate in the mixture at the moment of reduction but repeated extractions of the precipitate and of the solution after dissolving the hydrated  $\text{Fe}(\text{OH})_3$  precipitate in acid failed to account for more than about 3 percent of the nitrobenzene used. About all that can be said regarding this residue is that it was certainly not any of the regular reduction products that were being determined but probably resulted from some decomposition that took place under these conditions.

With Method 3 at the boiling temperature this decomposition does not seem to take place to any extent which may be due to the fact that the solution is strongly alkaline, thus keeping the concentration of the phenylhydroxylamine very low because of its unstability in alkaline solution.

In Curve No. VIII, which is plotted from Table IV for the third method of addition, a well defined minimum is shown in the yield of aniline at about  $75^\circ$  or probably somewhat higher. This may be explained from the following considera-

---

<sup>1</sup> Löb: Ber. chem. Ges. Berlin, 29, 1894 (1896).

tions: At room temperature and with an excess of from three to four times the amount of reducing agent present necessary to convert to aniline neither azo- nor azoxybenzene is reduced to aniline to any appreciable extent. A number of tests were made on this point and never more than 1.5 percent of aniline was obtained. Both remained unaltered for the most part though some hydrazobenzene was formed in each case. At boiling temperature, however, they are so reduced, as much as 23 percent of aniline being obtained in some of the trials that were made. Intermediate temperatures would no doubt show intermediate amounts of aniline. It is evident then that part of the aniline recovered at boiling temperatures is not produced by the direct reduction of the nitrobenzene over the nitrosobenzene-phenylhydroxylamine route but results from a reduction of the secondarily formed azoxybenzene to hydrazobenzene and then to aniline and thus causes a rise in the curve for aniline at the higher temperatures.

The final curve may be regarded as the sum of the two hypothetical dotted curves (*a*) and (*b*) (Curve VIII) in which (*a*) represents the aniline formed through direct reduction and (*b*) shows the part obtained from the reduction of the secondarily formed azoxybenzene. That curve (*a*) must have a bend at the higher temperatures and not cross the 0 percent yield of aniline axis at about 100° is evidenced from the fact that azoxybenzene will not be reduced in sufficient quantity to account for the yield of about 35 percent of aniline obtained in several runs at these temperatures.

The variations in the intermediate products formed are also to be explained from the fact that at room temperature azoxybenzene is practically unaffected by this reducing medium while in the boiling mixture it is reduced to hydrazobenzene and aniline; consequently, most of the azoxybenzene formed at room temperature is recovered as such while at boiling temperature it will be further reduced to hydrazobenzene providing there is an excess of the reducing agent present. From the above it is clear that at lower tempera-

tures, with Method 3 and an excess of reducing agent present, aniline and azoxybenzene will be the reduction products and as the temperature rises the azoxybenzene increases and passes through a maximum of about 33 percent at room temperature while the aniline diminishes and passes through a minimum of 21 percent at about 75°.<sup>1</sup> Meanwhile, with rise of temperature hydrazobenzene is formed by reduction of azoxybenzene, the maximum yield of 60 percent being at 75° and corresponding to the minimum yield of aniline. At a temperature of about 50° the azoxy-, hydrazobenzene and aniline are formed in approximately equal amounts. (Curve VIII.)

Azobenzene behaves in a manner very similar to azoxybenzene under like conditions. A test of each was made by reducing with an excess of hot reducing agent and after shaking out with very dilute H<sub>2</sub>SO<sub>4</sub>, extracting with benzene and evaporating the benzene the residues obtained in each case were identical, showing a melting point without recrystallizing of 118°–122° and were no doubt nearly pure hydrazobenzene. The aniline yield from azobenzene was somewhat the higher but this point was not studied more definitely.

The use of alcohol in the usual electrolytic methods of preparing hydrazobenzene and azobenzene is evidently not entirely a matter of keeping the nitrobenzene and azoxybenzene in solution but serves as an automatic regulator of temperature and by its boiling keeps the temperature of the solution near the most favorable point for a minimum yield of aniline and a maximum yield of the intermediate products.

One of the surprising runs of the series is No. 71 which was made with the flask immersed in a freezing mixture that registered a temperature of -7°. In this case the nitrobenzene had completely solidified before the addition of any of the ferrous sulfate solution, however, the stirring had been going on and the nitrobenzene was in a state of quite fine

<sup>1</sup> The temperature for minimum yield of aniline is probably somewhat higher than shown on the curve but was not determined exactly.

division. The interior of the flask could not be seen and at the end of about 1 hour, on discontinuing the run the entire contents of the flask were found to be solidified, the stirrer simply revolving in a small open space. The high yield of over 80 percent aniline was considered rather remarkable. Run No. 47 is of the same general kind, in this case the flask being immersed in ice water and the aniline yield of 39 percent is quite high for the amount of reducing agent used.

NOTE.—The azobenzene is taken with the hydrazobenzene in most of the above considerations as there seems to be little doubt of its being formed from hydrazobenzene by oxidation.

TABLE V.—CONCENTRATION, QUANTITY  $\text{FeSO}_4$ , ETC.

Run No.	Method No.	$\text{FeSO}_4$ (Anhyd.) g.	Water cc	NaOH solid g.	Solution cc	Nitrobenzene g.	Temperature $^{\circ}\text{C}$	Aniline Percent	Hydrazobenzene Percent	Azobenzene Percent	Azoxybenzene Percent	Nitrobenzene Percent	Total Percent
21	1	22	60	16	20	1.2	B	74	u	u	u	u	u
20	3	22	60	16	20	1.2	B	73	u	u	u	u	u
86	1	6.6	60	8	20	1.2	R	39	0	0	5	52	96
64	1	12.6	60	8	20	1.2	R	99	0	1	0	u	u
88	1	12.6	60	4	20	1.2	R	28	0	0	0	63	91
87	3	5.2	60	8	20	1.2	R	8	0	0	20	64	92
85	3	6.6	60	8	20	1.2	R	15	0	0	37	44	96
89	3	12.6	60	8	20	1.2	R	58	1	1	33	1	92
91	3	12.6	60	4	10	1.2	R	23	1	0	35	37	95
96	3	4.9	60	8	20	1.2	B	24	1	0	51	14	90
95	3	6.6	60	8	20	1.2	B	30	9	7	51	1	98
80	3	12.6	60	8	20	1.2	B	35	54	1	3	3	95
97	3	6.6	80	6	75	1.2	B	19	13	5	55	2	94
98	3	6.6	80	4	100	1.2	B	18	0	0	76	2	96
99	3	6.6	80	3	100	1.2	B	5	0	0	65	13	83

With a large excess of reducing agent it will be seen (Table V) that all methods approach the same final products. This would be expected as the use of a very concentrated ferrous sulfate solution with Method 3 is practically equivalent to a more rapid addition of the ferrous sulfate solution and approaches a simultaneous addition of all the substances,

under which condition aniline is the principal product of reduction.

With Method 1 it may also be noted that at the boiling temperature a large excess of the reducing agent does not increase the yield of aniline, only about 80 percent being obtained in any case. This strengthens the conclusion that there must be some decomposition in the solution and the products so formed are not capable of being reduced to aniline with this mixture. If the amount of ferrous sulfate is decreased until the amount is insufficient to completely reduce the nitrobenzene the principal result seems to be a cutting down of the amount of aniline and a corresponding increase in the quantity of unaltered nitrobenzene, though azoxybenzene is also present in very small amount. A decrease in the amount of NaOH, on the other hand, seems to practically eliminate the intermediate products and gives a decrease in the yield of aniline and increase in the unaltered nitrobenzene. This is the only difference observed in the results obtained by the first two methods and is in line with the facts already noted, that in a strongly alkaline solution the phenylhydroxylamine formed reacts with nitrosobenzene and forms azoxybenzene while in the weaker alkaline solution this does not take place so extensively.

At room temperature with Method 3 the effect of cutting down the ferrous sulfate or sodium hydroxide is primarily to cut down the aniline yield and give a corresponding increase in the amount of unreduced nitrobenzene without materially changing the intermediate products but after a certain point is reached the intermediate products are also diminished.

It is in the case of Method 3 at the higher temperatures that varying the amounts of ferrous sulfate or sodium hydroxide produce the most varied results so far as intermediate products are concerned and by consulting the table it is that a yield of 60 percent hydrazo- or 76 percent azoxybenzene is possible by diminishing the quantity of ferrous sulfate by only a very small amount (No. 93, 95). In all the above

cases, only a very small quantity of azobenzene is formed and no evidence was obtained that showed that it might not be obtained by oxidation of the hydrazobenzene. The use of more dilute solutions of ferrous sulfate or sodium hydroxide solutions are favorable to the formation of intermediate products with a corresponding decrease in the aniline yield.

The following points in connection with the reducing agent are worthy of note at this place.

An excess of about 30 percent of the ferrous sulfate is necessary to produce a theoretical yield of aniline at room temperature and in no case is the reducing agent entirely oxidized at this temperature.

At boiling temperature, however, the iron will be completely oxidized when present in insufficient quantity for complete reduction, providing there is nitrobenzene left in the solution. For example the reduction products in No. 96 require 4.9 grams of anhydrous ferrous sulfate which is exactly the amount used and in this case there was still unreduced nitrobenzene. A very weak solution of this reducing agent will evidently attack nitrobenzene. If the nitrobenzene is all reduced and intermediate products formed the iron may not be completely oxidized and a considerable excess of the reducing agent seems to be necessary to attack some of these products. In No. 95 the anhydrous ferrous sulfate called for by the reduction products is 6.2 grams while 6.6 grams were actually present. The excess in this case was not sufficient to attack the azoxybenzene in the solution and reduce it to hydrazobenzene (see also No. 98). This is exactly in line with the results obtained by Haber in the electrolytic reduction.<sup>1</sup>

NOTE.—A run using  $\text{Na}_2\text{CO}_3$  instead of NaOH gave the following: Aniline, 47 percent; nitrobenzene, 14 percent; azobenzene, 0 percent; hydrazobenzene, 0 percent; azoxybenzene, 31 percent; and the phenylhydroxylamine was apparently present in greater quantity than in the NaOH runs. The high yield of aniline and presence of unaltered nitrobenzene seemed to indicate that no high yield of intermediate products was probable by this method and no further tests were made.

<sup>1</sup> Zeit. Electrochemie., 4, 506 (1898).

TABLE VI.—RATE OF ADDITION, STIRRING, ETC.

Run No.	Method No.	FeSO <sub>4</sub> g.	Water cc	NaOH g.	Solution cc	Nitro g.	Temperature °C	Aniline Percent	
70	1	12.6	60	8	20	1.2	R	100	
69	A	12.6	60	8	20	1.2	R	99	
65	2	12.6	60	8	20	1.2	R	95	Added in fast drops.
83	2	12.6	60	8	20	1.2	R	96	Added in slow drops.
9	3	12.6	60	8	20	1.2	B	58	Added in fast drops.
26	3	12.6	60	8	20	1.2	B	33	Added in slow drops.

From Table VI it will be seen that the rate of addition of the third substance when it is the nitrobenzene or NaOH makes very little difference in the end products but with the FeSO<sub>4</sub> solution the slower the addition the less amount of aniline formed. This is true at least within certain limits and is more noticeable if we consider that when all the substances are introduced together or the FeSO<sub>4</sub> solution poured rapidly into a mixture of NaOH and nitrobenzene the yield of aniline at room temperature is 100 percent; when added in fast drops about 60 percent of aniline is formed while a very slow addition of the FeSO<sub>4</sub> solution gives as low as 20–30 percent of aniline but a still slower addition of a more dilute solution does not seem to diminish the aniline yield.

The stirring plays quite an important part and there is no doubt that the more rapid the solution is stirred the faster the third substance may be added and give like results. The end products may also be partly determined by the stirring but this point was not studied. Run No. 72 which shows 97 percent aniline was not stirred, the substance simply being placed in an Erlenmeyer flask, given a single small turn to mix the NaOH and FeSO<sub>4</sub> solutions and allowed to stand over night at room temperature. The reaction would undoubtedly have taken place much quicker with stirring, at most in less than 5 minutes as was shown in Run No. 69.



**General Conclusions**

Method 3 assumes more importance from the electrolytic standpoint when it is remembered that in reducing by means of an electric current the condition is essentially that of a very slow addition of the reducing agent. The first two methods are impossible to duplicate in the electrolytic way as they would call for an infinite current in a very short time. It should be possible, however, to duplicate the electrolytic preparations with fairly good results by Method 3 if we choose a suitable concentration of  $\text{FeSO}_4$  solution, add it at a proper rate and under suitable conditions.

At first thought it might appear that the conditions in some of the above runs were approximately the same as those that obtain in the usual electrolytic processes but there is a difference which assumes considerable importance if Haber's views are correct and the azobenzene is formed from the hydrazo- and nitrobenzene according to the equation already given.

In the chemical reduction and with stirring the reducing agent is distributed throughout the solution and undoubtedly more nearly attacks all the substance at the same time. As already shown (No. 95, 96) at the higher temperatures very little if any excess of reducing agent is necessary to reduce nitrobenzene while considerable excess is required to reduce azoxybenzene. That nitrobenzene is easier to reduce than azoxybenzene at room temperature is shown from the fact that the first is easily reduced to aniline while the second is practically unaffected. This being the case and knowing the rapidity of the reaction we may assume that when the drop of reducing agent enters the mixture there is only a very short time at most that the concentration is sufficient to reduce the azoxybenzene while it will continue to reduce the nitrobenzene until the reducing agent is exhausted. This entire reduction may take place before the next drop is introduced when the same cycle will be repeated, but as long as there is nitrobenzene present in the solution no large quantity of azoxybenzene can be reduced. With the disappearance

of the nitrobenzene, however, the concentration of the ferrous sulfate may increase to a point where the azoxy- will be reduced to hydrazobenzene. A study of Table I will show that in no run is there present in the solution at the same time any considerable quantity of nitro- and hydrazobenzene, hence the absence of more than a trace of azobenzene in these reductions. This trace may be accounted for if we assume that when the drop of ferrous sulfate solution is first introduced a little azoxybenzene may be reduced to hydrazobenzene which would in turn react with the nitrobenzene for the formation of the azobenzene.

In electrolytic reduction, on the other hand, the sphere of action is confined to the comparatively limited space of electrode surface and only those particles are reduced that come within this space. With the large drop of potential, which is the condition that usually prevails, nitrobenzene or azoxybenzene will be indiscriminately reduced. The hydrazobenzene formed from the reduction of the azoxybenzene before the nitrobenzene disappears should react with the nitro- for the formation of azobenzene. The low yield of azoxybenzene in the usual electrolytic reduction follows from the same consideration as part of it would no doubt be further reduced before a high yield was obtained. This would be more particularly true during the later part of the reduction as the concentration of the azoxybenzene increased.

In the chemical reduction it is possible to determine the point at which the nitrobenzene is all reduced and at which the azoxybenzene is not attacked and stop the reduction with a good yield of azoxybenzene. This same thing is also possible with electrolytic reduction providing the drop in potential is kept low enough to attack the nitrobenzene but not affect the azoxybenzene.

A rather interesting check was made upon some of the above statements in the following manner. A run in every way similar to No. 93 was made which should produce a yield of about 57 percent of hydrazobenzene. After the addition of the ferrous sulfate solution the mixture was boiled a short

time and then 1.2 grams more nitrobenzene was added and the boiling continued for about 20 minutes. The mixture was then extracted and after shaking out the aniline the extract was shaken with dilute sulfuric acid and only a trace of hydrazobenzene was obtained while the azobenzene which was determined at once amounted to 47 percent of the theory for the nitrobenzene first added. The iron in the solution must have been completely exhausted before the second addition of nitrobenzene as the amount added was insufficient to completely reduce the first portion added. A determination of the unacted upon nitrobenzene showed 54 percent of the second addition.

It is evident that the difference in products between this run and No. 93 must be due to the second addition of nitrobenzene acting on some product already in the solution and the most noticeable thing is the almost quantitative change of the hydrazobenzene in No. 93 for azobenzene in the last run. Azoxybenzene was also present in considerable quantity but was not determined and the presence of unconverted nitrobenzene would be expected since excess was added.

This second introduction of nitrobenzene produces the condition that makes the chemical and electrolytic reduction more nearly correspond if the previous conclusions are correct and it is evident that as the two conditions are made to approach each other the products of reduction in the two methods agree in a very satisfactory manner.

The following conclusions were arrived at relative to the object of the present work as stated in the first part of the paper. It is very doubtful if it is possible to check the actual reducing power of a substance by the products of reduction of nitrobenzene and in this way compare values with the single electrolytic potentials of the same solutions of the substances taken against a standard electrode. This is due to a number of facts which may be briefly reviewed at this place and some of which have been brought out in the foregoing work.

There are quite a number of variables that enter into the

consideration and some of these are quite difficult to control. This is clearly shown by the different results obtained when some of the above runs were made as near in duplicate as possible.

The stability of the end product in the particular solution used is a determining factor—as is shown from the fact that only traces of phenylhydroxylamine were obtained in any of the runs made. This is due, at least, in part to its being unstable in the alkaline solutions used.

It would be difficult to obtain a standard of "reducing power" in a chemical reduction as it might be inferred from some of the results obtained above that since nitrobenzene is reduced quantitatively to aniline in the cold and in a boiling solution only about 80 percent aniline is obtained, the former is the stronger reducing agent but if judged from the effect on azoxybenzene exactly the opposite conclusions must be drawn. The cause of this discrepancy has already been given.

In all speculations regarding the ability of one substance to reduce another it is necessary to take into consideration that there may be very different results depending upon whether the substance to be reduced is in the so-called nascent or in the molecular condition and that one substance does not reduce another when the first is added to it is no positive proof that it would not do so if the second substance were being formed in the presence of the first or reducing substance.

#### **Electrolytic**

A few electrolytic runs were made which it is believed have some value in connection with the above work and a brief abstract of them will be introduced here for the sake of completeness. In these runs it was only desired to ascertain whether or not certain substances were formed in considerable quantity and complete analyses were not made but only rough quantitative tests for the substances desired. Other reduction products than those mentioned were always present. In all these trials a lead anode was used and the anode solu-

tion consisted of a water solution of  $\text{Na}_2\text{SO}_4$ , made slightly acid with  $\text{H}_2\text{SO}_4$ , while the cathode solution consisted of nitrobenzene in aqueous alcohol plus a sodium salt.

Run	Cathode	Salt	Current	Temp.	Products
E I	Ni 5 × 10 cm.	NaOH	0.6 A	R	Azoxy-, nitrobenzene
E II	Ni 5 × 10 cm.	NaOH	4.0 A	80°	Hydrazobenzene, aniline
E III	Cu	NaOH	1.5 A	80°	Hydrazobenzene, aniline
E IV	Cu gauze rotated	NaAc	0.4 A	B	Azoxybenzene
E V	Cu gauze rotated	NaOH	5.0 A	75°	Azobenzene

It is hardly necessary to go into any details concerning the electrolytic reduction of nitrobenzene in view of the excellent papers already referred to by Haber, Elbs and others, however, it may be observed that the end products are largely determined by the current strength which is, of course, a measure of the drop in potential.

#### Conclusions

As a result of the foregoing work the following points have been developed:

(1) A method of analysis for mixtures of the substances involved which gives fairly satisfactory results.

(2) It has been shown that by the use of a single reducing agent it is possible to obtain fair yields of the various reduction products of nitrobenzene and the conditions necessary for each product have been ascertained.

(3) Practically identical results are obtained by adding nitrobenzene to a mixture of  $\text{FeSO}_4$  solution and NaOH or by adding NaOH solution to the mixture of nitrobenzene and  $\text{FeSO}_4$  solution or by adding all together. The principal product in each case and under all conditions is aniline with only traces of other products.

Each of the methods with an excess of reducing agent yields: Boiling temperature; aniline, 80 percent; room temperature; aniline, 100 percent.

(4) By adding the  $\text{FeSO}_4$  solution to a mixture of nitro-

benzene and NaOH solution various products may be obtained as follows:

Add excess of  $\text{FeSO}_4$  solution very quickly at room temperature, aniline = 99 percent.

Add excess of  $\text{FeSO}_4$  solution fast drops, boiling temperature, aniline = 58 percent.

Add excess of  $\text{FeSO}_4$  solution very slowly at  $75^\circ$ , aniline = 21 percent.

Hydrazobenzene = 60 percent; azoxybenzene = 14 percent.

Add slowly to boiling mixture a slight excess over the amount of  $\text{FeSO}_4$  calculated to reduce to hydrazobenzene.

Aniline = 33 percent; hydrazobenzene = 58 percent.

Add slowly to boiling mixture a slight excess over amount of  $\text{FeSO}_4$  calculated to reduce to azoxybenzene. Aniline = 18 percent; azoxybenzene = 76 percent.

(5) Azobenzene can be formed by oxidation of hydrazobenzene with nitrobenzene.

(6) A number of points have been brought out that simplify the connection between the pure chemical and electrolytic reduction of nitrobenzene to aniline and intermediate products.

(7) In the Elbs method of electrolytic preparation of azobenzene the azobenzene undoubtedly goes through the azoxybenzene stage which can be shown by stirring and low current density (see E IV).

(8) Increasing the current density decreases the amount of azoxybenzene found in the solution.

In conclusion I express my thanks to Professor Bancroft, to whose numerous suggestions and continual encouragement much of whatever is valuable in the above work is due.

*Cornell University*

## NEW BOOKS

**Traité de Physique.** By O. D. Chwolson. *Ouvrage traduit sur les Éditions russe et allemande par E. Davaux. Édition revue et considérablement augmentée par l'Auteur, suivie de Notes sur la Physique théorique par E. Cosserat et F. Cosserat. Tome troisième, second fascicule. 16 × 25 cm; pp. vii + 336. Paris: A. Hermann, 1910. Price: paper, 11 francs.*—This section of the third volume contains general thermodynamics, fusion and vaporization. On p. 476 we find an interesting discussion of the theorem of LeChatelier.

“As introduction to our further studies we will take up the theorem of LeChatelier-Braun. It tells us less than the second law of thermodynamics because it gives no information as to the quantitative laws governing physical phenomena; but what it has in common with the second law is very interesting. It indicates the direction in which a physical change will go under given conditions. One might think that the theorem of LeChatelier-Braun would be of no importance in comparison with the second law of thermodynamics which tells us so much more, but this is not the case. The application of the second law to physical phenomena calls for advanced knowledge in making the analysis and for great care in drawing the conclusions. The conclusions are also in a mathematical form and may not be readily applicable. On the other hand the theorem of LeChatelier-Braun appears as a simple rule, which is easily remembered and which therefore may render great service. It enables us to keep clear the regular but complex sequence of phenomena, to straighten out difficult cases, and even to predict new facts. The theorem ought to be much more widely known than it is and it ought to be introduced into the elementary teaching instead of the second law of thermodynamics because this latter cannot be made easily applicable.”

On p. 502 the author apparently takes quite seriously Ostwald's formulation that “of all the possible transformations of energy, that one will take place which causes the greatest change in a given time.” It is not possible for this to be true and at the same time to accept Ostwald's so-called law of the primary formation of the instable phase.

The phenomena of liquefaction and evaporation are treated, as they should be, from the phase rule point of view. The author accepts Tamman's view that amorphous substances are supercooled liquids but he falls into the usual error, p. 616, that superheating of a solid is practically unknown. It is quite easy to superheat acetaldoxime 30° and the phenomenon is a general one in all cases where a second modification is formed slowly in the melt. W. D. B.

**Traité de Physique.** By O. D. Chwolson. *Ouvrage traduit sur les Éditions russe et allemande par E. Davaux. Éditions revue et considérablement augmentée par l'Auteur, suivie de Notes sur la Physique théorique par E. Cosserat et F. Cosserat. Tome quatrième, premier fascicule. 16 × 25 cm; pp. vii + 430. Paris: A. Hermann, 1910. Price: paper, 12 francs.*—This section deals with the phenomena connected with a constant electric field. In the introduction, p. 3, there is an interesting account of the present state of our knowledge.

“In order to form a truly scientific judgment on any part of physics, it is

necessary to have a *clear understanding* of the significance at that moment of a given theory or given hypothesis. Let us suppose that there is a conflict between different hypotheses or theories, that people defend each obstinately as applied to some part of the subject, and that it is necessary to substitute the reasonings, deductions and conclusions of one of these hypotheses or theories for those of another when passing from one part of the subject to another. In such a state of things, anybody, who thought that the struggle might end, that one of the theories might prevail, and that it was possible to present all parts of the subject from a single point of view, would be considered as not having a clear understanding of that branch of science.

"This is exactly the state of things with regard to the electrical and magnetic phenomena. Without exaggeration we may say that, in the part of this science which deals with the *explanation* of the phenomena, there is no solidly established theory on which one can rely with absolute safety and which will take account of *all* the phenomena."

The author distinguishes the electrostatic phenomena, the magnetic phenomena, the phenomena connected with the electric current, the phenomena of electrical radiations, the phenomena of the electrical discharge and the phenomena of radioactivity. He points out that there is no single theory which takes account satisfactorily of all these phenomena.

On p. 205 the author discusses the problem of the voltaic cell. In a cell of the Daniell type he calls  $e_4$  the potential difference between the metals;  $e_3$  and  $e_1$  are the differences of potential between zinc and zinc sulphate, copper and copper sulphate respectively; while  $e_2$  is the potential difference between the two solutions and the sum of the four is  $E$ , the electromotive force of the cell. "Where are we to look for the source of the difference of potential which we observe in a cell on open circuit? Is it where the metals are in contact, where the electrolytes are in contact with the metals, or in both sets of places? Many authors of high standing believe that  $e_4$  is very small in comparison with  $e_1$  and  $e_3$  and that it does not exceed a few thousandths of the value of  $E$ . Consequently the contacts between the metals and the electrolytes are the chief sources of the electromotive force of a cell and are the only ones that need ordinarily be considered. This is the view held by the German school of electrochemists: Ostwald, Nernst, Jahn, LeBlanc, Lüpke and others. There are other scientific men, especially in England (Lodge for instance) who believe that  $e_4 = 0$  and that the contact between two metals gives rise to no electromotive force. [This is scarcely a fair statement of Lodge's view.] At the same time we see physicists, no less distinguished, measuring the values of  $e_4$  for different pairs of metals and finding that  $e_4$  may be half, three-quarters or even a larger fraction of  $E$ , so that  $e_4$  may run up almost to a volt. We find innumerable experiments and measurements by both sets of partisans and also criticisms of the experiments, which appear sometimes to have nothing to do with the subject and almost to demonstrate ignorance on the part of the objectors as to what they are trying to prove. It is not for us to take sides with either party nor to adopt one opinion on the other as to the value of  $e_4$ . Our business is simply to present a sketch of the actual state of the science and to show what has been done by both sides. Although the fundamental problem has not yet been solved, that will not interfere with a presentation of the facts because the



really important thing is the value of  $E$ , the sum of the disputed single potential differences, and there is no disagreement as to the value of  $E$ ."

The last chapter is devoted to atmospheric electricity. Of general interest is a paragraph on p. 423. "Brillouin (1900) found that when ice is electrified negatively it loses its charge rapidly under the influence of ultraviolet radiations and that this does not take place when we have water instead of ice. From this he deduced the following theory. If there is an electric field in the atmosphere at any moment, the needles of ice in the cirrus clouds are electrified positively at one end and negatively at the other. If the negatively charged ends of the ice needles are exposed to solar ultraviolet radiations, the needles thus illuminated lose all their negative charge and become electrified positively. Brillouin assumes that the negative electricity lost by the needles of ice is taken up by the surrounding air. When the needles separate from the surrounding air, the whole of the cloud appears positive. When cirrus clouds are formed by mixing, there are frequent independent movements of neighboring masses of air, some of which are cloudy and some of which are clear. The negatively charged air separates from the positively charged cirrus. If the mass of negatively charged air descends until it reaches the ground, the innumerable leaves and blades of grass facilitate the transfer of electricity from the air to the soil. The ground becomes charged negatively with respect to the air. At the surface of the ocean it is quite different. The air remains negative and becomes saturated with water vapor. When this vapor, on expansion, condenses to fine drops, these latter act like fine points and take the charge from the air. The cumulus clouds near the ocean are therefore negative. At the surface of the earth no direct action of ultraviolet radiations can be detected because almost no such radiations get thus far and because water is not sensitive to them.

Wilder D. Bancroft

*Traité de Chimie générale.* By W. Nernst. Translated from the sixth German edition by A. Corisy. Part I. 17 X 25 cm; 510 pp. Paris: A. Hermann et Fils, 1911. Price: paper, 12 francs.—This French edition is translated from the sixth German edition, which is very different from the earlier ones. This first volume only includes the general properties of substances and the special facts connected with atoms and molecules. The headings of the chapters are: introduction; gases; liquids; solids; physical mixtures; dilute solutions; atomic theory; kinetic theory of molecules; determination of molecular weights; constitution of molecules; physical properties and molecular structure; dissociation of gases; electrolytic dissociation; physical properties of salt solutions; atomic theory of electricity; metals; radioactivity; colloids; absolute size of the molecules.

Nernst defines a crystal, p. 84, as a homogeneous substance in which the physical properties vary in different directions from any point inside the crystal. In this definition no mention is made of the geometrical form of the limiting surface because this form is only the outward sign of the crystalline state. The definition thus includes the liquid crystals and excludes amorphous substances, which is as it should be.

Stress is laid, p. 309, on the fact that the molecular weight of the liquid solvent does not appear in the van't Hoff-Raoult formula. On the other hand,

it is rather implied, p. 137, that melted isomorphous mixtures may coexist over the whole range with crystals of identically the same composition as the melt. This is theoretically impossible and it has been shown that Küster's assumption to the contrary was due to the lack of sufficient accuracy in the experiments.

The paragraph on dualistic and monistic theories, p. 323, is very good and so is the next one on variable valence. The chapter on colloids is not up to what it should be. Nerust believes that vapor pressure measurements, pp. 480-483, enable us to determine the true molecular weights of colloids; the treatment of peptonization and pectization is absurdly inadequate; and the whole chapter has been written in a purely perfunctory way.

The translator has done his work well but he has not furnished a name index or a subject index. It may be that these will appear in the second part.

*Wilder D. Bancroft*

---

**Electro-Analysis.** By *Edgar F. Smith*. Fifth edition. 19 × 15 cm; 328 pp. Philadelphia: P. Blakiston's Son & Co., 1911. Price: \$2.50 net.—  
In the preface the author says:

"The greater portion of the new material, presented in the pages which follow, refers to the rapid precipitation and separation of metals, the use of a mercury cathode with rotating anode and the employment of a new cell in the determination of cations and anions. To give this material the space it so abundantly deserves suggested the elimination of the minute directions found in the various electrolytes used with stationary electrodes, but it developed that beginners in electro-analysis learn much from the execution of details, the handling of deposits and other points which arise constantly in work of this character. Further there will always be persons who, from preference or from the lack of facilities to carry out the newer methods, will make determinations and separations with stationary electrodes. Indeed, these earlier methods constitute a fundamental step in the development of analysis through the agency of the current, and are therefore retained in their original forms except where experience has recommended alterations. So long as the time factor continues to be of no moment the older procedures will appeal to the analyst.

"It may be stated that the rapid methods of analysis set forth in detail in this text, including those in which the mercury cathode plays an important rôle, have been subjected to rigorous tests in this laboratory and have invariably brought success to all working with ordinary care.

"The section describing the determination of cations and anions cannot fail to excite interest and inquiry. That the estimation, for example, of barium and chlorine, in barium chloride, may be made in an hour or less, while hours would be required by the time-honored methods, will naturally lead one to pause. The neatness and accuracy of such determinations also recommend them. The determination of the ferro- and ferri-cyanogen and other anions indicates still greater possibilities in the application of the current to analysis.

"The very latest proposals regarding the value of graded potential in separations and the possibility of effecting organic combustions by means of the electric current receive ample consideration. The paragraphs on theoretical considerations will throw much light upon the deportment of metals in solution and assist in explaining many heretofore obscure reactions."

Some people may take issue with the last paragraph quoted; but that has no real bearing on the merits of the book. Mr. Smith is recognized as the leading authority in the world on the practice of electrolytic analysis. We also owe to him more new and varied methods of analysis than to any other man. The only criticism that the reviewer has ever heard in regard to the previous editions is that it has sometimes been difficult to duplicate results obtained with great ease in the Pennsylvania laboratory. The test of a set of directions is not that they shall work well in the laboratory of the inventor of the methods; but that they shall be proof against the marvelous ingenuity of the students in making mistakes when there is no possible justification for so doing. The reviewer hopes that the new edition will stand even this test. *Wilder D. Bancroft*

**Die Theorie des Färbeprozesses.** By L. Pellet-Jolivet. 16 × 25 cm; 224 pp. Dresden: Theodor Steinkopff, 1911. Price: paper, 7 marks; bound, 8 marks.

The subject is discussed under the following heads: general properties of dyes; adsorption; contact electrification; relations between adsorption and contact electrification; different observations on contact electrification and dyeing; relative permanency and fastness of dyes; the nature of the combinations formed during dyeing.

There is a great deal that is interesting in the book. Under general properties the author discusses: classification of dyes; solubility of dyes; composition and nature of basic dyes; electrical conductivity of dyes; conductivity of dyes for cotton; relations between solutions of dyes and colloidal solutions; mutual action of basic and acid dyes; quantitative determination of dyes. Under contact electrification we find, among other sections, one on the effect of salts on dyeing, one on fixing different derivations of the same dye, and one on the mechanism of fixing basic and acid dyes on the fibers. In the fourth chapter the author discusses the adsorption of dyes in presence of electrolytes and also the capillary rise of dyes. The chapter on the fastness of dyes is a bit disappointing because one does not get anywhere. In the last chapter the author expresses the conviction that, in the majority of cases, adsorption is the most important factor in causing the fixing of the dye on the fibers.

The author has given a great number of facts and the book will prove of great value. It has just one serious defect. The author has been so much interested in details that he has nowhere given any presentation of the theory of dyeing. If he would add a final chapter in which he told what we now know about dyeing, it would double the usefulness of the book.

*Wilder D. Bancroft*

**Die Anlauffarben: eine neue Methode zur Untersuchung opaker Erze und Erzmenge.** By Max Leo. 16 × 25 cm; 72 pp. Dresden: Theodor Steinkopff, 1911. Price: 2 marks.—Owing to the difficulty in polishing ore surfaces, the author claims that one cannot use the methods of etching which prevail in metallography. This would seem to be largely a question of knowing how to polish a rock surface. Unless one knows how, it is not easy to polish and etch an alloy containing two soft metals. However that may be, the author has developed a method of coloring different portions of a rock surface by heating, by treating with chemicals, by making the one sample anode or cathode. In

the last case metallic copper is often precipitated on the surface. The method has been tested for sulphide ores and apparently works very well. While the method seems to be a good one, the presentation is extremely bad, the author stating his facts in so confused a way that it is very difficult to make out exactly what he has done.

*Wilder D. Bancroft*

**A Laboratory Manual of Inorganic Chemistry.** By Eugene C. Bingham and George F. White. 14 × 21 cm; v + 146 pp. New York: John Wiley and Sons, 1911. Price: \$1.00.—In the preface the author says:

"The first year's work in chemistry is inevitably concerned with a large number of chemical facts among which the properties of acid radicals and metallic radicals play a prominent rôle. The interest and reality of these facts must ever be in direct proportion to the intimacy of the student's contact with them. Information from text-books, or even the best lecture demonstrations cannot compete with laboratory experimentation in making the facts real. It seems to the authors, therefore, that a course in inorganic preparations and systematic qualitative analysis, with a few carefully chosen quantitative experiments afford the best background for the theoretical development of the science.

"In the study of a rapidly expanding subject, like Chemistry, there is danger of superficiality. Writers are tempted to cover the whole field with many short experiments. The result may be that the teacher comes to feel that the student is not grasping the fundamental facts in the multiplicity of experiments, and he may allow the student to yield to the temptation to hurry. Hence the number of experiments has been cut down to a minimum, necessary for the understanding of the subject in its elementary phases. On these experiments the student may confidently linger until they become a part of himself. Experiments in Organic Chemistry and Physical Chemistry, which may properly be taken up in later years of work, have been studiously avoided. If the student's interest is developed by studying intensively those phenomena which are essential to the thorough development of the subject, he may be intrusted to obtain later those things which naturally follow, but which he might only imperfectly understand if treated in his first year. Their novelty will then add to the student's zest.

"On the other hand, the principles of Physical Chemistry have been freely introduced wherever they seemed necessary to the understanding of the subject in hand, but with as little technical language as possible. Likewise a few quantitative experiments have been introduced which relate directly to the laws which must be mastered during the first year.

"The instructions have been made full, so that no good excuse may be offered for slovenly work, and that at the beginning the student may gain that invaluable technique which can scarcely be learned after bad habits have been formed."

*Wilder D. Bancroft*

**Pure Foods.** By John C. Olsen. 13 × 19 cm; 210 pp. Ginn and Company: New York.—In the preface the author says:

"This volume is the outgrowth of a series of public lectures on foods, which have been given by the author for a number of years. The interest shown by audiences of widely different character, as well as frequent requests for the substance of the lectures in printed form, has led to their publication. The

experimental illustrations which accompanied the lectures are given in the form of a series of experiments at the end of each chapter. Some of these experiments are so simple that they may be carried out with ordinary household utensils, others require a few chemicals and simple apparatus which may be purchased at any drug store. Many of them require a fairly well equipped chemical laboratory, while others have been included which can be performed only by those who have considerable chemical training and facilities at their command. Most of the descriptive matter can be understood by the average intelligent reader although even here a knowledge of chemistry will enable the reader to comprehend the subject much more fully."

"Of the great need of a wider and fuller knowledge of the nature and functions of the food which is of such vital necessity to us, the author has the keenest realization. In an age when intelligence and knowledge are recognized as essential to the most efficient performance of even very simple tasks, it is surprising that most of us eat what we like, with very little thought of the ultimate result.

"The steel for our bridges and buildings is bought and sold on the chemist's certificate of its composition to the thousandths of percent. Foods are manufactured and sold on flavor and appearance, utterly regardless of composition or food value. The coal for our engines must be tested and analyzed, but the far more precious human organism is loaded with a heterogeneous mixture of fuel of unknown composition. We should not be surprised at low efficiency, inability to work, sickness, even the premature death of an organism which is given so little intelligent care. When an intelligent, well-informed public demands analyzed, tested foods, they will be better served by the food producer, manufacturer, and salesman; and if such food is consumed in the physiologically proper quantity and variety, there will be far less inefficiency, sickness, and mortality."

The subject is treated under the following heads: What is food?: what is pure food?: standard rations and the cost of food; milk; bacteria in milk; fats and oils; butter and its substitutes; meats; carbohydrates; candies; aniline dyes and other food colors; preservation of foods: fruits, jams, and jellies; fresh and canned vegetables; bread and the cereals; leavening agents; spices and condimental foods; flavoring extracts.

The author has written a very interesting book and one that can be recommended. The reviewer is a little sceptical as to the great importance of the calorific value of foods; but the author is quoting from standard authorities, so he cannot be held responsible.

One wishes also that the author might have given some explanation of the following paragraph, p. 61. "If an oil is kept at a low temperature for some time, it separates into two constituents, one of which is solid and the other liquid. The solid constituent can be separated by filtration from the liquid fat or oil. If the two constituents are allowed to remain together and the mixture warmed, the solid melts so that the oil resumes its original appearance. Its properties are not quite the same as before. It is a well-known fact that olive oil which has been frozen will not make as good a salad dressing as the unfrozen oil."

Wilder D. Bancroft

## THE THEORY OF EMULSIFICATION. I

BY WILDER D. BANCROFT

If two non-miscible or partially miscible liquids are shaken together vigorously, each tends to break into drops and to form an emulsion in the other. The emulsions thus formed are very instable and it seems probable that the presence of a third constituent is necessary to the formation of a stable or even of a fairly stable emulsion. Wa. Ostwald<sup>1</sup> has pointed out that it is theoretically possible to have two series of emulsions containing two non-miscible or partially miscible liquids, A and B. Since one of the liquids is practically always water, and since the other liquid is usually an oil, we can speak of water and oil instead of liquids A and B. In one of the two series referred to by Wa. Ostwald, water will be the dispersed phase while it will be the dispersing phase in the other. If we use the vernacular we shall say that water is present as drops in one series of emulsions and oil as drops in the other series. The physical properties of the two series of emulsions may differ considerably. If we are impregnating wood with an emulsion of water and creosote, the oil will come in contact with the wood if the water is present as drops suspended in the oil. If the oil is present as drops suspended in the water, the wood will be wetted first by the water and will consequently not take up the oil readily. If one dips a piece of filter paper into an oil-water emulsion in which the oil is present as drops, the filter paper becomes wetted with water and the oil drops run off. If the filter paper is dipped into an emulsion in which water is present as drops, we get an oiled paper from which the water runs off.

Wa. Ostwald points out that milk is an emulsion in which fat occurs in drops, while butter is an emulsion in which water is present as drops. He then proceeds to discuss the possible concentrations for which the double series of emulsions occur.

<sup>1</sup> Zeit. Kolloidchemie, 6, 103 (1910).

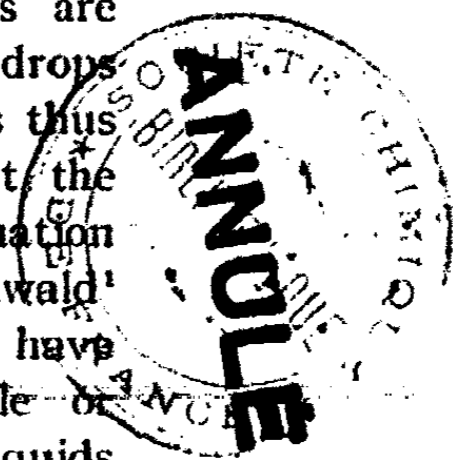

While his reasoning is inaccurate, it is interesting as showing how far astray one can go if one starts from slightly inaccurate premises.

"It seems at first as though the nature of the emulsion would depend on the relative amount of the two phases forming the emulsion. It is obvious [in Clifford's sense of the word] that with 98 percent water and 2 percent oil, one can only make an emulsion in which oil is present in drops. It is equally clear that we can only make the emulsion in which water is present as drops in case we start with 97 percent oil and 3 percent water. There is nevertheless an extended series of concentrations within which it is possible to have either constituent occur in drops depending on the way in which the emulsion is made. It is easy to prove stereometrically that this is possible. Although it is often not quite correct to do so, we will make the assumption that the drops in an emulsion are spherical and of equal size and that the dispersing phase changes to drops when the original drops come in contact.

"To take a concrete case we will consider oil emulsified in water. The water forms the dispersing phase and the oil the drops. If we keep on adding oil, the distance between any two drops of oil will become less and less until, finally, the oil drops will come in contact and will coalesce, forming the dispersing phase and breaking the water film into drops. This is one of the 'critical points' which we can calculate according to our assumptions. We find the second 'critical point' by emulsifying water in oil and by adding water until the oil changes from being the dispersing phase to being drops. If neither liquid affects the other, the two critical points must be situated symmetrically, which simplifies very much the calculation (based on our assumption). If the usual assumption is correct, that only the percentage composition counts, the two critical points must coincide at, and must occur at, 50 percent [presumably volume concentration]."



The author then calculates<sup>1</sup> that the double series of emulsions may occur from 25.96–74.04 volume percents. Although the author is careful to say that these limits hold only in case his assumptions hold, it is quite clear that he considers them approximately accurate and that he looks upon the range of about 48 percent as distinctly a first approximation. This is the more surprising because Pickering<sup>2</sup> had previously made an emulsion containing 99 volumes kerosene to 1 volume water in which the kerosene occurred in drops with the water as dispersing phase. One trouble with the theory is the postulate that the drops must all be the same size. It is probably very rarely true that all the drops are even approximately of the same size and nobody is interested in the limiting case of an emulsion prepared under such artificial restrictions. This however is not of much importance. The great difficulty with the theory of Wa. Ostwald is the double assumption that the drops in an emulsion are necessarily spherical and that they will coalesce before being forced out of shape. This might perhaps be true for mixtures of two pure liquids but even then it is of no interest if one cannot make even a semi-stable emulsion of them. The assumption is certainly not true for any actual emulsion because, in these cases, we always have a surface film of some sort which tends to prevent coalescence. Under these circumstances the drops may squash down until the space between them is only vanishingly small. Nobody knows what the real limiting value is.

In a gel we have drops of water in a net-work of the other phase. If we consider the other phase a liquid, a gel is merely a very viscous emulsion. I prefer to look upon a two-component gel as a limiting case of an emulsion in which we have one liquid and the emulsifying agent, while the concentration of the second liquid has become zero. That, however, is a minor matter. The important thing is that a dilute gel gives us some data as to the amount of the second

<sup>1</sup> Wa. Ostwald: *Zeit. Kolloidchemie*, 7, 64 (1910).

<sup>2</sup> *Jour. Chem. Soc.*, 91, 2002 (1907).



phase necessary to keep water or some other liquid in drops. As long ago as 1853, Crum<sup>1</sup> prepared an aqueous gel containing 1/600 alumina and 1/7500 sulphuric acid. Doubtless one could do better now; but this is good enough for the time being.

While the limits for the double series of emulsions, as calculated by Wa. Ostwald, are faulty owing to mistaken premises, this does not detract from the real value of the paper. He is the first, so far as I know, to lay stress on the existence of two over-lapping series of emulsions and the first to point out the possible technical importance of the two series. So far as I can see, it is theoretically possible to take any pair of non-miscible or partially miscible liquids and to make two series of emulsions over the whole range of concentrations by adding suitable third substances. One cannot yet tell whether it will be possible to find suitable third substances for every pair of liquids, but in any case, it ought to be possible to predict what the properties of the third substance should be. Before describing our own experiments, it has seemed to me desirable to give a detailed account of what is now known in regard to emulsions. This is the more necessary because I cannot find that anybody has ever even made an attempt to look up the literature and to explain the many curious observations which are on record. In spite of the wide-spread household use of some emulsions, there is no article on emulsion either in the *Encyclopaedia Britannica* or in *Watts' Dictionary of Chemistry*.

In the previously cited paper, Wa. Ostwald<sup>2</sup> describes his experiments on the two series of emulsions. Most of his experiments seem to have been made with a final mixture of sixty parts water and forty parts kerosene. The oil, or water as the case might be, was placed in a tall glass cylinder and the other liquid emulsified in it gradually by means of an electrically-driven stirrer. In this way a snow-white emulsion of kerosene and water was obtained which began

<sup>1</sup> *Jour. Chem. Soc.*, 6, 216 (1854).

<sup>2</sup> *Zeit. Kolloidchemie*, 6, 106 (1911).

to clear, on standing, at the top and at the bottom. When everything was clean, it was possible to note two fairly sharp menisci; the rate of movement of each meniscus was noted and plotted on coördinate paper.

Experiments with a shaking-machine gave no comparable results even though glass beads were added. Coloring with dyes or with iodine changed the whole nature of the phenomenon. Instead of two fairly sharp menisci, there was formed a thick creamy layer which lasted for days. This was really a first step towards preparing a stable emulsion, but Wa. Ostwald did not look at it in that light. He considered that he was dealing with complicated and superfluous phenomena.

While the first experiments went as Wa. Ostwald expected them to, there was trouble when the measurements were repeated. Careful tests finally showed that the trouble was due to the difficulty in cleaning the surface of the cylinders and the stirrer. Washing with hot water was quite insufficient. In order to duplicate results it was necessary to wash out the cylinders with benzene or some other volatile solvent for fats, to treat carefully with chromic acid mixture, and then to pass live steam through the cylinders for several hours.

The purified and dried surfaces were carefully covered with oil in case an oily emulsion (O) was wanted and with water in case a watery emulsion (W) was to be made. The other liquid was added and the stirring begun. "The short-lived emulsions had very different properties depending on whether the surface was water or oil. The oily emulsions separated very quickly into a lower layer of practically clear water and an upper, oil layer which consisted of a very fine and distinctly stable emulsion of a small amount of water as drops in a large amount of oil. With an oily emulsion the meniscus was convex. The walls of the lower part of the cylinder also had adhering drops of oil.

"The watery emulsions—the usual type—were very much more stable. They separated slowly into a practically

clear oil layer and a water layer containing finely-divided oil drops. This emulsion persisted a long time just as did the drops of water in the oil layer of the oily emulsion. The walls of the cylinder were clean and so was the meniscus."

Wa. Ostwald made a couple of rather interesting observations which he puts in a footnote and from which he apparently drew no conclusions. He poured oil into a carefully purified and dried cylinder, and then ran in the water drop by drop without stirring. He says that even with this very coarse emulsion one can recognize the appearance of the critical point. He did not, however, try the other experiment of running oil into the water, which probably would not have turned out as well. He did observe, however, that sometimes the change to oil as drops did not take place as scheduled and that the oil formed very thin films round the deformed drops of water. Even this did not shake his views as to an emulsion of water in oil being possible only when the volume concentration of the water was less than 74 percent. He considered the matter purely as a case of supersaturation and let it go at that.

According to Wa. Ostwald an emulsion of oil and water settles rapidly, forming two liquid layers, one of which is clear and the other turbid. He accounts for this by saying that when one has an oily emulsion the scattered drops of oil are made to coalesce by the stirrer while this is not the case with scattered drops of water. In other words an oily emulsion, with oil as surface liquid, tends to destroy drops of oil and to conserve drops of water while a watery emulsion, with water as surface liquid, tends to destroy scattered drops of water and to conserve drops of oil.

Wa. Ostwald<sup>1</sup> sums up his paper as follows:

(1) When the concentration of one constituent is increased continuously an emulsion must go through a critical point, where what has been the dispersed phase becomes the dispersing phase. Starting with the same constituents but.

---

<sup>1</sup> Zeit. Kolloidchemie, 6, 108 (1910).

at the other end of the series, increasing the concentration of the other constituent continuously will cause the emulsion to pass through a second, analogous, critical point.

(2) These two critical points do not coincide. Calculation shows that, as a first approximation, they overlap about 48 percent<sup>1</sup> [from 26–74 percent]. Anywhere within this range it is possible by special means to prepare two emulsions *having the same percentage composition but entirely different properties*.

(3) As a result of supersaturation phenomena this critical range can be extended and systems can be obtained consisting practically of two liquids, in which the outside phase (the dispersing one) occurs as an extraordinarily thin film around fairly coarse drops of the dispersed phase. The result is something like a foam with coarse air-bubbles.<sup>2</sup>

(4) The experiments showed the correctness of the first two conclusions and showed that the limiting critical concentrations for the two sets of emulsions can be determined by having the containing vessel completely wetted first by one constituent and then by the other.

(5) The fundamental influence of the nature of the surface upon the phenomenon is shown by the precautions necessary when one wishes to duplicate results, by the characteristic form of the meniscuses, and especially by the fact that when the two liquid layers separate, the constituent, which has been the external phase, retains drops of the other phase so as to form a fairly permanent, dilute emulsion, while the other constituent separates as a clear phase.

(6) These phenomena become intelligible in view of the macroscopic observation that wetted surfaces destroy the dispersity of that phase and conserve the dispersity of the other phase.

---

<sup>1</sup> The figure is actually given as 56 but was changed to 48 in the second paper, *Zeit. Kolloidchemie*, 7, 64 (1910).

<sup>2</sup> It is possible that there are more liquid-liquid foams than people realize at present and that such dispersed systems may be of considerable theoretical importance.

Quincke<sup>1</sup> discusses the stability of emulsions as follows:

“J. Plateau<sup>2</sup> first showed that many liquids seem to be more viscous at the surface than within the mass. It was found later by myself<sup>3</sup> and by Marangoni<sup>4</sup> that the surface of a liquid in contact with air became less mobile the moment a thin film of another liquid spreads over it. The same thing holds when a third liquid (soap solution) spreads out over the surface of contact between two such liquids as oil and water. The immobility or the permanency of the surface modified by the thin film of the third liquid is shown by the fact that any hole in the film is at once closed by the molecular forces because we have in the hole a clean surface of a liquid and consequently a greater surface tension than where the surface is contaminated by the film of the third liquid.

“For equal mobility of the surfaces a hole in the film will be closed more rapidly and the stability of the surface will be greater, the greater the difference.<sup>5</sup>

$$\alpha_{12} = (\alpha_{13} + \alpha_{32})$$

“An emulsion consists of a large number of spherical drops of fat dispersed through a watery liquid. Ordinary milk is an emulsion for instance. The smaller the drops of fat are, the greater the resistance as they rise through the denser, surrounding liquid. The smaller the drops of fat, the longer they remain floating in the surrounding liquid and the more perfect the emulsion. The emulsion is more permanent, the less readily the small drops of fat coalesce to form larger drops and the lower the rate with which the globules of fat rise through the surrounding aqueous liquid. The lower this rate, the less the density of the emulsion varies

<sup>1</sup> Wied. Ann., 35, 589 (1888).

<sup>2</sup> Mém. d. Brux., 37, 3 (1868).

<sup>3</sup> Quincke: Pogg. Ann., 139, 3 (1868).

<sup>4</sup> Nuovo Cimento, [2] 5, 239 (1872).

<sup>5</sup> [ $\alpha_{12}$  is the surface tension between oil (Liquid 1) and water (Liquid 2);  $\alpha_{13}$  between oil and the soap film (Liquid 3);  $\alpha_{32}$  between the soap film and water.]

from that of an actual solution of the fat in the surrounding liquid.<sup>1</sup>

“By shaking oil with soda or gum arabic solution, one can prepare emulsions which look like milk. When fatty oils are emulsified in soda solution, the coalescing of the fat globules is prevented by a thin film of soap solution,<sup>2</sup> any opening in which is at once closed by the molecular forces. In the emulsions as prepared by the druggists, each small globule of fat is separated from the aqueous solution by a film of gum arabic solution. The figures in Table I show that the surface tension between the fatty oils and the gum arabic solution is less than the surface tension of the fatty oils against water.

TABLE I  
Surface tension at the surface between

	oil and water	oil and gum solution
	$\alpha_{12}$ mg	$\alpha_{13}$ mg
Colza oil	1.564	1.474-0.415
Olive oil	2.296	1.491-0.020
Almond oil	2.370	1.237-0.487
Cod-liver oil	0.878	0.600-0.333
Castor oil	1.624	0.955-0.785

“After the oil and the solution of gum arabic come in contact, the surface tension of the surface separating the two decreases a good deal at once. In the first minute it falls off 10 percent and in the course of several hours it drops 35-50 percent of the original maximum value. This unusually rapid decrease appears to indicate a chemical compound which is formed from the oil or the free fatty acid in it by the action of the gum arabic solution. It spreads over the surface between the two liquids, covers the drops of oil, and keeps them from coalescing. The viscosity of the gum arabic

<sup>1</sup> Bondy: Pogg. Ann., 146, 323 (1865). F. Mach: Ibid., 126, 329 (1865).

<sup>2</sup> Quincke: Wied. Ann., 35, 562 (1888).

solution also checks the rise of the oil drops and therefore keeps them to some extent from coalescing.

"If one shakes together mercury, water and olive oil, there is formed a grayish white viscous mass, an emulsion of mercury, formed of many small globules of mercury, each one covered with a film of oil. According to my measurements, we have the following surface tensions:

Mercury		water	$\alpha_{12}$	=	42.58	mg
Mercury		oil	$\alpha_{13}$	=	34.19	mg
Oil		water	$\alpha_{32}$	=	2.30	mg

The force, with which a break in the oil film is drawn together, is a fairly large one,

$$\alpha_{12} - (\alpha_{13} + \alpha_{32}) = 6.09 \text{ mg}$$

As a matter of fact, such mercury emulsions last for months. Addition of acid destroys the film of oil and consequently the emulsion. Gray mercury salve is really an emulsion of mercury in viscous lard."

Quincke<sup>1</sup> has also something to say in regard to spontaneous formation of emulsions.

"During the process of digestion the first step in the assimilation of fat is the formation of an emulsion with the liquid in the intestine and this is facilitated by the presence of bile. W. Kühne<sup>2</sup> and Brücke<sup>3</sup> have called attention to the effect which the soaps, formed in the small intestine, have on the formation of emulsions. According to Brücke, rancid oil, which contains free fatty acids, forms perfect emulsions more readily than a neutral fat, when shaken with dilute aqueous solutions of white of egg, borax or sodium carbonate.

"Joh. Gad<sup>4</sup> first made the interesting observation that when drops of oil contain free fatty acids, they form perfect emulsions by mere contact of the drops with alkaline liquids

<sup>1</sup> Wied. Ann., 35, 594 (1888).

<sup>2</sup> Physiol. Chemie, 129 (1866).

<sup>3</sup> Sitzungsber. Akad. Wiss. Wien, 61, II, 362 (1870).

<sup>4</sup> E. du Bois Reymond: Arch. Anat. Phys., 1878, 181.

and without any mechanical shaking. This phenomenon can be shown particularly well with a drop of cod-liver oil in 0.25 percent of soda solution. The ease of emulsification depends on the amount of acid, the viscosity of the oil, the concentration of the soda solution and the solubility, in the dispersing medium, of the soaps formed from the fatty acids. The solubility of the soaps can be so changed by the addition of sodium chloride and bile that the conditions are more favorable to the formation of emulsions. With viscous castor-oil no formation of emulsions could be observed.

“When emulsions were formed, tentacles developed on the drops of oil, the changes of shape and the movements being very like those of an *Amoeba*. Later, smaller drops of oil broke away and these were to some extent emulsified further.”

“When the oil comes in contact with the soda solution, a solid soap is formed by the action of the alkali on the free fatty acid contained in the oil. In time a part of this soap dissolves in the surrounding aqueous solution. When the liquid soap solution comes in contact with the oil, it spreads out suddenly on the interface of oil and water, carrying with it the undissolved particles of soap and the adhering masses of oil. In this way threads of oil are drawn out into the aqueous solution. These threads of oil have a tendency to change so as to present the smallest surface and they therefore break up into larger or smaller spherical drops just as a stream of water in air breaks into larger or smaller drops. The formation of drops is retarded to some extent by the solid or liquid soap either previously present or freshly formed. This tends to increase the length of the oil threads and to decrease the size of the resulting drops of oil. Through the spreading out of the soap solution, fresh surfaces of oil are brought in contact with the soda solution, and new amounts of soap are formed which then dissolve and spread out as before.

“This periodical spreading of the soap solution over the interface of the oil and water does not take place simultane-



ously at all points of the surface. It is connected with the previously described eddies<sup>1</sup> inside the two liquids. These draw the aqueous solution and especially the viscous oil toward the vortices, thus producing the amoeba-like movements at the edge of the mass of oil. When the oil drops split off, they form the emulsion. With an average value for the viscosity of the oil and for the rate of spreading at the interface of oil and aqueous solution, the eddies and the number of drops of oil formed will be especially large. The phenomena can be produced with films of dilute soap solution only a few millionths of a millimeter in thickness, and an incredibly small amount of solid soap is sufficient.

“The free fatty acid to form the soap is nearly always present in the oil and is brought to the surface by diffusion. In the liquids in the intestines, the free fatty acid can be formed by the action of the pancreatic juice, while, in the open air we get it by the action of carbonic acid on a neutral alkali oleate.

“If soap is formed too rapidly, the surface between the oil and the aqueous solution becomes covered with a membrane of solid soap. The surface ceases to be readily mobile and the spreading out, with its consequences, is either retarded or prevented entirely, just as the formation of vapor is either retarded or prevented in the Leidenfrost experiment where one pours water on a white hot metal.

“The motion of the oil drops, and the formation of emulsions, ceases also if the spreading out does not occur, owing to too little soap being formed or to the soap being dissolved too rapidly by the dispersing liquid. In the latter case each small amount of soap will spread out as a soap solution, but the energy of the spreading out will not be sufficient to start violent eddies and to cause particles of oil to split off. When the water in a mill stream is low, the mill wheel will not turn if the water is allowed to run down in drops, whereas work can be obtained if the water is dammed back and then allowed to flow out rapidly.

<sup>1</sup> Quincke: *Wied. Ann.*, 35, 562 (1888).

"When the oil drops, swimming on a soda solution, are covered with a membrane of solid soap, this can be dissolved by an aqueous solution of ox-bile. The bile may aid in the spontaneous formation of emulsions within the animal if the solid soap at the surface between oil and soda solution dissolves too slowly. It may check the formation of an emulsion in case it causes the solid soap to dissolve too rapidly. Both these phenomena have actually been observed by Gad."

In a later paper, Quincke<sup>1</sup> discusses the spontaneous formation of bubbles and foam with salts of oleic acid. This is really the case of an emulsion of air in water, which is not our problem strictly speaking; but it throws so much light on the behavior of the oleates in the case of emulsions of two liquids that I quote from it without further apology.

"Up to now very little work has been done on the alkali salts of oleic acid. According to Heintz<sup>2</sup> the potassium, sodium and ammonium salts of oleic acid form, with small amounts of water, slimy or gelatinous masses which are soluble in a little hot water and in alcohol. Addition of much water decomposes these salts into free alkali and acid salts, these last precipitating. Neutral potassium oleate (15 parts caustic potash and 85 parts oleic acid) takes up moisture from the air; neutral sodium oleate does likewise, but not to the same extent.<sup>3</sup> Potassium bioleate is a slimy or gelatinous mass, soluble in alcohol and insoluble in water, by which it is not decomposed.

"I have studied the behavior of the instable and easily decomposed oleates either in an ordinary test tube or under the microscope in a watch-glass which was filled with pure water and was covered in the usual way with a thin cover-glass. By means of a pointed, fire-polished glass rod the oleate was placed in the middle of the under side of the cover-glass, which latter was then set down upon the water of the watch-glass. When necessary, a slow stream of liquid was

<sup>1</sup> Wied. Ann., 53, 598 (1894).

<sup>2</sup> Zoochemie, 439 (1853).

<sup>3</sup> Löwig: Chemie organ. Verbindungen, 2, 203 (1846).

made to flow between the glasses, the water being introduced at the edge of the cover-glass and drawn off by means of a strip of filter paper at the opposite side.

"Sometimes dyes were added to the water so that we could test the acid or alkaline nature of the oleates under consideration. The dye must not make the liquid surface immobile and it must give a very intense coloration so that the smallest particles can be detected. Henna and litmus do not give a sufficiently intense coloration. I have usually used methylene blue or hectograph ink, or an alcoholic solution of phenolphthaleine which is colored an intense red by alkalis.

"The neutral potassium, sodium and ammonium oleates were prepared by heating oleic acid with usually a 10 percent solution of the alkali in question. The alkali was added gradually until the alcoholic solution of phenolphthaleine began to show a reddish color. These neutral salts are soluble in alcohol. When the solution is evaporated on the water bath or is cooled, the salts precipitate as solid substances, occasionally in the form of small, rather instable crystals. These salts form slimy or gelatinous masses when treated with a little water. With more water an acid salt precipitates, while free alkali remains in solution.<sup>1</sup>

"On adding a few drops of an alcoholic solution of phenolphthaleine to a dilute aqueous solution of a neutral alkali oleate, a red color is always obtained. If we heat the slimy masses of neutral alkali oleates, dissolved in a very little water, red streaks often appear and gradually disappear again. This proves that decomposition takes place here and there; but that the neutral salt is formed again later.

"On long standing in contact with water the acid salts break down into oleic acid, which separates in small liquid globules and rises to the surface of the liquid, and into a slimy or gelatinous mass of neutral oleate dissolved in water. This

<sup>1</sup> According to the recent investigations of Krafft and Stern [Ber. chem. Ges. Berlin, 27, 1755 (1894)] no basic oleates are formed.

slimy mass dissolves in more water to a mobile liquid, oleic acid precipitating.

"While oleic acid decomposes aqueous solutions of alkali carbonates, forming oleates, these oleates are also decomposed by carbon dioxide when this gas is passed through a slightly turbid and originally neutral solution of one of these salts. The solution clouds at once through precipitation of solid particles of sparingly soluble acid oleates. After a few hours globules of oleic acid collect on the surface of the liquid. If crystals or solid particles of sodium or potassium oleate are precipitated by water and then suspended in water, they become less dense if carbon dioxide is passed into the solution and they collect at the surface of the liquid, presumably carried up by the less dense oleic acid. At the same time there is also formed a readily soluble oleate which spreads out over the surface between air and water, dragging with it the soap crystals suspended in the water, and rising several centimeters up on the wetted wall of the test tube.

"When much alkali is added to a little oleic acid, we usually get oleates readily soluble in water; with a small amount of alkali and much oleic acid we usually get acid oleates which are sparingly soluble or insoluble in water. Crystals or solid masses of neutral potassium, sodium or ammonium oleate are soluble to a considerable extent in pure oleic acid, whereby the density of the latter may be increased until it is denser than water.

"Dry oleic acid remains colorless when placed in contact with dry methylene blue. On the other hand oleic acid takes methylene blue out of an aqueous solution of the dye. In capillary tubes of 0.5–2.0 mm diameter were sucked up water containing methylene blue (1/500, 1/5000, 1/50000) and then oleic acid in such a way that equal lengths of each liquid were in contact. The tubes were protected from the action of light by a metal case. Oleic acid containing dissolved potassium, sodium or ammonium oleate takes up the blue dye faster than does pure oleic acid. Under the influence of light the blue color disappears in pure oleic acid

more rapidly than in oleic acid containing alkali oleates. Even in the latter there is a marked disappearance of the color under the action of intense light.

"Sodium oleate also takes methylene blue out of an aqueous solution of the dye, assuming a deep blue, greenish blue or whitish blue color depending on whether the salt contains an excess of acid, is neutral, or contains an excess of alkali. The absorption spectrum of an aqueous solution of methylene blue shows two dark bands in the red and yellow at  $600 \mu\mu$  and  $606 \mu\mu$ . The absorption spectrum of oleic acid which has taken up methylene blue from water shows the two bands displaced towards the blue, the more refrangible band being faint or even non-existent. Thus one finds either two bands at  $657 \mu\mu$  and  $571 \mu\mu$  or one band at  $652-642 \mu\mu$ . Oleic acid containing dissolved potassium, sodium or ammonium oleate shows one dark band at  $654-641 \mu\mu$  or also at  $596$  and  $522$  with sodium oleate;<sup>1</sup> and two bands running together between  $640$  and  $632$  with ammonia. In this last case the band towards the red is darker than the one towards the blue.

"In the absorption spectrum of aqueous solutions of methylene blue the dark band in the yellow is lacking when there is sodium oleate in the water. The dark band in the red spreads out toward the blue end more and more alkali and the less oleic acid there is in the solution. These color changes with methylene blue make easy the detection of the decompositions which take place when alkali oleates are added to water.

"Oleic acid containing alkali oleates, when placed in a watch-glass under a cover-glass, also takes more methylene blue out of an aqueous solution of the dye than does pure oleic acid and takes it out more quickly.

"If oleic acid containing an alkali oleate be placed on the under side of a cover-glass and be brought in contact with water in a watch-glass, colorless spheres will form in the

<sup>1</sup> [It is not clear just what the author means by this.]

course of a few hours, a phenomenon which does not take place with pure oleic acid. These spheres contain either liquid or double-refracting crystals. The optical axes of these crystals are chiefly arranged radially, because an examination with crossed Nicols under a polarization microscope showed a dark cross parallel to the plane of polarization of the prism, and this cross does not change its position when the spheres are rotated. Such spheres, filled with liquid or with radially arranged crystals, occur if a small crystal of pure neutral sodium oleate is left for a day in contact with water under a cover-glass separated from the watch-glass by two strips made from a cover-glass. The neutral sodium oleate gradually decomposes under the action of water. There is formed liquid oleic acid, soluble alkali or soap, and a new oleate which is more strongly doubly refractive than the original neutral salt and which perhaps contains water of crystallization.

"For these experiments I was able to use pure oleic acid and pure crystals of neutral sodium oleate which I owe to the goodness of Professor Krafft. Commercial, ostensibly pure, oleic acid and the alkali oleates prepared therefrom behaved practically like the pure substances. There was one exception in the case of an ostensibly pure oleic acid which took up methylene blue extraordinarily slowly from an aqueous solution of the dye; but which very quickly became colored a deep blue when neutral alkali oleates were added.

"Slightly blue-colored oleic acid drops, containing ammonia could be decolorized by the action of dilute caustic ammonia. After long standing in contact with water, the blue color reappeared, probably because the water had again taken the ammonia from the oleic acid.

"When oleic acid, containing potassium, sodium or ammonium oleate, is brought in contact with water, a solid film of acid oleate forms on the surface. After long contact with water this solid film breaks down into drops of oleic acid, solid particles of acid oleate, and a slimy, gelatinous mass of neutral alkali oleate in which small and large drops of

oleic acid are suspended. The solid particles of the acid oleates often appear as feathery clumps of crystals and seldom as fibrous bands of crystals. The optical axis lies parallel to the long axis of the crystals. The needles dissolve in water more readily than the ribbon-shaped ones.

"On long standing in contact with water the gelatinous masses form bubbles, spherical in shape and not over 0.2 mm diameter, the surfaces being either solid or liquid. The solid walls of the spherical bubbles are colored deep blue when the water contains methylene blue. They therefore consist of liquid oleic acid containing dissolved alkali oleate and methylene blue, and covered with a solid film of acid oleate through contact with water. Many oleic acid drops or bubbles are not colored blue by contact with water containing methylene blue because this solid film of acid alkali oleate checks the taking up of the dye.

"Many, even hundreds, of these bubbles may hang together or be piled up one upon another so as to form small or large masses of foam with liquid or solid films consisting of liquid oleic acid or of solid acid oleates. In these films there are numberless, small, lenses or drops of oleic acid. If the solid walls dissolve owing to the prolonged action of water, they are replaced by new films of liquid oleic acid on which the, now mobile, drops of oleic acid are drawn together by capillarity to form compact groups of hundreds or more, just as masses of foam run together on the surface of the water.

"These mobile films throughout the mass of foam may, when forming, give rise to new bubbles or may form new hollow spaces which fill with aqueous liquid. The films of liquid oleic acid may also collapse if a freshly-formed soap solution spreads out over them. Then several bubbles unite to form one and draw the adjacent slimy masses or drops of oleic acid with them. Occasionally the oleic acid sheaths to the drops or the films in the mass of foam are so thick that they can easily be seen under the microscope. Often, however, the films are invisible even under the greatest magnifica-

tion. Their presence can be detected by the fact that they offer a resistance to flowing masses of liquids and change their direction. They can also be detected from the fact that the small globules of oleic acid (diameter 0.01–0.001 mm or even less) are distributed over spherical surfaces or are displaced along them and move in circular or elliptical paths. When the mobile and invisible films contract under the influence of capillary forces, they may be drawn, together with the globules of oleic acid suspended among them, in the opposite direction to the flow of the water under the cover glass.

“These films and the drops of liquid oleic acid of course contain alkali oleates; they take up methylene blue from the water, thereby becoming colored dark blue and more easily recognizable.”

“The flow of water may roll the hollow spheres with liquid or solid surface over the watch-glass or the water may flow by the bubble if the latter is checked in its course. In this way eddies are set up in the oleic acid covering to the bubble and in the bubble itself so that the solid grains, the oleic acid globules, and the small bubbles inside and on the surface of the bubble move round in a curious way. These movements, due to eddies, are similar to those which I have previously described.

“The formation of the spherical bubbles with solid or liquid walls may easily be accounted for. Acid alkali oleates are readily soluble in oleic acid and only slightly so in water. They are therefore less soluble in oleic acid containing water than in the anhydrous acid. When placed in contact with water, oleic acid, containing dissolved alkali oleates, therefore becomes covered with a solid film of acid alkali oleate. If the oleic acid, containing dissolved oleates, remains a long time in contact with water and takes up water, we get a precipitation at many points within the oleic acid of particles of oleates (perhaps containing water of crystallization) which

<sup>1</sup> Quincke: *Pflüger's Archiv*, 1879, 135; *Wied. Ann.*, 35, 580 (1888).



draw in more water, thereby forming hollow spaces bounded by spherical surfaces, with a diameter of 0.04 mm or less, and filled with an aqueous solution.<sup>1</sup> With pure oleic acid these hollow spaces either do not form at all or form very slowly as the result of an accidental absorption of alkali from the air (NH<sub>3</sub>) or from the watch-glass or cover-glass.

"If the precipitation of the particles of soap and the formation of hollow spaces result from water diffusing into the liquid oleic acid coating of a spherical bubble, there are formed numerous, small, hollow lenses filled with soap solution and bounded by a thin film of oleic acid. These lenses are distributed through the oleic acid coating of the original large bubble. When the concentration of the soap solution in the hollow lenses becomes sufficiently low, there is formed solid acid oleate, and the film of oleic acid on the surface becomes solid and rigid. If the further action of water dissolves the outer half of the coatings of the small lenses, there is left a skeleton of solid soap with concave hemispherical pock-marks."

Donnan has interested himself for a number of years in the theory of emulsions. In a paper on soap emulsions<sup>2</sup> he says:

"The formation of emulsions with fatty oils and alkaline liquids is a phenomenon well known to the physiologists. So far as I know, this subject has never received a quantitative treatment, and there seems to be no general theory of the subject. In this paper I have tried to go into the matter and to contribute something towards the theory of the phenomenon. The problem is an especially interesting one because it will probably lead some day to a rational theory of colloidal solutions. The formation of these emulsions takes

---

<sup>1</sup> [When the author speaks of hollow spaces, bubbles and foam, he is apparently using these words in a unusual sense, because he does not seem to mean that there is any air dissolved in his solutions. Most people would speak of drops and emulsions rather than of bubbles and foam. The author's hollow spaces filled with liquid are really drops of liquid around which films have formed.]

<sup>2</sup> *Zeit. phys. Chem.*, 31, 42 (1899).

place very readily if one pours olive oil or colza oil over an aqueous solution of caustic potash, soda or ammonia. If the beaker is shaken gently, there is formed at once a milk-white liquid. This phenomenon can be followed quantitatively by means of a modification of the ordinary viscosimeter pipette. The pipette is filled with the oil to be studied and is dipped into the alkaline solution. Since the drops of oil rise, the lower end is bent round..... The pipette is filled with oil a little above the upper mark, the stop-cock is closed, and the outer walls of the pipette are cleaned. The pipette is then dipped into the alkaline solution and the surface of the oil brought exactly to the upper mark. The drops of oil which may still be clinging to the end of the pipette are either removed or estimated. The oil is then allowed to run out down to the lower mark and the number of drops counted. It is desirable to keep the levels as nearly constant as possible in a series of comparative measurements. The following data were obtained in this way.

COMMERCIAL COLZA OIL AND CAUSTIC SODA

g.-Mol NaOH per liter	Number of drops
0	88
0.0005	115
0.0008	213
0.001	306
0.0011	430
0.0013	Stream

Similar results were obtained with sodium carbonate.

COMMERCIAL COLZA OIL AND SODIUM CARBONATE

g.-Mol NaOH per liter	Number of drops
0	88
0.0005	105
0.00075	175
0.001	236
0.00125	300
0.0015	477

From this we see that the decrease in the surface-tension plays an important part in the phenomenon and that this decrease increases very rapidly with increasing concentration of the alkali. The action of the sodium carbonate depends probably on its hydrolytic dissociation.<sup>1</sup> Other sodium salts, which undergo hydrolysis in aqueous solution have a similar action. Borax is a good instance of this.

"This decrease in the surface tension is due to the formation of a soap at the surface. As a matter of fact, freshly-prepared soap solutions increase the number of drops in a similar way; but the result is not conclusive, because it is difficult to distinguish between the influence of the soap and the action of the alkali formed by hydrolysis. It is however known and will be confirmed by later experiments that the formation of soap at the surface is the cause of the phenomenon. At first one might be inclined to suspect a surface saponification of the glyceride; but most of the text-books on physiology state that the natural oils almost all react acid and that the emulsifying action of the alkaline liquids is the result of the formation of soap by simple neutralization.

"The data obtained with the viscosimeter pipette are in perfect agreement with this view. A neutral olive oil was prepared in the way recommended by Neumeister, heating the commercial oil for a short time with a little barium hydroxide solution, extracting with ether, drying the ethereal solution and driving off the ether first on the water bath and then over a free flame under diminished pressure. Oil, so purified, differs from the commercial oil in reacting entirely neutral with phenolphthaleine. Dilute alkali no longer has any effect as is shown by the following measurements with the pipette:

	No. drops in water	No. drops in N/1000 NaOH
Commercial oil (acid reaction)	58	331
Purified oil (neutral reaction)	55	58

<sup>1</sup> [If this were true, we should have over 70 percent hydrolysis, which is not the case.]

In the case of the neutral oil the difference between the number of drops in the two liquids is negligible.

"In order to exclude completely the possibility of the formation of soap by a surface saponification, the further experiments were made with solutions of fatty acids in a neutral hydrocarbon of the paraffin series. We get here exactly the same phenomena as with the acid fatty oils.

PURE HYDROCARBON

	No. drops
In water	47
In N/100 NaOH	52.7
Hydrocarbon + 0.6 percent commercial stearic acid	
	No. drops
In water	48.5
In N/1000 NaOH	320.0

"This solution also forms an emulsion instantaneously with dilute caustic alkali as appears from the following data.

Concentration of solution	Number of drops in		
	Water	N/2000 NaOH	N/1000 NaOH
0.2 g. stearic acid per 70 g.	41	95	140.0
0.4 g. stearic acid per 70 g.	44.5	162	288.0

"The lower fatty acids have no such action. This is brought out clearly by the following comparative measurements. The solutions all contained 0.5 gram of the acid in question, dissolved in 70 gram hydrocarbon.

Acid	Number of drops in	
	Water	N/100 NaOH
Formic acid (C <sub>1</sub> )	34	37
Acetic acid (C <sub>2</sub> )	38	38
Butyric acid (C <sub>4</sub> )	38	35
Caprylic acid (C <sub>8</sub> )	44	47
Lauric acid (C <sub>12</sub> )	43	82

"It is only with the lauric acid that we get a marked increase in the number of drops. We are dealing with a peculiar action of the higher fatty acids,<sup>1</sup> such that the formation of salts of these acids lowers the surface-tension at the surface of contact between the two liquids very much."

"It is clear that solutions of soaps present certain peculiarities. This was previously established by the interesting experiments of Krafft.<sup>2</sup> If we compare the preceding results with Krafft's determinations of the molecular weight by the boiling-point method, we see a marked parallelism.

Sodium salts	g. salt/100 g. water	Apparent M. wt. Formula wt.
Sodium acetate	25.2	0.5
Sodium propionate	19.8	0.5
Sodium nonylate	20.4	1.58
Sodium laurate	16.1	2.28
Sodium palmitate	25.0	ca. ∞
Sodium stearate	27.0	ca. ∞

"These measurements are perhaps not entirely trustworthy<sup>3</sup> as determinations of molecular weights; but they measure some peculiarities of soap solutions. Krafft accounts for this peculiarity by assuming the colloidal nature of these solutions; but Kahlenberg and Schreiner reject this hypothesis and their objections seem to be very well taken. On the other hand, their explanation of Krafft's boiling-point experiments is unquestionably wrong. They assume a very high surface-tension for soap solutions. Just the reverse was proved long ago to be the case by Lord Rayleigh's<sup>4</sup> experiments. The boiling-point experiments of Krafft are undoubtedly vitiated by the marked foaming

<sup>1</sup> One might be inclined to attribute the effect to a decreased solubility or rate of solution of the soaps; but if one uses a barium hydroxide solution or a concentrated caustic potash, thus producing solid films, no emulsion is formed.

<sup>2</sup> Ber. Chem. Ges. Berlin, 27, 1747 (1894); 28, 2556 (1895); 29, 1328 (1896).

<sup>3</sup> Kahlenberg and Schreiner: Zeit. phys. Chem., 27, 552 (1898).

<sup>4</sup> Proc. Roy. Inst., 13, 85 (1890).

of the soap solutions, just as Kahlenberg and Schreiner say; but they are in error as to the cause of foaming. The theory of this phenomenon has been given by Lord Rayleigh. He comes to the conclusion that pure liquids do not foam and that we get the phenomenon of foaming only when the liquids contain certain impurities. Thus slight additions of alcohol or acetic acid to water are helpful. Substances like glue, gelatine, soap and saponin have an extraordinary effect even when present in very small quantities. Lord Rayleigh points out that the stability of a bubble depends on the presence of impurities which lower the surface-tension because the flowing down of the liquid produces concentration changes, and the accompanying changes in the surface-tension act against the force of gravity. The marked action of very small amounts (impurities) of certain substances such as soap and saponin are due to the concentrating of these substances in the surface film. Such a concentrating in the surface film has actually been shown experimentally for soap solutions in the recently published work of D. H. Hall.<sup>1</sup> In view of all these observations and of my own experiments, the following outline of a theory of soap emulsions (and perhaps of all emulsions) seems justifiable.

“The soap concentrates in the surface film between the oil and the liquid.<sup>2</sup> One can picture the equilibrium as follows. In consequence of its power of lowering the surface tension, the soap has a tendency to concentrate in the surface because that causes a decrease in the free energy of the system. Yet one must not forget that 1 gram of substance in the surface film does not have the same entropy and energy as when within the liquid and it is consequently possible that the postulated decrease in the free energy may be compensated by an increase due to this other factor. As a matter of fact, if there is such a compensation, there will be no increase

<sup>1</sup> Proc. Roy. Dub. Soc., 9 (N. S.), Part I, No. 10, p. 56.

<sup>2</sup> Analogous phenomena are the condensing of gases on glass surfaces and the removal of dissolved substances from solutions by charcoal, silicic acid, etc.

in the surface concentration. There is therefore an equilibrium between the more concentrated surface film and the more dilute liquid inside. The effectiveness of the active substance is increased enormously by the piling up in the surface film. In this way the work necessary to increase the common surface is decreased very much and the formation of small drops is consequently made easier. We must consider each of these small drops as surrounded with a more concentrated surface film.

The stability of the emulsion depends on the fact that this surface film tends to prevent a coalescence of the oil drops. If we consider the way in which two drops unite, the first stage will be something like that represented by the dotted lines in Fig. 1. In this region, where the decrease

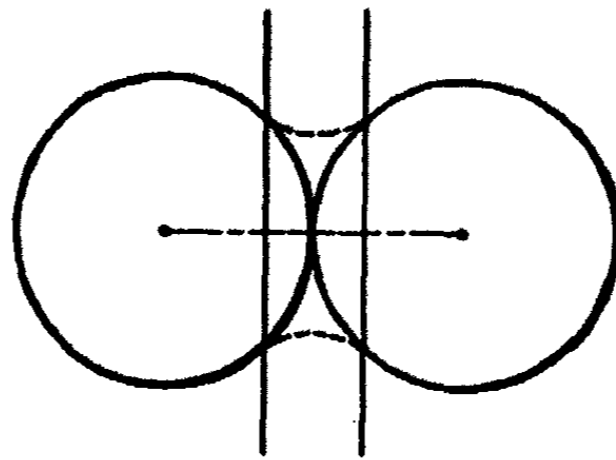

Fig. 1

in the surface first takes place, the concentration in the surface film becomes momentarily greater and the surface-tension consequently less than anywhere else in the whole surface. Consequently capillary forces are set in motion which tend to tear this portion apart and thus to prevent the coalescence.

“If this view is sound, emulsions are very similar to foams and it would perhaps not be too rash to consider foam as a sort of air-emulsion. I have only spoken of soap emulsions; but I should like to call attention to the interesting paper by Moore and Krumbholz<sup>1</sup> in which they point out the powerful emulsifying action of alkali-albumen and acid-albumen on olive oil.”

<sup>1</sup> Proc. Physiol. Soc. London, 54 (1898).

"In a later paper<sup>1</sup> Donnan gives some measurements on the relation between the concentration of solutions of sodium salts of the fatty acids and the surface-tension." The salts up to sodium oenanthylate are relatively inactive and do not differ much in action one from the other. The sodium salt of caprylic acid is the first to show a marked action in decreasing the surface tension. From here on the effect increases rapidly with increasing molecular weight. In this matter of the lowering of the surface-tension, the sodium salt of caprylic acid seems to form almost a critical point in the series of sodium salts of the normal, saturated fatty acids.

"The irregularities observed with the salts of the lower acids are possibly due to the experimental error in the method of measurement. These results permit of an interesting comparison with Krafft's determinations of molecular weights.<sup>2</sup> He found abnormal (too high) molecular weights beginning with the sodium salt of pelargonic acid. In Krafft's experiments this was true only for very concentrated solutions while our measurements were on dilute solutions exclusively. This may perhaps be explained on the ground that Gibbs' law calls for a marked increase of concentration (adsorption) of the salt in the surface separating the oil from the aqueous solution, and this increase in concentration takes place in our experiments with the salts of the higher acids. There is also an interesting observation by Mayer, Schaeffer and Terroine<sup>3</sup> to the effect that the alkali salts of the lower fatty acids form homogeneous, optically empty, solutions while ultramicroscopic suspensions are to be observed in the neutral solutions of salts of capronic, caprylic and lauric acids. When considering aqueous solutions of the alkali salts of the normal saturated fatty acids, we are not far from the truth if we say that 'soapiness' begins about with caprylic acid and is clearly marked with lauric acid. We shall have occasion to return to this very important and interesting point.

<sup>1</sup> Donnan and Potts: *Zeit. Kolloidchemie*, 7, 208 (1910).

<sup>2</sup> Krafft: *Ber. chem. Ges. Berlin*, 29, 1328 (1896).

<sup>3</sup> *Comptes rendus*, 146, 484 (1908).



"It was found rather difficult to obtain reproducible and comparable values for the emulsifying powers of emulsion. After many experiments, we finally adopted the following method. A measured amount of the solution to be studied, together with a measured amount of the hydrocarbon oil (lubricating oil from Henry Wells Oil Co.), was placed in a cylindrical flask of glass or better of quartz<sup>1</sup> which had been washed thoroughly with steam. In comparable experiments the volumes taken, and also the form and dimensions of the vessel, must be exactly the same. Both the quartz and the glass vessels had ground-in stoppers and the well-closed flasks were shaken vigorously at constant temperature. For this purpose we used a specially constructed shaking machine. It is of course necessary that the style, strength and time of shaking shall be exactly the same in all cases. In our experiments we always took so much oil that a relatively large amount remained unemulsified after the shaking. We found that shaking for 16 hours was sufficient to give the maximum amount of emulsification possible with our apparatus. The flask was then allowed to stand for 2 hours. After these operations, one found three layers in the flask. The uppermost one was a yellow layer of clear, coherent oil; the middle one was a white, thick 'oil-cream,' while the lowest one was a very dilute emulsion. The flask was shaken carefully for a minute in order to mix the two emulsion phases uniformly (the upper, creamy emulsion and the lower dilute emulsion) without disturbing the uppermost, coherent oil layer too much. The flask was allowed to stand for a minute so that the uppermost, coherent oil layer might form again and then 10 cc of the lower, uniformly white, emulsion was pipetted off, care being taken to prevent any portions of the coherent oil layer being carried up into the pipette. The contents of the pipette were analyzed as follows. We coagulated the oil with a little alum, shook the oil out with ether, poured the ethereal solution into a crystallizing dish,

<sup>1</sup> Vessels of quartz gave us better results than those of glass. With the latter, very irregular results were often obtained.

let the ether evaporate, and dried the oil to constant weight by gentle heating. In this way it was possible to determine the percentage amount of oil emulsified. The experimental errors are pretty large and it is necessary to do each experiment at least four times in order to get a safe average.

“The results of these measurements were that the sodium salts of the lower fatty acids give no emulsions at all. Even with the sodium salts of pelargonic and capric acids, the emulsions were so dilute that our measurements were not sensitive enough to permit of any determinations. It was only with the sodium salts of lauric and myristic acids that we obtained satisfactory emulsification.”

EMULSIFYING POWER OF

Sodium laurate		Sodium myristate	
Conc.	Percent oil emulsified	Conc.	Percent oil emulsified
N/50	0.6	N/200	6.5
N/100	0.7	N/300	14.9
N/150	4.5	N/600	1.0
N/200	7.2	—	—
N/300	9.6	—	—
N/600	2.2	—	—

“The most important conclusion to be drawn from these data is that there is an optimum concentration for each salt, at which the salt has the maximum emulsifying power. It is evident that the salts must have an action adverse to emulsification, namely a coagulating or ‘salting-out’ action. It is probably the positively charged sodium ions which have a coagulating action on the negatively charged drops of oil. We can now explain why the sodium salts of caprylic, pelargonic and capric acids have no appreciable emulsifying power although these salts lower the surface tension considerably. With these salts the lowering of the surface tension and the resulting emulsifying power cannot counterbalance the coagulating action of the sodium ions.<sup>1</sup>

<sup>1</sup> [In this form this seems more like a suggestion than an explanation.]

"It is now clear why the washing power, the characteristic of soap, appears only in the salts of the higher acids and is probably first noticeable with the alkali salts of lauric acid. The washing power is connected closely with the emulsifying power and this latter depends chiefly on the lowering of the surface tension and on the accompanying increase in surface concentration. The emulsifying power becomes noticeable however only when the lowering of the surface tension is sufficient to counterbalance the salting-out action of the sodium ions. With the sodium salts of lauric and myristic acids, the 'salting-out' action is relatively so important that the maximum emulsifying power occurs at very low concentrations.<sup>1</sup> The experiments of W. Spring are of great importance in connection with this and, to a certain extent, confirm our views. Spring<sup>2</sup> found that there was a certain concentration of soap which had a maximum effect in making stable a suspension of lampblack. This optimum concentration was about 1 percent. In a 2 percent soap solution the lampblack settled about as quickly as in pure water. He found also that a suspension of lampblack, which had been made stable by the addition of soap, passed readily through a filter-paper, which points to an adsorption or a surface concentrating of the soap.

"We come finally to the question why the sodium salts of the higher fatty acids lower the surface tension at the surface between oil and water. At present there is nothing very definite to be said in regard to this and yet we wish to call attention to the fact that F. B. Kenrick,<sup>3</sup> in an excellent paper, has shown that those very substances, such as amyl alcohol and butyric acid, which lower the surface-tension between liquid and air very much even when present in minute

<sup>1</sup> The comparison with the results of Krafft suggests the possibility that the action of the salts of the higher fatty acids may be due in part to the fact that, owing to their colloidal properties, the concentrating in the capillary surface gives rise to a very viscous or gelatinized surface film.

<sup>2</sup> Rec. Trav. chim. Pays-Bas, 28, 127 (1909); Zeit. Kolloidchemie, 4, 161 (1909); 6, 11, 109, 164 (1910).

<sup>3</sup> Zeit. phys. Chem., 19, 625 (1896).

quantities, are also the ones which have a marked action on the electrical potential difference between water and air. By means of a whole series of accurate observations Kenrick has proved the complete parallelism of the two phenomena. We may therefore perhaps assume that in the case of the surface between hydrocarbon oil and water, the active substances bring about marked changes in the potential difference which undoubtedly exists. It is perhaps possible that in both cases the electrical phenomenon is the primary one, so to speak, and that a selective adsorption of the ion of a fatty acid increases the potential difference and decreases the surface tension. It is inadvisable to say more than this at the present time. We need more experiments<sup>1</sup> to throw light upon the subject."

In a paper from Donnan's laboratory Lewis<sup>2</sup> discusses another side of the general theory. He worked with an emulsion of a mineral oil in water because that eliminated secondary reactions. He appears not to have added any third substance intentionally which perhaps accounts for his only getting weak emulsions. As was the case with Donnan, he ignores the practice of the pharmacists of adding the oil or the water little by little. He has apparently never made a mayonnaise dressing.

"A pure mineral oil (sp. gr. 0.9) forms a milky emulsion with water after 48 hours' vigorous shaking. Whether one gets complete emulsification depends on the amount of oil taken. With 100 cc distilled water one can emulsify 2 cc oil completely by shaking at ordinary temperature by means of a hot-air motor. There are indications of a limit to the pseudo-solubility, though this depends to some extent on the kind and intensity of shaking. The emulsions thus obtained are stable for weeks. Under the microscope the particles show Brownian movements. The average diameter was about  $4 \times 10^{-5}$  cm. That is the same order of magnitude

<sup>1</sup> Such experiments are now under way in my laboratory.

<sup>2</sup> *Zeit. Kolloidchemie*, 4, 211 (1909).

that Burton<sup>1</sup> found for colloidal metals. The microscope showed that addition of different substances (salts) does not change the size of the oil drops appreciably; they remain of the same order of magnitude. In order to determine whether this really is a limiting value to the size of the particles, emulsions were prepared according to the following different methods:

(1) By boiling a drop of oil in water using a reverse condenser. After 30 hours' boiling, a partial emulsification had taken place. The emulsified portion was examined under the microscope and was found to contain particles of about the same size as those in the emulsions which were prepared by shaking.

(2) A small amount of oil was dissolved in alcohol and the solution poured into water. There was formed a milky emulsion at once, and the particles were of the same general size as those obtained by shaking. The emulsion thus obtained was uniform. This is the most convenient method of preparing emulsions when the presence of alcohol is not a disturbing factor.

(3) The milky product which one gets by distilling aniline with steam contains particles of the general magnitude of  $10^{-5}$  cm diameter. In this case coagulation takes place rapidly and therefore the emulsion is not uniform.

"It is worth noting that the size of the drops in these emulsions agrees with Donnan's approximate estimate<sup>2</sup> of the limiting size of a fine-grained heterogeneous system which is in equilibrium in respect to surface tension.

"The electrical charge carried by one particle of the emulsion was determined by Nernst's method, in a U-tube equipped with platinum electrodes. The experiments were carried out in a thermostat at 25°. The emulsion was placed in the tube and a layer of water allowed to flow in slowly from below. The potential difference between the two electrodes was 230 volts. The particles proved to be charged

<sup>1</sup> Phil. Mag., [4] 11, 425; 12, 472 (1906).

<sup>2</sup> Donnan: Zeit. phys. Chem., 46, 197 (1903).

negatively and moved [to the anode] with a velocity of  $4.3 \times 10^{-4}$  cm/sec. under a driving potential of 1 volt/cm. We can calculate the value of the potential difference between the water and the emulsified particles by means of Helmholtz's double-layer theory using Burton's formula, namely

$$v = \frac{4\pi\eta v}{kx}$$

where  $k$  is the dielectric constant of the medium,  $\eta$  its viscosity, and  $v$  the velocity of a particle under a driving potential of  $x$  units per centimeter. By substituting the actual values in this equation, we get

$$V = 0.05 \text{ volts.}$$

In order to determine the charge  $e$  on a particle of the emulsion, we use an equation based on Stokes' law,

$$e = \frac{6\pi\eta r v}{x}$$

where  $r$  is the radius of the particle,  $\eta$  the viscosity of the water,  $v$  the velocity of the particle under a driving potential of  $x$  per centimeter. For the oil-water emulsion we have

$$\begin{aligned} \eta &= 0.009 \text{ C. g. s. units at } 25^\circ, \\ \text{or } &= 2 \times 10^{-5} \text{ cm}, \\ v &= 4.3 \times 10^{-4} \text{ cm/sec. under a driving potential of 1 volt/cm,} \\ &= 12.9 \times 10^{-7} \text{ cm/sec. for one electrostatic unit per} \\ &\quad \text{centimeter.} \end{aligned}$$

From this we get

$$e = 4.4 \times 10^{-7} \text{ electrostatic units.}$$

"The value of a charge on a particle of emulsified oil is of the same order of magnitude as that on a particle of colloidal metal. This great similarity between colloidal metals and oil-water emulsions in regard to the critical size of the grain, to the electrical charge on the particle, and to the difference of potential between liquid and particles points very clearly to the conclusion that the conditions for stability are the same in the two cases."

In a later paper Lewis<sup>1</sup> takes up the question again. "It seems generally to be admitted that the two chief factors determining the equilibrium of colloids or of emulsions are the surface tension and the electrical charge. Starting from a consideration of the surface tension, F. G. Donnan<sup>2</sup> has shown that a critical size of grain is to be expected if one phase in a very fine state of subdivision is dispersed in another. Starting from a consideration of electrical phenomena, Hardy<sup>3</sup> has shown that, at the coagulation point, the difference of potential between the medium and the particles of the colloid has sunk to zero. This fact has been confirmed by Burton. It has not been shown; however, from consideration of the electrical phenomena, that there ought to be a limiting value for the size of the particles. Bredig<sup>4</sup> has considered the equilibrium as dependent both on the surface tension and on the electrical charge. He has tried to explain the precipitating action of electrolytes as due to the predominant solubility of certain ions. Freundlich<sup>5</sup> has advanced a somewhat similar view; but he considers that we are dealing with surface tension phenomena and that adsorption is the important thing. Freundlich has developed his very interesting views in several ways.

"Starting with the idea that the equilibrium of colloidal and emulsion particles depends on the simultaneous action of the surface tension and the electrical charge, it seems to me that the following passage from Sir Oliver Lodge's 'Modern Views of Electricity,' dealing with the condensation of moisture on an electrically charged nucleus, establishes a relation between surface tension and electrical tension which is applicable to the equilibrium of colloids and emulsions.

"The rapid evaporation of a small drop is due to the

---

<sup>1</sup> Zeit. Kolloidchemie, 5, 91 (1909).

<sup>2</sup> Zeit. phys. Chem., 46, 197 (1903).

<sup>3</sup> Ibid., 33, 385 (1900).

<sup>4</sup> Anorganische Fermente.

<sup>5</sup> Zeit. phys. Chem., 44, 129 (1903).

curvature of its surface and its surface tension; an electric charge tends virtually to diminish this, it tends to cause a slight surface pressure or distending force. A charged soap-bubble, for instance, is a trifle bigger than an uncharged one, the two effects of surface tension and electric tension are opposite. Not exactly opposite, for one is tangential and the other is radial; but whereas the tangential tension, on a convex surface like that of a liquid drop, has a resultant inwards—the electric ( $2\pi\sigma^2$ ) acts wholly outwards. The surface or cohesive tension of a liquid is an intense force, and even its radial component is moderately big, especially for small drops. The tension caused by a given electric charge is usually a small force, but it increases very rapidly as the body possessing the charge gets smaller. The effect of the cohesive tension varies inversely as the simple diameter of the drop. The effect of the electric tension varies inversely as the fourth power of the diameter of the drop. Hence as the drop shrinks the two opposing tendencies necessarily become equal when it reaches a certain minute size; and then the effect of its curvature is obliterated—it behaves as if flat. Such a drop can as easily exist as any liquid with a flat surface can; and any drop smaller than that would rapidly or even suddenly grow to this equilibrium size.”

“If we apply these considerations to a colloidal particle or to a drop in an emulsion, having a radius  $r$  and being suspended in a medium with a dielectric constant  $K$ , and if we assume that  $\rho$  is the density the electrical charge on the particle or drop and that  $\sigma$  is the surface tension between the drop and the dispersing medium, then the electrical pressure outwards is  $2\pi\rho^2/K$  and the radial component of the surface tension acting against the electrical pressure is  $2\sigma/r$ . If it is permissible to set these two expressions equal and if we substitute  $e/4\pi r^2$  for  $\rho$  we have

$$r^3 = \frac{e^2}{16\pi K\rho} \text{ or } r = \sqrt[3]{\frac{e^2}{16\pi K\rho}}$$

where  $e$  is the electrical charge on the particle or drop.



"A direct experimental proof of this formula is not possible for the only way in which we can determine the charge on a suspended particle<sup>1</sup> depends on the application of Stokes' formula for the migration of a particle in a given electrical field, and this formula contains both  $e$  and  $r$ , namely  $e = 6\pi\eta rv/X$  where  $e$  is the charge on the particle,  $\eta$  the viscosity of the medium,  $v$  the velocity of the particle under a driving potential of  $X$  units per centimeter. If we substitute this in the preceding equation, we get finally,

$$r = \frac{9\pi\eta^2 v^2}{4K\sigma X^2} \text{ or } \sigma = \frac{9\pi\eta^2 v^2}{4KrX^2}$$

All of these values can be determined experimentally with the exception of  $\sigma$ , for although we can determine this readily for a plane surface, we have at present no means of determining it for a surface of high curvature. Therefore we cannot test experimentally the equation as it stands. If we assume the validity of the formula, we can then make use of it to determine the value of the surface tension of a surface having a high curvature.

"We can substitute in this equation the data previously obtained for hydrocarbon oil emulsion in water at 25°. We have:  $r = 2 \times 10^{-5}$  cm;  $\eta = 0.0107$  c. g. s. units;  $v = 12.9 \times 10^{-2}$  cm/sec. under a driving potential of one electrostatic unit per centimeter ( $X = 1$ );  $K = 80$  electrostatic units. Solving, we find that  $\sigma = 0.009$  dynes per centimeter. Now the surface tension at the plane surface between oil and water was 45 dynes per centimeter as measured by the viscosity pipette. Consequently the electrocapillary forces arising from the increased curvature have decreased the surface tension to about one five-thousandth of its value for a plane surface. The value for  $\sigma$  thus obtained seems at first sight surprisingly small, but the following considerations seem to offer at least some general confirmation of the low value.

"We start with a large drop of oil in contact with water. If  $s$  is the surface of the drop and  $\sigma$  the surface tension, then

<sup>1</sup> Cf. Lewis: *Zeit. Kolloidchemie*, 4, 210 (1909).

$s\sigma$  is the total surface energy of the drop. This represents a stable system. We must not forget that even here the expression  $\sigma$  is a composite one, for it includes not only the simple capillary action but also a 'lowered' capillary action due to the existence of an electrical difference of potential at the surface between oil and water. We will now assume that we have prepared an emulsion of oil in water by vigorous shaking. This can actually be done if we do not take too much oil. The surface of the oil in contact with water is now many thousand times as large as before. If  $\sigma$  had maintained its original value the product  $s\sigma$  (the total surface energy of the system) would have increased enormously. Therefore, this system would not be stable and would tend to revert to the original condition with a decrease in the total surface. This tendency to a decrease in the surface is a familiar fact with plane, stretched films or surfaces. If we consider emulsions and colloidal solutions as stable systems, it follows that, when one phase is dispersed within another, the product  $s\sigma$  cannot be larger than when the two phases are present as single masses separated by a small surface. If an emulsion is a stable system, it follows that the surface tension can only be a small fraction of that which prevails at a plane surface. From these general considerations we thus reach the same conclusion which we found quantitatively starting with an equation based on the capillary and electrical pressure, and with Stokes' equation for the velocity of a body moving under a driving potential. On the assumption that the formula, thus deduced, is right, we can reverse the argument, in which case we reach the conclusion that an emulsion is a thermodynamically stable system.

"From the equation  $\sigma = 9\pi\eta^2v^2/4K\tau X^2$  we see also that for particles to have the same velocity in the same medium, the radii must be inversely proportional to the surface tensions. Now it has been established experimentally that colloid particles (metallic and non-metallic sols in water) move in an electrical field at approximately the same rate as the drops in an oil emulsion. The radii of the colloidal

particles are only about 0.1-0.02 those of the drops in the emulsions. Consequently, the surface tension at the surface between colloid and water must be 10-50 times as large as the corresponding surface tension in the emulsions. This was to be expected because the surface tension at a plane surface between mercury and water is about 300 dynes/cm, while the surface tension between oil and water is 45 dynes/cm under the same conditions."

This is very clever but one weak point seems to be the assumption (or conclusion) that a two-component emulsion is a thermodynamically stable system. The author admits that he cannot emulsify more than about 2 percent of oil and there is no evidence that the emulsion thus obtained will last more than a relatively short time. There is nothing in the discussion to show why there should be a 2 percent limit. The author might perhaps fall back on the statement that emulsions behave like colloidal solutions and that these are stable; but the same difficulty arises here. All the evidence that we have is to the effect that no two-component colloidal suspension is stable. Under these circumstances all we can say is that the author's conclusions may be more or less true but that they have not been proved.

The first of a new series of articles on the properties of oil emulsions has just appeared<sup>1</sup> from Donnan's laboratory. In the introduction Ellis says that the object of the paper was to obtain quantitative data on the electrical charge carried by the drops in an emulsion. These values, he says, might be of value in connection with results obtained by measuring contact potentials and surface tension in their bearing on electrocapillary and colloidal phenomena. "The effect of electrolytes on the electrocapillary phenomena and consequently on the contact potential has been studied carefully by Perrin<sup>2</sup> while the effect of dissolved substances on the surface tension has been treated by Bredig and by a large number of other observers. For further details we cannot

<sup>1</sup> Ellis: *Zeit. phys. Chem.*, 78, 321 (1911).

<sup>2</sup> *Jour. Chim. Phys.*, 2, 601 (1909).

do better than refer to Freundlich's "*Kapillarchemie*" where can be found excellent summaries of all branches of the subject.

"The contact potential proves not to be dependent solely on the nature of the substances in contact. Thus Cotton and Mouton<sup>1</sup> observed that colloidal particles of different sizes, suspended in the same medium, moved at quite different rates under the influence of an electrical field. Therefore results obtained with plane, or practically plane, surfaces cannot hold quantitatively for substances with a very high curvature, such as colloidal particles.

"The great difficulty in determining the contact potential of colloidal particles under different conditions is that of preventing coagulation. It is difficult, for instance, to obtain Hardy's iso-electric point because coagulation takes place before the sign of the charge changes. People have tried to overcome this difficulty by adding gelatine to the colloidal suspension and letting the whole set to a jelly; but there is the serious objection to this that one is adding a third substance and we do not know what effect its presence will have. Ordinary suspensions are of course very much less readily coagulated than colloidal solutions and could be employed if it were not for the fact that they settle, under the influence of gravity, too rapidly to permit of one's making an accurate determination of the rate of migration in an electrical field.

"Oil emulsions have great advantages over other emulsions or over colloidal solutions. The globules are relatively large ( $2 \times 10^{-4}$  cm in diameter) so that the Brownian movements are small and the drops therefore do not come in contact often enough to cause rapid coagulation. Since oil and water have very nearly the same density, the action of gravity can almost always be neglected and the emulsion can be studied under the microscope because the drops do not rise rapidly. The globules are spherical and so their size can be determined with accuracy and it is easy to calculate the re-

<sup>1</sup> Jour. Chim. Phys., 4, 365 (1906).

sistance to motion through the medium as well as other quantitative data. A further advantage is that the surface tension between the oil and the medium in which it is suspended can readily be determined for approximately plane surfaces though not for a surface with a very short radius of curvature. Finally, the size of a globule of oil suspended in another liquid probably is more closely a function of the electrical charge and the surface tension than is the case for any other suspension or colloidal solution. These advantages of the emulsions make it probable, as Donnan<sup>1</sup> has predicted, that the study of emulsions will lead us to a rational theory of colloids."

Ellis gives a critical discussion of the previous work of others on electrical migration and then says<sup>2</sup> that in preparing these emulsions every effort was made to get as nearly pure an oil-water emulsion as possible. "A special, acid-free cylinder oil (containing less than 0.03 percent acid considered as oleic acid) was shaken with distilled water, free from carbon dioxide, in steamed-out Jena glass flasks. After shaking for two or three days the emulsion was allowed to stand for about an hour so as to give the oil which had not been emulsified a chance to rise to the surface. The emulsion underneath was drawn off and filtered to remove any globules of partially emulsified oil. The emulsion thus prepared contains about one part of oil in ten thousand of water and has a specific conductance of about  $18 \times 10^{-4}$  cm. The concentration of the oil was so low and so nearly constant in every sample tested that no attempts were made to establish that the concentration of the emulsion was always exactly the same. The emulsion cannot be kept in glass vessels for any length of time because the considerable amount of glass which dissolves in the water affects the charge on the drops. Also, the globules adhere one to another forming agglomerated masses which do not break up readily when the flask is shaken and which therefore do not yield a uniform emulsion."

<sup>1</sup> Zeit. phys. Chem., 31, 42 (1899).

<sup>2</sup> Ibid., 78, 326 (1911).

Ellis<sup>1</sup> sums up his conclusions as follows:

(1) The contact potential at the oil-water surface and at the glass-water surface reaches a maximum in neutral or slightly alkaline solutions.

(2) The addition of hydrochloric acid decreases the contact potential very rapidly for low concentrations and only slowly for relatively high concentrations.

(3) The addition of caustic soda first increases the contact potential at the oil-water surface; when the concentration exceeds  $n/1000$ , the contact potential decreases, rapidly at first and more slowly afterwards.

(4) The contact potential at the oil-water surface is of about the same order of magnitude for different oils, regardless whether they are pure or contain large amounts of impurities.

(5) The contact potential at the oil-water surface is of the same order of magnitude as that at the glass-water surface and at the surface of suspended particles of colloidal metals, lycopodium, quartz, and other substances.

(6) The contact potential in neutral solution appears to depend almost completely on the dielectric constants of the suspended particles and of the medium in which they are suspended.

(7) The decrease of the contact potential on addition of hydrochloric acid or caustic soda depends probably on some sort of electrical adsorption.

(8) If one considers an atom as a condenser with a uniformly distributed charge, it appears from the results on the migration of a globule of oil that Stokes' law holds for particles whose size approximates molecular dimensions.

This otherwise very excellent paper does not add much to our knowledge of the theory of actual emulsions. Working as the author does with what is practically a two-component system he gets an emulsion which is not very stable and which contains only about one part of oil in ten thousand of water,

---

<sup>1</sup> *Zeit. phys. Chem.*, 78, 352 (1911).

which may be an ideal emulsion; but that is certainly all. The author has done very well along his own line of attack; but his problem is not ours. He does not consider the possibility of two sets of emulsions; he does not take into account any question of limiting concentrations; and he does not show why the emulsion, obtained by shaking oil and water together, is an emulsion of oil in water and not of water in oil.

In a study on the cleansing power of soap, Hillyer<sup>1</sup> takes up the general question of emulsifying action apparently without any knowledge of Donnan's earlier work.

"It is often suggested, either as a distinct theory or as a more or less important adjunct to the saponification theory, that the alkali set free by hydrolysis acts on the fat by emulsifying it, and carrying it away in suspension with other impurities. This suggestion has come apparently because those who have emulsified oils with alkali have used oils not free from fatty acids. It is also suggested that the emulsification is due to the undecomposed soap, but experiments are not recorded as far as can be ascertained to sustain this view or to determine whether the action is due to the soap or to the alkali.

"When good cottonseed-oil, 'salad oil,' is shaken with weak alkali it is largely emulsified, but by washing the emulsion with water and dilute alkali alternately for many times, the soap formed by the action of the alkali on the free acid of the oil is removed, the oil separates from the emulsion, and a product is obtained which is not emulsified by decinormal sodium hydroxide. Neither is kerosene emulsified by decinormal alkali. Both kerosene and purified cottonseed-oil easily make permanent emulsions with a decinormal solution of sodium oleate. From this experiment, it seems certain that the emulsifying power of the soap solution, is due to the soap itself rather than to the hydrolytic alkali.

"The explanation of the action of soap as due to its emulsifying power is a plausible one, but no clear account

<sup>1</sup> Jour. Am. Chem. Soc., 25, 513 (1903).

has been given, or made current, at least, in chemical literature, of the physical properties which a liquid must have to be a good emulsifying agent. The great similarity between foams and emulsions in method of making and in properties, suggests the question whether any explanation given for the formation and permanence of foams will not also apply to the formation and permanence of emulsions. Plateau and Quincke have made extensive studies of substances which foam and of those which are emulsifying agents.

“There will be here no attempt to detail their results or to follow exactly their reasoning but the general trend of their work will be indicated. They have shown that soap solution has a surface-tension which is lower than that of any other aqueous solution. Its surface-tension is, in fact, only about 40 percent that of pure water. This may be shown in several ways. When two capillary tubes of the same diameter are placed respectively in water and in soap solution, the water will be seen to rise about 2.6 times as high as the soap solution. If a given volume of water is allowed to drop from a broad-ended pipette or stalagmometer and then a soap solution is allowed to drop from the same pipette, it will be found that the soap solution will make 2.6 times as many drops as the water. The cohesion of the soap solution is so small that the surface-tension will sustain drops of a volume only about 40 percent of the volume of those formed by water. Plateau<sup>1</sup> lays the power of foaming bubbles, films, and foam to two factors: first, the liquid must possess notable viscosity, that the film may not readily yield to the forces which tend to thin it to the point of rupture; secondly, it must have a low surface-tension since the surface-tension is the most active force in thinning the film. Soap solutions are ordinarily quite viscous, and this viscosity is increased in Plateau's bubble mixture by adding glycerine, which aids in making bubbles and films permanent. Soap solutions have a low surface-tension and, on account of these two factors, soap

<sup>1</sup> Pogg. Ann., 141, 44 (1870).



solutions easily yield and enduringly maintain films and foam.

“Quincke<sup>1</sup> has similar fundamental views, but ascribes the permanence of a foam to the mixed character of the liquid which foams, and claims that no pure liquid will foam. According to Quincke the permanence of the foam is due to the action of surface-tension which spreads out over the surface of the film some secondary ingredient of the solution, and this tends to close up any potential ruptures in the film. Plateau calls attention to the important part played by viscosity in these phenomena and speaks of the existence of a viscosity which pertains to the liquid itself, its internal viscosity, caused by the friction of the molecules of the liquid on each other and also of a second kind of viscosity, which he calls superficial viscosity, which sometimes makes the motion of a foreign body upon the surface of a liquid more or, on the other hand, less ready than within the liquid. Stables and Wilson<sup>2</sup> have confirmed Plateau's work, and find that the motion of a body in the surface of a solution of saponin is resisted 600 times as much as it is within the same solution. By this great superficial viscosity they account for the great foaming power of saponin solution, although it has a comparatively high surface-tension.

“To make these ideas clear a simple case may be used as an illustration. Suppose two bubbles of air to be lying side by side within a mass of water. The molecules of water at the point of nearest approach of the bubbles are acted on by the stress of the surface-tension of both bubbles, and this causes a thinning of the film between them. The surface-tension is great and the water is mobile so that the thinning will be rapid and soon the bubbles will coalesce by the breaking-down of the membrane. If, instead of water, soap solution is present, the stress which causes thinning will be less on account of the much smaller surface-tension and the resistance to thinning, due to the viscosity of the soap solution,

<sup>1</sup> *Wied. Ann.*, 35, 592 (1888).

<sup>2</sup> *Phil. Mag.*, [5] 15, 406 (1883).

will be somewhat greater and as a result the bubbles will remain separate for a much longer time. In the same way a mass of bubbles will remain permanent longer in soap solution than in water.

"A table is here presented showing some observations made by the writer in confirmation of the work of Quincke and Plateau. While they claim no considerable accuracy, they show in general the tendency which solutions of high viscosity and low surface-tension have to make foams. The figures in the second column show the number of minutes

	Time	Drops	Foam
Water	3	47	—
Stale beer	—	79	+
Sweet skimmed milk	4	75	+
Saponin, 0.5 percent	3	55	+
Albumin, 3 percent	3	58	+
N/10 NaOH + equal volume alcohol	8	110	—
Glycerine, 50 percent	14	60	—
Gum acacia, 6 percent	8	49	—
N/10 rosin soap	3	104	+
N/10 sodium oleate	4	104	+
N/640 sodium oleate	3	108	little

required for the volume of liquid contained in the stalagmometer to flow out and consequently give a rough measure of the internal viscosity of the solutions. The third column gives the number of drops formed from the given volume, when the drops were formed in air. In the fourth column the plus signs indicate that the solution makes a permanent foam and the minus signs that it does not. Water gives the smallest number of drops and has the highest surface-tension. The solution of sodium resinate and the solutions of sodium oleate give the greatest number of drops, and have the least surface-tension. That viscosity alone will not account for permanent foam formation is shown by the cases of glycerine and gum acacia where there is high viscosity but also high surface-tension and no foam. Beer and milk have a higher viscosity and lower surface tension than water and yield foams. The

decided apparent exceptions are albumen and saponin, and alcoholic alkali. Saponin and albumen have, however, in a very marked degree, the property of superficial viscosity, and this accounts for the persistent foam in spite of their low internal viscosity and comparatively high surface-tension. On the other hand, while the solution of alkali in dilute alcohol has a high internal viscosity and a markedly low surface-tension, the temporary character of its foam may be accounted for by the fact discovered by Plateau that alcohol has a negative superficial viscosity. That the alcohol has the effect of diminishing foam power may be seen by adding a small quantity to a soap solution, which then loses its foaming power to a marked degree.

#### **Emulsions**

"Can emulsification be explained by the viscosity of the emulsifying agent? In the case of very thick liquids like the gum solutions used by the pharmacists, it is probable that the extreme viscosity is a very large factor in giving permanence to the separation of the oil droplets which have been formed mechanically. That even very large internal viscosity will not make an emulsion permanent is shown by the fact that 50 percent glycerin and 6 percent gum solutions which have viscosity of a high degree will not emulsify kerosene or even a viscous oil like cotton oil. Saponin or albumen solution with high superficial viscosity will give permanent emulsions. Dilute soap solutions which have not great viscosity have very great emulsifying power, and the same is true to a less degree of some other solutions. From these facts it must be decided that internal viscosity of the liquid will not account for its emulsifying power.

"It has been seen that foaming can be explained largely by the small surface-tension of soap solution towards air. Surface-tension phenomena show themselves between two liquids as well as between a liquid and air. The question arises whether there is any peculiarity in the degree of surface-tension between soap solution and oils, not shown by other solutions.

“Quincke<sup>1</sup> observes that when a solution of sodium carbonate is brought in contact with an ordinary oil, phenomena are exhibited which he ascribes to the change of surface-tension between the oil and aqueous solution on account of the formation of soap. Among the phenomena accounted for in this way is that of emulsification. Quincke does not use pure oils or single soaps nor, except casually, does he refer to the low surface-tension between oils and soap solutions.

“To more definitely answer the question as to the relation of surface-tension and emulsifying power, experiments were made by the writer to measure roughly, by the dropping method, the relative surface-tension of water and of soap solution toward typical oils. According to Quincke a solution of Venice soap containing 1 part in 40 of water has toward air a surface-tension of 2.563, a solution of 1 part in 400 has a surface-tension of 2.681. In other words, according to these careful determinations, concentration has very little influence on the surface-tension of soap solution in contact with air. With this constant and comparatively small reduction of surface-tension which soap solution shows as contrasted with water, it is interesting to compare the enormous and variable reduction of surface-tension shown when soap solutions of increasing concentration are allowed to flow through oils.

“When cottonseed-oil is allowed to flow slowly up through water, it makes much larger drops than are made when it flows up through soap solution. The same is true when kerosene is used. The surface-tension between the oils and soap is much less than between the oils and water. A much more convenient method of studying the surface-tension is to let the water or solution flow down through the oils. In this work the greater number of observations were made with a stalagmometer intended as an alcoholimeter and holding 5.35 cc.

“When water flows from a stalagmometer with its tip

<sup>1</sup> Wied. Ann., 35, 580 (1888).

immersed in oil, large drops are formed. When a weak soap solution replaces the water, the drops are smaller. When stronger and stronger soap solutions are used, the drops grow smaller and more rapid, if the rate of flow of the liquid is not checked, until with a strong solution the rate of flow is too rapid to give time for the formation of separate drops and a very thin cylindrical stream flows from the stalagmometer. The surface-tension has become so small that it does not support the liquid long enough to form drops. In this case, gravity is strong enough to almost completely overcome the action of surface-tension and draws the solution out into a fine thread. It seems reasonable to suppose that any other outside force could easily break up this strong soap solution within the oil into small droplets, or spread it into films on account of the small surface-tension. According to the theory of surface-tension between two liquids, surface-tension will be great between them, when each liquid has strong internal attractive forces, that is, strong cohesion; and it will be small when they have slight attraction for one another, that is, slight adhesion or mutual affinity. Small surface-tension will be caused by a weak cohesion of at least one of the liquids and a strong adhesion or affinity of the liquids to one another. Water forms large drops in oil on account of its great cohesion and its small adhesion to the oil. Soap solution makes small drops or runs down in a stream; because, first it has a low cohesion and secondly, because it has a strong adhesion to the oil or a strong affinity or attraction for it.

"It would seem that this low surface-tension of soap solutions must be a prime factor in their emulsifying power. Viscosity can have very little to do with it, for solutions containing about 1 percent of sodium oleate are excellent emulsifying agents but have a viscosity so low that careful measurements would be necessary to show that they are more viscous than water. Using the same reasoning as in the case of bubbles and foam, we may say that when oil drops approach each other in water, they tend to coalesce and

finally do so because the great surface-tension of the drops easily withdraws the mobile water from between them till they touch and coalesce. But when the drops are in soap solution, the surface-tension is so very much less that it is not able to withdraw the solution rapidly from between the drops, and they are kept separate. If the soap solution is notably viscous, the slight surface-tension will have still greater difficulty in thinning the films to the point of rupture. A mass of droplets separated by films of a low surface-tension and notable viscosity will be a permanent emulsion.

“Quantitative relations between the surface-tensions of certain solutions are given in the following table. The measurements are only approximate, but, for the purpose, adequate. The first column (K) indicates the number of drops formed when 5.35 cc of the solutions named flow into a certain kerosene. The second column (Emul. K) indicates by a plus sign, that the solution, when shaken with the kerosene, will yield an emulsion. The third and fourth columns, C. S. oil and Emul. oil, give similar data for cottonseed-oil carefully purified from free acid by washing with dilute alkali.

	K	Emul. K	C. S. oil	Emul. O
Water	17	—	9	—
Stale beer	39	little	—	—
Sweet skimmed milk	—	—	52	+
Saponin	—	—	13	+
Acacia	—	—	14	+
Alcohol and sodium hydroxide	51	little	..	..
N/640 sodium oleate	26	little	..	..
N/10 sodium oleate	296	+	167	+
N/10 rosin soap	310	+	180	+
N/10 sodium chloride	17	—	..	..
N/10 sodium hydroxide	17	—	10	—
Sodium silicate	..	..	15	—

From these data, it will be seen that the solutions which emulsify have a larger number of drops, that is, “a smaller surface-tension than those that do not.”

“Saponin solution containing 1 part of the glucoside to 200 of water is an excellent emulsifying agent, and yet its surface-tension toward oil is not enormously reduced from that of water, but its emulsifying power is easily understood when one observes the form of the drops produced when it flows through cottonseed-oil. Quincke has observed similar drops when albumen solution flows through oil. We may make a soap solution, one containing 1 part of sodium oleate in about 500 parts of water, when it flows through oil, will give the same number of drops as the saponin solution used. The drops of soap solution form normally, and, as they fall, assume quickly a spheroidal shape, while the hanging drop quickly takes the form of a catenoid. A drop of saponin solution as it is detached takes the form of a Rupert drop and, falling to the bottom, takes the form of a pear, with the stem plainly visible. This stem, the remains of the filament drawn out as the drop was detached, may remain visible for many minutes. The hanging drop, if the flow of solution is stopped just after the fall of the drop, has the shape of an inverted cone, with incurved sides and a slender peak. This shape is retained a long time. When new liquid flows in, the hanging drop changes its shape only as its surface is swelled out by the inflowing liquid. That the liquid is not in itself viscous may be known by observing the ready rotations and other movements of chance particles within the drop as the liquid flows down.

“Here we plainly have a new instance of superficial viscosity, a viscosity which makes motion difficult in the surface between the two liquids. This it would seem, being of so considerable a degree, may account for the resistance offered to the withdrawal of the films of saponin from between the oil droplets of a saponin oil emulsion, and consequently for the permanence of the emulsion.

“The conclusion arrived at is that emulsification is due largely to the small surface-tension between oil and the emulsifying agent which allows the emulsifying agent to be spread out into thin films, separating the oil droplets. The

surface-tension is not strong enough to withdraw the film from between the droplets except slowly and, if the emulsifying agent has great internal viscosity, or if great superficial viscosity is shown between the liquids, the thinning of the film becomes so slow that the emulsion is permanent."

Hillyer's views correspond very closely with those of Donnan, except that Hillyer lays more stress on the importance of viscosity or of surface viscosity, Höber<sup>1</sup> goes one step further and claims that the emulsifying agent must itself be a colloid. He considers a stable emulsion as analogous to a colloidal suspension made more stable by means of a protecting colloid.

"Some other processes in the cell probably also come under the heading of adsorption of colloids. We saw that drops of chloroform or carbon bisulphide in solution of albumen become covered with a membrane of albumen. Such membranes, resulting from the contact of two solutions have been known in biology for a long time under the name of haptogen membranes. It is to them that we owe, in large part, the permanency of the emulsions which occur in many physiological solutions. Thus the continued, fine distribution of fat in milk is due to the existence of a film of caseine around the globule of fat. The emulsifying action of small amounts of alkali on a mixture of oil and water is due to the formation of membranes of soap at the surface between oil and water. In order to obtain a fine-grained emulsion it is not sufficient to add a substance which concentrates in the surfaces between two liquids. By addition of chloroform or acetone to oil and water, we get no emulsion. It is necessary that the added substance should be a hydrophile colloid which is adsorbed in its peculiar way with formation of a solid film.<sup>2</sup> Perhaps the new formation of a semipermeable membrane around a drop of protoplasm is to be considered as a formation of a haptogen membrane; certain substances dissolved

<sup>1</sup> *Physikalische Chemie der Zelle und der Gewebe*, 3rd Ed., 293 (1911).

<sup>2</sup> Cf. Pickering: *Zeit. Kolloidchemie*, 7, 11 (1910). Donnan and Potts: *Ibid.*, 7, 208 (1910).



in the protoplasm may be adsorbed by the surface of the fresh wound, the surface between protoplasm and water." This is much more definite than Freundlich's rather non-committal statement<sup>1</sup> that "the reason why colloidal substances like soaps, albumen, starch and glue are especially effective as emulsifying agents is that, since these substances diffuse slowly, adsorption and the equalization of differences of concentrations do not take place rapidly and consequently the differences in the surface-tension remain long enough to allow the mechanical action to take place."

Höber was, of course, considering the normal case of emulsion with water as the dispersing phase when he stated that a hydrophile colloid must be used as an emulsifying agent. Had he been considering the general problem he would probably have made the statement that an oleophile colloid should be used as an emulsifying agent if one wishes to prepare an emulsion of water in oil.

Except for this statement by Höber and what it implies, people are pretty well at sea as to what determines whether we shall get water or oil forming drops when we shake the two together. The simplest view to take would be that the liquid with the lower surface-tension would tend to spread out over the liquid with the higher surface-tension. This cannot be anywhere near the whole truth, however, because water has a very high surface-tension and we should therefore expect that the common type of emulsion would be the one in which water is present in drops. This is not the case experimentally and there is evidently something wrong or incomplete in the otherwise plausible hypothesis. The following quotation from Freundlich<sup>2</sup> will show the extent and applicability of our knowledge of surface-tension phenomena between two liquid phases.

"The question of the relation between the surface-tension at the surface between the liquids and the surface-tension of the pure liquids at the surfaces between liquid and vapor,

<sup>1</sup> Freundlich: *Kapillarchemie*, 459 (1909).

<sup>2</sup> *Kapillarchemie*, 136 (1909).

is one that was raised early. Attention was drawn to the problem because of the peculiar movements taking place when two liquids having very different surface-tensions, were brought in contact. These are familiar from the behavior of water and alcohol; and this is not the place to discuss them in detail. It suffices to say that a drop of a liquid B usually does not remain at rest when placed on the surface of a second liquid A; it very often spreads out in a thin film over the surface of liquid A. We may ask under what conditions such a spreading out takes place. If we have a drop of B on A, as shown in Fig. 2, it is clear that the point P is

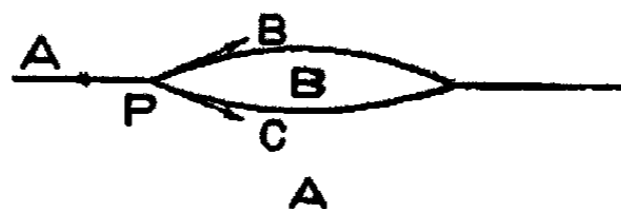

Fig. 2

under the influence of three forces. In the direction PA we get the action of the surface-tension  $\sigma_A$  of the surface between liquid A and vapor; in the direction PB the surface-tension  $\sigma_B$  of the surface between liquid B and the vapor; while in the direction PC we have the surface-tension  $\sigma_{A-B}$  of the surface separating liquids A and B. If we assume that the two liquids are miscible in all proportions, which means that the static value of  $\sigma_{A-B}$  is zero and that the dynamic value is small, liquid B will spread out over liquid A if  $\sigma_A > \sigma_B$ . Experiment confirms the conclusion that, with two completely miscible liquids, the one with the lower surface-tension will spread out over the one with the higher surface-tension. In fact we may make use of the phenomenon of spreading out in order to determine which of two consolute liquids has the higher surface-tension: very slight differences in the surface-tension in this way. Thus a warmer liquid spreads out over a colder layer of the same liquid.

“If  $\sigma_{A-B}$  has a finite value, the liquids are not completely miscible and there are several possibilities. We will assume that  $\sigma_A$  is always larger than  $\sigma_B$  but we will assume

in one case that  $\sigma_{A-B}$  is large and in another case that it is small. For liquid B to spread out over liquid A we must have

$$\sigma_A > \sigma_B + \sigma_{A-B}$$

if  $\sigma_{A-B}$  is fairly large,  $\sigma_A$  may not be much larger than  $\sigma_B + \sigma_{A-B}$ . We must also remember that  $\sigma_A$  and  $\sigma_B$  do not remain unchanged. We have B dissolving to some extent in A and A in B. The previous discussion<sup>1</sup> showed that the changed static tension  $\sigma'_A$  of A will usually be smaller than  $\sigma_A$  while  $\sigma'_B$  is likely to be larger than  $\sigma_B$ . Even with very insoluble substances, such as kerosene and water, we must assume that some of the vapor of B (kerosene) will condense on the surface of A (water) and thus lower the surface-tension. It may easily happen that the condition will be satisfied

$$\sigma'_A = \sigma'_B + \sigma_{A-B}$$

In this case not even the first drop of B will spread out on A. The vapor of B, or the first traces of the liquid, will suffice to reduce  $\sigma_A$  to  $\sigma'_A$  and the remainder of the liquid will be kept as a lenticular drop on the surface. This case is especially likely to occur when  $\sigma_{A-B}$  is fairly large, for instance with kerosene and water, water and benzene, water and chloroform, etc.

"If  $\sigma_{A-B}$  is very small, as is the case with liquids which are fairly soluble one in the other, we find that the first drop of B spreads out over A because

$$\sigma_A > \sigma_B + \sigma_{A-B}$$

The first drop does not suffice to saturate A and B and to lower  $\sigma_A$  to  $\sigma'_A$  such that a first drop of B shall not spread out. We still have

$$\sigma'_A > \sigma_B + \sigma_{A-B}$$

and this may continue to hold while many more drops are added. It ceases to be true when A becomes covered with a film of B. We get cases of this type with pairs of liquids giving small values for  $\sigma_{A-B}$ , for instance water and ether, water and turpentine, water and linseed oil, etc.

<sup>1</sup> Freundlich: Kapillarchemie, 58 (1909).

"Anything that decreases  $\sigma_{A-B}$  tends to make the drop spread out. When dissolved substances decrease  $\sigma_{A-B}$  very much they cause the drop to spread out. Pure kerosene,  $\sigma_{A-B} = 48.3$ , stays as a drop on water; but kerosene containing mastic spreads out readily over water,<sup>1</sup> the value of  $\sigma_{A-B}$  being 16.3. This is especially true for substances which are soluble in B and which reduce the surface tensions  $\sigma_B$  and  $\sigma_{A-B}$ . With substances which dissolve in A and which lower the surface tension  $\sigma_A$ , the tendency for B to form lenticular drops on A is increased. If we have an oil which contains fatty acids and place a drop of it on the water, the fatty acid will first spread out because its  $\sigma_B$  and, still more, its  $\sigma_{A-B}$  are smaller than the corresponding  $\sigma_B$  and the  $\sigma_{A-B}$  of the oil. The film of fatty acid on the surface of the water lowers the surface-tension of the water so much that the oil does not spread out at all because  $\sigma'_A$  is no longer larger than  $\sigma_B + \sigma_{A-B}$ . It is also possible that hydrolysis of the oil may take place more in the surface because oleic acid lowers the surface-tension very much. If so, we should get the same phenomenon even with an oil which originally contained no free oleic acid.

"The same is true if the surface of A originally contains an impurity which lowers the surface-tension. In that case  $\sigma_A$  may be so small from the start that it does not overbalance  $\sigma_B + \sigma_{A+B}$ . Under some circumstances it is therefore a sign of the purity of a surface, for instance of mercury, that a drop of another liquid spreads out on it.

"We have now to consider the question whether there really is an equilibrium

$$\sigma'_A = \sigma'_B + \sigma_{A-B}$$

when we have a lenticular drop resting on a liquid. Is the component for  $\sigma'_B + \sigma_{A-B}$  equal but opposed to  $\sigma'_A$  or do the two liquids meet at a finite contact angle in which case the cosine of the angle should appear in the formula? As a

<sup>1</sup> Pockels: Wied. Ann., 67, 668 (1899).

matter of fact the contact angle seems to be usually practically zero, for the relation

$$\sigma_{A-B} = \sigma'_A - \sigma'_B$$

seems to hold within the limits of error, provided one takes the precaution of using the surface-tensions at equilibrium,  $\sigma'_A$  and  $\sigma'_B$ , and not the surface-tensions,  $\sigma_A$  and  $\sigma_B$ , of the pure liquids. Antonow<sup>1</sup> is the only one of the experimenters who has really been careful in regard to this, and it is not an easy matter to determine the true values. When the value for water, saturated with chloroform, was determined without any special precautions, Antonow found for  $\sigma'_A$  a value of 61-64 dynes/cm. When he pressed the liquid into the pipette in such a way that the air current passed through a chloroform-water mixture and was therefore saturated with chloroform, he obtained a value of 54.0 dynes/cm. In the following table, which gives Antonow's data for testing the formula,  $\sigma'_A$  refers always to water and  $\sigma'_B$  to the other liquid.

Liquids	$\sigma'_A$	$\sigma'_B$	$\sigma'_A - \sigma'_B$	$\sigma_{A-B}$
Water, benzene	60.0	28.2	31.8	32.6
Water, isobutyl alcohol	23.9	22.5	1.4	1.76
Water, isoamyl alcohol	25.7	21.1	4.6	4.4
Water, ethyl ether	26.7	17.3	9.4	9.12
Water, chloroform	54.0	26.6	27.4	27.7

"The surface-tension at the interface of the two liquids can be calculated from the surface tensions at equilibrium but not from the surface tensions of the pure liquids."

Nernst is credited with saying that it is easier to work out new generalizations for oneself than to find them in Gibbs' Thermodynamic Studies. It will probably prove easier to apply a theory of emulsification to the facts given by Freundlich than to deduce a theory of emulsification from this passage in Freundlich's book, good though that book is.

The general results of this first paper are:

(1) With two non-miscible or partially miscible liquids,

<sup>1</sup> Jour. Chim. Phys., 5, 372 (1907).

two sets of emulsions are theoretically possible over practically the whole range of concentrations. In one series of emulsions "oil" will be present as drops while "water" will be present as drops in the other series.

(2) No one has prepared the two sets of emulsions for any pair of liquids.

(3) By shaking a fairly pure oil with water Lewis obtained an emulsion containing 2 percent of oil. With water and a hydrocarbon oil containing not more than 0.03 percent oleic acid Ellis only obtained an emulsion containing one part of oil to ten thousand of water.

(4) It seems probable that no stable emulsion can be prepared with a two-component system consisting of two mobile liquids.

(5) To obtain a more stable and a more concentrated emulsion a third substance must be added as an emulsifying agent.

(6) When water is the dispersing phase, the emulsifying agent should lower the surface tension of water (Quincke, Donnan) and should be viscous (Quincke, Hillyer).

(7) When water is the dispersing phase, the emulsifying agent should be a hydrophile colloid (Höber). Höber does not draw the conclusion that the emulsifying agent should be an oleophile colloid in case the emulsion is to contain water in drops.

(8) There is as yet no published theory connecting emulsification with the relative surface-tensions of the two pure liquids which are to be emulsified.

(9) Foam is an emulsion in which the dispersed phase is a gas and not a liquid. A gel is a limiting case of an emulsion; the dispersing liquid being lacking.

(10) The electrical charge on the drops of an emulsion is analogous in nature and value to that on suspended particles.

## A NEW METHOD OF DETERMINING THE RANGE OF MOLECULAR ACTION AND THE THICKNESS OF LIQUID FILMS

BY M. M. GARVER

A reliable method of determining the average distance at which molecules act on each other has long been sought. Several methods have been employed and have given results that, while not very consistent among themselves, have yet given values of the same order of magnitude. Since the introduction of the electron theory and the view of the corpuscular constitution of the atom, the actual dimensions of the molecular nucleus as a whole have become a less definite physical conception; but the molecule as a unit still retains its definiteness of character, notwithstanding the changed view as to the constitution of the individual atoms which form the molecule. Hence the sphere of activity, and the degree of proximity, of molecules in the different phases are still regarded as definite physical quantities of a nature to permit of numerical estimation in terms of experimentally measured magnitudes.

In the present paper it is not proposed to review the various attempts that have been made and the methods that have been used; but merely to develop the present theory and illustrate the method of computation; to give a brief discussion of the new constant in connection with the general gas equation and make a few general applications of the results. In conclusion, a tabulated list of the calculated results for a few well-known substances will be appended.

In 1870 Sir William Thomson<sup>1</sup> showed that there is a close dynamical relation between the curvature of a liquid surface and the density of the saturated vapor in contact with it. I have not seen the original paper, hence, must quote at second-hand. Poynting and Thomson<sup>2</sup> develop Thomson's

<sup>1</sup> Proc. Roy. Soc. Edin., 7, 63 (1870).

<sup>2</sup> "Text-book on Physics," 3, 314.

conceptions and show how the vapor-pressures of vapors in equilibrium with plane and curved liquid surfaces may be expressed as a function of the surface-tension of the liquid, the vapor, and liquid, densities and pressures. Now all these quantities are definite physical constants whose numerical value may be found by more or less accurate measurements. The formula connecting them contains only one approximation of importance theoretically—the value of the density of the liquid is used instead of the difference in density of the liquid and vapor; but except at high pressures and near the critical state this approximation leads to no appreciable numerical error. It cannot affect the significant figures for ordinary temperatures and pressures of the great majority of liquids and vapors. It will be unnecessary to repeat here the proof of the formula which they give. It may be emphasized, however, that the formula merely represents the functional relation of the various quantities deduced directly from experimental observations in accordance with the principles of energy. It is, therefore, undoubtedly entitled to as much credence as other similarly deduced functions; but a mere statement of the functional relation of physical quantities is not sufficient to satisfy the mind. Some thinkable causal relation is demanded. Is it quite satisfactory to know, merely, that, in order to maintain equilibrium, the vapor-density close to a convex liquid surface must be denser than is necessary when the surface is plane? This mental hiatus is sometimes bridged by expressing the relations in terms of pressure. But is not pressure just as much a *non-sequitur* as curvature? How can a pressure exerted on a liquid conceived of as made up of discrete particles held together by attractive forces, in any thinkable way, be connected causally with a greater vapor density, especially when the pressure due to the surface-tension is infinitesimal as compared to the interior pressure in liquids? If the pressure, supposed to be due to internal attractions, should be sufficient to increase the density, how could this increase in density, due to the molecular attractions, aid in freeing the molecules



from the very attractions which, when sufficient, prevent the formation of any vapor whatever?

These considerations forcibly presented themselves to my mind while studying the supersaturation of the atmosphere with moisture. A large increase in pressure of saturated air does not cause a deposit of moisture unless the temperature is lowered at the same time. It is but recently that hygrometric tables have been prepared that take into account the effect of barometric pressure as well as temperature, in determining the moisture content of the air. It is sometimes stated as one of Dalton's laws that the quantity of moisture in saturated air depends only on the temperature. This is a mistaken notion; for it can be shown that air under pressure in contact with liquid water will take up more moisture with increasing pressure.<sup>1</sup> But, as previously intimated, increased pressure except as measured by the actual increase in liquid density, does not account for the undoubted fact that there *is* an increase in vapor-density accompanying an increase in pressure. It is possible, however, to obtain by analysis a kinetic interpretation of the conditions necessary to produce molecular equilibrium expressed in terms of the space relations of the molecules, including change in liquid density.

For, consider a spherical globule, or drop, of water in equilibrium with its saturated vapor. Kinetic equilibrium must consist merely of a balanced interchange between the two phases. Hence, during the equilibrium of the vapor and liquid phases of a substance, suppose that  $n_1$  molecules of vapor per unit area of the intervening area of liquid surface return to the liquid as many molecules as the  $n_2$  molecules of liquid per unit area emit when the intervening *surface is plane*. Let us suppose that the interchanges taking place extend to an average distance, or depth,  $\epsilon$  on both sides of the interface, or surface, of the liquid of area  $a$ . The ratio  $n_1/n_2$  will be the same as the ratio of the vapor-density,  $\sigma$  to the

<sup>1</sup> Poynting: *Phil. Mag.*, [5] 12, 39 (1881). Lewis: *Proc. Am. Acad.*, 36, 143 (1900).

liquid-density,  $\rho$ , or  $\sigma/\rho = n_1/n_2$ . Now let us suppose that when the liquid is in the form of a spherical drop in equilibrium with the surrounding vapor the area of the drop is  $a$ . The vapor at an average distance,  $\epsilon$ , from the surface of the drop will lie on a sphere of area,  $a + \Delta a$  and the liquid at an average distance,  $\epsilon$ , on the other side of the surface, inside the drop, will occupy (omitting second order differences) a sphere of area  $a - \Delta a$ . Now, the  $n_1$  molecules of vapor per unit area multiplied by the area, or  $n_1 (a + \Delta a)$  must maintain equilibrium with the  $n_2 (a - \Delta a)$  molecules of liquid acting through the same area,  $a$ . The ratio, when the intervening area is plane is  $n_1/n_2$ . When the intervening surface of area  $a$ , is spherical, the ratio, as just shown, must be  $n_1(a + \Delta a)/n_2(a - \Delta a) = \sigma'/\rho'$  (say). If the liquid does not change density,  $\rho' = \rho$  and the ratio  $\sigma'/\sigma$  will be  $(a + \Delta a)/(a - \Delta a)$  which represents the ratio of vapor-density in equilibrium with a spherical drop of area  $a$  to the vapor-density in equilibrium with an equal plane area  $a$ . If we assume that the vapor-pressure,  $\omega'$  and  $\omega$ , are proportional to the densities,  $\sigma'$  and  $\sigma$ , we shall have

$$\frac{\sigma'}{\sigma} = \frac{\omega'}{\omega} = \left(\frac{r + \Delta r}{r - \Delta r}\right)^2 = \left(\frac{1 + \frac{\Delta r}{r}}{1 - \frac{\Delta r}{r}}\right)^2 \dots\dots\dots (A)$$

where  $r$  is the radius of the drop and  $\Delta r = \epsilon$ , is the average distance, or range of molecular action in which the change of phase from liquid to vapor and *vice versa*, takes place.

The formula (A) expresses purely geometrical relations and should hold for all values of  $r$  where there is no appreciable change in the density of the liquid. A change in the liquid density would change the ratio  $n_2/(a - \Delta a)$  by also changing the value of  $n_2$ . If there should be an appreciably greater density in the superficial film than in the rest of the drop, then the average density of small drops will be greater than the average density of large drops where the surface film is a smaller proportion of the whole drop. Conversely, if the function (A) satisfies the dynamic conditions, then the varia-

tions in vapor-density accompanying variations, in the size of drops may be attributed exclusively to the influence of curvature; but if it fails for small drops, the failure may be attributed to the varying influence of the density of the superficial film on the average density of the *active portion* of the drops. By a parity of reasoning we may conclude that the degree of departure of the geometric function from the requirements of the dynamic function is a measure of the degree of increase in density in the superficial film as compared with *the average density of the active portion of the liquid*.

We shall find that the foregoing considerations have an important bearing on the interpretation of the results of the analysis. The first impression is that the superficial density is just twice the normal; but a closer view of the matter does not permit of this sweeping conclusion, for the film may be of gradually changing density and  $2\epsilon$  thick, in which case all change in density observed would be merely change in the average density of the film itself.

In accordance with the theory outlined above let it be assumed that the *active* portion of the vapor molecules lie on a spherical surface of average radius  $r + \Delta r$  and that the active portion of the liquid molecules acting normally through the same spherical surface of radius  $r$  occupy a spherical surface of average radius  $r - \Delta r$ . Those molecules outside of the average range of action, either of liquid or of vapor, will be in homogeneous equilibrium and will take no *active* part in the phase equilibrium, unless there should be some other source of disturbance than curvature.

Poynting and Thomson's equation, referred to above, showing the relation of the vapor-pressure,  $\omega'$  in equilibrium with a drop of radius  $r$ , and the vapor-pressure,  $\omega$ , of the same vapor in equilibrium with a plane liquid surface, is

$$\log_e \frac{\omega'}{\omega} = \frac{2\gamma\sigma}{\rho\omega r} \dots \dots \dots (B)$$

where  $\omega'$  is the vapor-pressure at the convex surface of a liquid drop of radius  $r$ ,  $\omega$  the vapor-pressure for a plane

surface,  $\sigma$  the vapor density,  $\gamma$  the surface-tension and  $\rho$  the liquid density. From this equation we can calculate the ratio  $\omega'/\omega$  for any assumed value of  $r$  and substitute the result in (A) and calculate the value of  $\Delta r$ .

To facilitate the computation and the testing of the constancy of  $\Delta r$  for different values of  $r$ , the equation may be considerably simplified. For brevity write  $\Delta r/r = x$ , and for the value of  $x$ , when  $r = 1$ , write  $\epsilon$ . Then we have

$$\log_e \left( \frac{1+x}{1-x} \right)^2 = 2 \log_e \left( \frac{1+x}{1-x} \right) = 4 \left( x + \frac{1}{3}x^3 + \frac{1}{5}x^5 + \dots \right) = \frac{2\gamma\sigma}{\rho\omega r} \quad (C)$$

Now when  $r = 1$  and  $x = \epsilon$ , all the powers of  $x$  above the first will vanish, as may easily be tested. Hence, when  $r = 1$

$$\epsilon = \frac{\gamma\sigma}{2\rho\omega_{(r=1)}} \dots\dots\dots (D)$$

In order to test the agreement of the two functions, the geometric and the dynamic, for all values of  $r$ , we may write (C) in the form

$$\frac{\gamma\sigma}{2\rho\omega r} = \frac{\Delta r}{r} + \frac{1}{3} \left( \frac{\Delta r}{r} \right)^3 + \frac{1}{5} \left( \frac{\Delta r}{r} \right)^5 + \dots\dots\dots (E)$$

which, if identical, should be true for all values of  $r$  if  $\Delta r$  is independent of  $r$ . Inspection shows that all values of  $\Delta r/r$  less than 1/10 cannot affect the third significant figure; and since  $\Delta r$  is seldom larger than  $10^{-7}$  cm, values of  $r$  may vary between  $\infty$  and  $10^{-8}$  cm without appreciable change in the value of  $\epsilon$ . For values of  $r$  less than three or four times the range of molecular action,  $\epsilon$ , the two functions begin to diverge slowly, differing by nearly 10 percent when  $\epsilon/r = 1/2$ . As previously pointed out this may indicate a change in the average density of the surface as the drops become almost of molecular dimensions when the film, or surface portion, becomes an appreciable part of the whole drop. The practical constancy of  $\epsilon$  and its practical independence of the size of the drop of liquid, lead us to conclude that it represents a characteristic property of the substance only slightly dependent upon the curvature which enables us to determine its value.

As an illustration, the value of  $\varepsilon$  for water at  $0^\circ\text{C}$  will be computed, and its value for a few additional substances at ordinary temperatures given, in order better to show its characteristics. On the last page will be given some additional values determined from two different formulas so that their differences may be compared for the necessary data used in the computations. Ramsay and Shields'<sup>1</sup> values were used for the surface-tensions and for both vapor and liquid densities so far as possible. For vapor-pressures, Winkelmann's *Handbuch* Vol. 3, *Wärme*, was used in many instances. In one or two instances other reliable tables were consulted. For water at  $0^\circ\text{C}$ ,  $\gamma = 73.2$ ;  $a = 4.9 \times 10^{-6}$ ,  $\rho = 1$ ,  $r = 1$ ,  $\omega = 0.46 \times 980.6 \times 13.6$ . From these values,  $\varepsilon = 2.924 \times 10^{-8}$  on computing its value from

$$\varepsilon = \frac{\gamma\sigma}{2\rho\omega}$$

Now, if for brevity we take  $\varepsilon$  as  $3.0 \times 10^{-8}$  and substitute in the more general formula (D), we find that the largest value of  $r$  that affects appreciably the value of  $\varepsilon$  is  $r = 10^{-7}$  which makes  $\frac{\Delta r}{r} = \frac{3}{10}$  and the sum of the next two terms 0.0949, an increase of a little over 3 percent. Hence when  $r = 10^{-7}$ ,  $\varepsilon = 2.83 \times 10^{-8}$  instead of  $2.92 \times 10^{-8}$ , the value when  $r = 1$ . A similar percentage of variation for very small drops may be expected in all cases; but unless otherwise stated the values when  $r = 1$  will be given. The following list contains the value of  $\varepsilon$  in centimeters for a few substances at the stated temperatures:

Water at $0^\circ\text{C}$ ,	$2.92 \times 10^{-8}$
Alcohol at $20^\circ\text{C}$ ,	$2.43 \times 10^{-8}$
Ether at $20^\circ\text{C}$ ,	$3.65 \times 10^{-8}$
$\text{CS}_2$ at $19.4^\circ\text{C}$ ,	$4.07 \times 10^{-8}$
$\text{CCl}_4$ at $20^\circ\text{C}$ ,	$5.40 \times 10^{-8}$
Benzol at $80^\circ\text{C}$ ,	$3.42 \times 10^{-8}$

Before proceeding further with regard to the value of  $\varepsilon$  as thus determined another aspect of the theory should be

<sup>1</sup> Zeit. phys. Chem., 12, 455 (1893).

presented. Since  $\omega$  represents the ordinary vapor-pressure it may be expressed in terms of the general gas equation and must hold to the same extent that the general gas equation holds for the vapor of the given substance. Using the same symbols and meanings as in previous equations we have for the vapor-pressure

$$\omega = \sigma \frac{R}{m} T \quad (\text{gas equation}) \dots \dots \dots (F)$$

where  $R$  is the gas constant, 82600000 which for a given vapor or gas must be divided by the molecular weight  $m$  of the substance, and  $T$  is the absolute temperature. If this value of  $\omega$  be substituted in the equation (D) and reduced we get

$$\frac{\gamma}{2\epsilon} = \rho \frac{R}{m} T \quad (\text{liquid equation}) \dots \dots \dots (G)$$

where  $R$ ,  $m$  and  $T$  have the same values as in (F).

Here  $\rho \frac{R}{m} T$  represents what in a former paper<sup>1</sup> was described as the "intrinsic pressure" of the liquid. But this equation throws an additional light on the subject. In the gas equation  $\omega$  represents the *pressure* per unit area exerted by the vapor. In the liquid equation,  $\gamma$  is the tension in a film of a certain thickness. The ratio of this tension to the thickness of the film must be equal to the tension per unit area of cross-section of the film. If  $2\epsilon$ , twice the radius of action, *i. e.*, the diameter of the sphere of action, may be regarded as the thickness of the film, then  $\gamma/2\epsilon$  is the tension per unit cross-section of the film in which the phenomena of surface-tension have their seat. But this value,  $\gamma/2\epsilon = \rho \frac{R}{m} T$  is exactly the value of the intrinsic pressure of the liquid. The intrinsic pressure of a liquid may be concisely defined as that pressure which the liquid would exert if it were a perfect gas having the same temperature and density as the liquid. This relation between the surface-tension and the gas equation would tend to show that the tension per unit area of cross-

<sup>1</sup> Jour. Phys. Chem., 14, 7, 651 (1910).

section of the film is numerically equal, but opposite in sign, to the pressure the liquid would exert if it were a perfect gas having the same temperature and density as the liquid in the film.

In order to decide on the significance of  $\epsilon$  as applied to the general gas equation we may approach the question from another point of view. If in accordance with the generally accepted theory of the molecule, we assume that the average energy of translation of a molecule depends only on the absolute temperature and is independent of phase (liquid or vapor), then in consonance with the third Newtonian law, the molecular attraction observed in liquid films must be merely the reaction of what is observed in the free molecule when it is out of range of molecular attraction and exerts a pressure on the retaining walls. If this be true, then the ratio,  $\sigma/\rho - n_1/n_2$ , is simply the ratio of the number of molecules acting normally through unit area in one direction. Now comparing the two equations (F) and (G) we are forced to conclude that if  $\rho$  is the average density in the film,  $2\epsilon$  must be its cross-section. If on the other hand  $\epsilon$  is the cross-section then the density in the film is twice the usual density of the liquid. This latter supposition can hardly be reconciled with the close agreement, down to almost molecular range, of the geometric function with the dynamic function which differ from each other, in the case of water, only 3 percent for drops as small as  $10^{-7}$  cm and in no case do they differ more than 10 percent for values of  $r$  greater than  $2\epsilon$ . In any event the thickness of the superficial film lies between  $\epsilon$  and  $2\epsilon$  as the limiting values.

This may be shown in another way as follows: In case of a liquid whose vapor-pressure is negligibly small, let us suppose that the molecular attractions are just sufficient to neutralize the pressure which the molecules would exert if there were no molecular attractions. That is, the molecular attractions in a liquid will be assumed to be numerically equal, but opposite in sign, to the pressure the substance would exert at the same temperature and density, if it were a

perfect gas. Assuming the temperature to be constant, we have to compare the two effects, attraction and pressure, on equal areas with equal densities.

By Boyle's law,  $\omega/\sigma = K$  (say). With  $\sigma = 1$ ,  $\omega = K$  at the same ratio. Now if  $\gamma$  is the attraction in a liquid film 1 cm long and  $\tau$  cm thick, of density  $\rho$ , then  $\gamma/\tau$  is the attraction per unit area, and  $\gamma/\tau\rho$  is the attraction per unit area for unit density, or  $\gamma/\tau\rho = -K$  by hypothesis.

Therefore

$$\frac{\gamma}{\tau\rho} + \frac{\omega}{\sigma} = 0$$

or, solving for  $\tau$

$$\tau = -\frac{\gamma\sigma}{\rho\omega} = 2\varepsilon$$

the negative sign merely indicating that  $\gamma$  and  $\omega$  are opposite in sign.

The result shows that the above assumptions are justified if the thickness of the film is  $2\varepsilon$ . But from equation (G) this thickness indicates that the density in the film is the same as the ordinary density of the liquid.

The slight forces displayed in the surface films of liquids may in consequence of their extreme thinness, give us a totally inadequate conception of the magnitude of the molecular forces concerned. Although the surface-tension exhibited by water at the temperature of  $0^\circ\text{C}$  is only 73.2 dynes per linear cm of the film, yet the actual tensile strength per unit area of cross-section of the film is about one-fourth that of the iron or mild steel used in the shells of steam boilers, although its density is not much more than one-eighth as great as that of the iron. If in addition, allowance were made for the difference in density and we compared the tensile strength of liquid water at  $0^\circ\text{C}$  with steel containing the same mass per unit length, the tensile strength of a water film would be almost exactly that of the tensile strength of the best quality of piano wire.

In this connection a remark on the importance of rigidity



in enhancing tensile strength may not be amiss. Soft iron displays, only in a very much less degree than water, the property of elongation, or flowing, so that the cross-section diminishes under a stretching force. With liquids, this ability to change shape under stress prevents our perceiving the actual force necessary to separate two portions of liquid against the molecular attractions. When this elongation by diminishing cross-section is prevented we may perceive and measure the intensity of the molecular attractions.

Since, as has been shown, the main distinction between surface-tension and vapor-pressure is one of sign and phase—the force changing sign as the substance changes phase—we should be able to compute, approximately at least, the value of  $\varepsilon$  from the surface-tension and the general gas equation. In case of liquids at such low temperatures that the vapor-density and vapor-pressure are too small to be measured accurately,  $\varepsilon$  may be found from the equation

$$\varepsilon = \frac{m\gamma}{2\rho RT} \dots\dots\dots (H)$$

where  $m$  is the molecular weight of the substance as determined from its vapor. Applying this equation to mercury at 0° C at which temperature the vapor-pressure and vapor-tension are too small to be measured accurately, we find  $\varepsilon = 17 \times 10^{-8}$  and the intrinsic pressure 1525 atmospheres, assuming the molecular weight to be 198.5 and  $\gamma = 527$ .

The peculiar relation of surface-tension to vapor-pressure and also to the intrinsic pressure of substances may perhaps, be more strikingly shown by a slight transformation of the two equations (F) and (G). Since mass is the product of volume and density we may in each equation substitute the molecular volumes, the one liquid, the other vapor. They then become

$$\frac{\gamma}{2\varepsilon} V'_m = RT = \omega V_m$$

where  $V'_m$  is the volume of a gram mol. of liquid and  $V_m$  is

the volume of a gram mol. of the same substance in the vapor phase, or, omitting the  $R T$

$$\frac{\gamma}{2\varepsilon} V'_m = \omega V_m.$$

Although the theory from which the value of  $\varepsilon$  is derived, has at first sight no immediate relation to the general gas equation, it is evident that the two equations (D) and (H) are closely related. They reduce to an identity when the value of  $\varepsilon$  from one is substituted in the other. The equation (H) was obtained from (D) by substituting for  $\omega$  its value,  $\sigma \frac{R}{m} T$ , from the general gas equation. However, they are not identical experimentally as may easily be seen as follows: The ratio,  $\omega/\sigma$  for a vapor, may be obtained directly from experiment. The same is true for the ratio  $\gamma/\rho$  for the liquid phase. If now we find the ratio of the two above experimentally determined ratios and call it  $2\varepsilon$  then for the given pair of values we have identically,  $2\varepsilon \times \frac{\omega}{\sigma} = \frac{\gamma}{\rho}$  of necessity, for that pair of values. Now if not functionally related,  $\varepsilon$  as a ratio found from experimental values, may be a constant, a variable or merely an arbitrary ratio, having unrelated values for each pair of ratios. But in this case,  $\varepsilon$  is functionally related to the general gas equation from the fact that it is the ratio of two ratios *one* of which is manifestly a function of the general gas equation, since  $2\varepsilon$  is computed from, and is equal to,  $\gamma/\rho \times \frac{\sigma}{\omega}$ . It has also been shown that  $2\varepsilon$  correctly represents the dynamical value of  $\frac{\gamma\sigma}{\rho\omega}$  over a very wide range of values. Therefore it must satisfy the general gas equation just as exactly and to the same degree as its equal  $\frac{\gamma\sigma}{\rho\omega}$ , for the substance, temperature and pressure being the same,  $\frac{\gamma}{2\varepsilon\rho}$  corresponds with, and is equal, to  $\frac{\omega}{\sigma} = \frac{R}{m} T$ .

For low temperatures where the vapor-density  $\sigma$ , and the vapor-pressure  $\omega$  cannot be measured accurately, the value of  $\epsilon$  from the general gas equation is the more reliable value of the two. Take the case of alcohol at 20° C. The different values of  $\sigma$  and  $\omega$  as given by good and reliable observers may be made to give values of  $\epsilon$  which differ over 10 percent. For instance, Ramsay and Shield's<sup>1</sup> value for  $\sigma$  is 0.0001 while if computed from the specific volume given by Battelli in Winkelmann<sup>1</sup> the value is 0.000114, a difference of 14 percent.

In conclusion a number of examples in tabulated form are given. Two values of  $\epsilon$  are given,  $\epsilon_1$ , computed from equation (D) and  $\epsilon_2$ , as computed from equation (H). Some of the irregularities observed are evidently due to inaccuracy in the experimental data. The data from which the computations were made are given fully in order that the effect of introducing other experimental values regarded as more reliable, may be tested.

---

<sup>1</sup> Loc. cit.

COMPUTED VALUES

Name of substance. (Mol. wt. = <i>m</i> )	Temperature C	Molecular range $\epsilon \times 10^8$ cm		$\gamma + 2\epsilon$ , surface tension in atmospheres per cm <sup>2</sup> cross-section	Intrinsic pres- sure, $\rho \frac{R}{m} T$ in atmospheres
		$\epsilon_1$	$\epsilon_2$		
Water ( <i>m</i> = 18)	0°	2.93	2.92	1236	1236
	20°	2.62	2.63	1328	1324
	60°	2.16	2.135	1470	1485
Ethyl alcohol ( <i>m</i> = 46)	100°	1.78	1.74	1580	1620
	20°	2.77	2.74	392	396
	80°	1.76	1.76	461	461
Methyl alcohol ( <i>m</i> = 31.8)	20°	1.96	1.93	587	593
	80°	1.33	1.23	621	669
	100°	1.19	1.06	612	680
Methyl formate ( <i>m</i> = 59.6)	20°	3.21	3.12	380	389
	60°	2.31	2.21	397	414
	100°	1.66	1.47	377	433
Ethyl ether ( <i>m</i> = 73.6)	20°	3.74	3.51	217	232
	80°	3.35	3.33	295	299.5
	150°	3.09	2.95	282	296
Chlorobenzene ( <i>m</i> = 111.6)	20°	5.4	5.12	234	247.5
	19.4°	4.07	4.17	407	399
	0°	—	17.0	—	1525

## EXPERIMENTAL DATA USED IN THE COMPUTATION

Name of substance	Temperature C	Surface tension $\gamma$	Liquid density gms. per cc $\rho$	Vapor-density gms per cc $\sigma$	Vapor-pressure cm Hg $\omega$
Water	0°	73.2	1	$4.9 \times 10^{-6}$	0.46
	20°	70.6	0.9983	$17.2 \times 10^{-6}$	1.74
	60°	64.27	0.9834	$131.0 \times 10^{-6}$	14.88
	100°	57.15	0.9586	$606.0 \times 10^{-6}$	76.0
Ethyl alcohol	20°	22.03	0.7626	$114.0 \times 10^{-6}$	4.45
	80°	16.61	0.7377	0.0017	81.3
Methyl alcohol	20°	23.02	0.7905	$169.0 \times 10^{-6}$	9.6
	80°	16.70	0.7355	0.0021	134.0
	100°	14.80	0.7140	0.0040	262.0
Methyl formate	20°	24.62	0.9745	0.0016	47.6
	60°	18.58	0.9133	0.0060	199.0
	100°	12.90	0.8452	0.0171	577.0
Ethyl ether Benzene Chlorbenzene Carbontetrachloride Carbonbisulphide	20°	16.49	0.7143	0.00187	43.28
	80°	20.28	0.8127	0.0027	75.5
	150°	17.67	0.9599	0.0054	120.6
	20°	25.68	1.594	0.0008	8.96
	19.4°	33.58	1.264	0.001216	29.8

State College, Pa.,  
January 1, 1912

## ELECTROLYTIC REDUCTION OF NITROBENZENE WITHOUT A DIAPHRAGM

BY E. F. FARNAU

Up to a few years ago, save for a single series of experiments by Dieffenbach,<sup>1</sup> and some patents by Meister Lucius and Brüning,<sup>2</sup> no electrolytic reduction of nitrobenzene has been carried out without the use of a diaphragm. In Dieffenbach's experiments nitrobenzene in a neutral solution was reduced at the cathode to  $\beta$ -phenylhydroxylamine, and this in turn was oxidized at the anode to nitrosobenzene. The electrodes used were non-attackable. Meister Lucius & Brüning claim to make azobenzene and azoxybenzene by electrolyzing in an alkaline solution without a diaphragm, using a small anode and a large cathode. Recently some work without a diaphragm, and with soluble anodes has been done in this laboratory by Snowdon,<sup>3</sup> on nitrobenzene suspended in aqueous solutions.

The advantages of a one-solution electrolyte are obvious: The diaphragm—generally a porous cup—increases the resistance of the cell, and much of the reduction product is lost due to adsorption in the pores of the cup. Further, the soluble anode prevents oxidation of the reduction product, and lowers the decomposition voltage in the cell. Finally, a suspension of nitrobenzene in aqueous solution eliminates the use of organic solvents which may introduce complications.

Allen<sup>4</sup> in this laboratory has determined the nature and yield of the various reduction products obtained from nitrobenzene by the action of sodium hydroxide and ferrous solutions, and has found that aniline is obtained in good yield

<sup>1</sup> Chem. Centralblatt, [5] 2, 1, 911 (1908).

<sup>2</sup> Zeit. Elektrochemie, 8, 217 (1902).

<sup>3</sup> Jour. Phys. Chem., 15, 797 (1911).

<sup>4</sup> Ibid., 16, 89 (1912).

with neutral solutions at room temperature. It was of interest to seek an electrolytic analogue of this reaction. Electrolysis of a nitrobenzene suspension in sodium sulphate solution between iron electrodes offered such an example.

In order to simplify the apparatus as much as possible, an 8½" length of 2½" iron pipe capped at one end served at once as container and as cathode; and a stirrer with a shaft of ¼" tool steel and paddles of twisted iron wire was made anode. The shaft fitted into a bearing-metal journal set in a cork stopper closing the vessel. The stirrer was actuated by a D. C. motor, the speed being from 1000-1500 r. p. m. The cell was placed in series with a lamp bank resistance and an ammeter, and in parallel with a voltmeter. The 110 volt D. C. line supplied the current.

The electrolyte consisted of 250 cc 10 percent sodium sulphate and 10 cc (equal to 12 grams) nitrobenzene. Little care was taken to keep the temperature constant, the runs usually beginning at 25° and ending at 35°. After completion of the run, the solution with its finely divided suspension of orange-red iron oxide and oily drops of aniline and unaltered nitrobenzene was steam-distilled until the drops condensing were clear. The distillate, having been made strongly acid with conc. hydrochloric acid, was diluted to exactly 250 cc, and allowed to settle; 10 cc portions after addition of excess of 10 percent potassium bromide, were titrated with *n*/10 potassium bromate, using starch-iodide solution as external indicator.<sup>1</sup> Some of the tribromaniline precipitated in one of these determinations was dried and its melting point found to be 117°-118°, agreeing closely with that given by Fritzsche,<sup>2</sup> 117°. The nitrobenzene settling out of the acid solution was decanted into a graduated test tube, in which its volume was determined. The stirrer was weighed before and after each run.

The results are given in Tables I and II.

<sup>1</sup> Vaubel: Phys. Chem. Meth. quant. Best. org. Verbdg. Bd., II, 168.

<sup>2</sup> Liebig's Ann., 44, 291 (1842).

TABLE I

No. of run	I	II	III
Stirrer, r. p. m.	1200	1500	1200
Temperature	25°-35°	25°-35°	25°-34°
Anode loss	—	8.6 g.	7.8 g.
Corrosion efficiency	—	98%	104%
Length of run, min.	84	170	135
Current (amperes)	3.5	3.0	3.0
Amp/dm <sup>2</sup> (anode)	1.7	1.5	1.5
Amp/dm <sup>2</sup> cathode	1.5	1.3	1.3
Voltage	10.5-8.0	6.0-4.9	3.5-1.5
Nitrobenzene taken	12 g.	12 g.	12 g.
Nitrobenzene reduced	6.16 g.	7.03 g.	6.41 g.
Nitrobenzene recovered	4.44 g.	3.60 g.	4.01 g.
Chemical efficiency	88%	89%	86%
Current eff. calc. 1	242%	216%	247%
Current eff. calc. 2	162%	144%	165%
Current eff. calc. 3	81%	72%	82%

Calc. 1 is on the basis that only ferrous hydroxide acts as reducing agent. Calc. 2 is on the basis that only cathodic reduction occurs. Calc. 3 is on the basis that both ferrous hydroxide and cathodic hydrogen act as reducing agents. The low voltage in Exp. III was due to improvement in the brush contact for the stirrer shaft. Exp. IV, Table II, was made in order to determine the amount of purely chemical reduction of nitrobenzene by iron in the presence of sodium sulphate. In Exp. V ferrous sulphate in equivalent concentration was substituted for the sodium sulphate.

TABLE II

No. of run	IV	V
Stirrer, r. p. m.	1500	1500
Temperature	25°	26°
Anode loss	0.8 g.	0.3 g.
Length of run, min.	2160	190
Nitrobenzene taken	12 g.	12 g.
Nitrobenzene reduced	1.67 g.	0.44 g.
Reduction, g./hr.	0.039	0.14



**Conclusions**

(1) Electrolytic reduction of nitrobenzene to aniline without the use of a diaphragm is feasible; indeed high current and chemical efficiencies are obtained, and at a comparatively low voltage.<sup>1</sup>

(2) Both the ferrous hydroxide and cathodic hydrogen take part in the reduction, the former being oxidized to ferric hydroxide.

(3) Practically no other reduction product than aniline is obtained at room temperature.

This research was suggested by Professor Bancroft, and carried out under his supervision; I wish to express my great appreciation of his kindly advice and criticism.

*Cornell University,  
April 18, 1911*

---

<sup>1</sup> Compare the current and voltage in experiments where non-attackable anodes and porous cups were employed: 9-15 amps., 10 volts. Elbs and Silbermann: *Zeit. Elektrochemie*, 7, 589 (1901); 2-2½ amps., 3½ volts. Elbs: *Zeit. Elektrochemie*, 4, 472 (1895); 2 amps., 5 volts. Löb: *Zeit. Elektrochemie*, 4, 431 (1897).

## THE DIELECTRIC CONSTANT OF LIQUID ARSINE

BY HERMAN SCHLUNDT AND O. C. SCHAEFER

The dielectric constants of solid ammonia, liquid phosphine and stibine were reported in an earlier communication.<sup>1</sup> We have now determined the dielectric capacity of liquid arsine and have thus completed the values for this series of hydrides.

The measurements were made with the Schmidt modification<sup>2</sup> of the Drude apparatus for determining dielectric capacities. The cells were of the U-form similar to those used formerly.<sup>3</sup> They were calibrated with the standard solutions of benzene and acetone just before and after the sample of liquid arsine was measured. Two independent determinations were made with different samples of arsine and in cells whose dielectric capacity differed somewhat. The stationary electric waves produced by the apparatus in air measured 72 cm.

The samples of arsine were prepared by the method of Saunders:<sup>4</sup> Dilute sulphuric acid was allowed to flow slowly from a drop funnel on an alloy of sodium and arsenic contained in a suitable generator. The gases evolved were passed through a phosphorus pentoxide tower and the arsine was condensed in a receiver immersed in a bath of solid carbon dioxide and ether, which could be kept under greatly reduced pressure. From the receiver the liquid arsine was distilled directly into the measuring cells, which were then sealed off. The generator, drying trains, condenser, measuring cell, manometers, etc., were sealed together, and the entire apparatus was exhausted to 0.1 mm before arsine was generated.

The dielectric capacity was measured at 15° and at approximately -70°, the liquid arsine being under its own

<sup>1</sup> Palmer and Schlundt: *Jour. Phys. Chem.*, 15, 381 (1911).

<sup>2</sup> Drude's *Ann.*, 9, 919 (1902).

<sup>3</sup> *Jour. Phys. Chem.*, 13, 671 (1909).

<sup>4</sup> *Chem. News*, 79, 66 (1899).

vapor pressure. Two values were obtained with different cells at 15° and these were the same, namely 2.05, but at about -70° the values were respectively 2.66 and 2.83. The dielectric constant thus increases approximately 0.4 percent per degree cooling below 15°.

The following table gives the dielectric constants of this group of liquid hydrides at -50° and 15°.

	-50°	15°
Ammonia	22.7	15.9
Phosphine	2.6	2.88 <sup>1</sup>
Arsine	2.58	2.05
Stibine	2.58	1.81 <sup>1</sup>

*Chemical Laboratory,  
University of Missouri,  
January, 1912*

<sup>1</sup> Extrapolated. Cf. Jour. Phys. Chem., 15, 381 (1911).

## NEW BOOKS

**Traité de Chimie générale.** By Walther Nernst. Translated from the sixth German edition by E. Corvisy. Part II. 17 × 25 cm; pp. 422. Paris: A. Herman et Fils, 1912. Price: paper, 10 francs.—The first volume has already been reviewed (16, 172). The second volume contains the section on the transformation of matter and the ones on the transformations of energy. It is interesting to note the way in which the subjects have developed. In the pages on dyeing we still have Witt's theory of solid solution, but we also find, p. 75, the following paragraph: "Nevertheless it is probable that adsorption phenomena, and perhaps chemical phenomena, play a part in the taking up of coloring matter by the fibre, so that we are not dealing with a simple case of the distribution of a substance between two solvents. This view is confirmed by the fact that we get abnormal values for the molecular weights of substances absorbed in the fibre."

We flatter ourselves with the belief that the scientific man values truth highly and is always seeking after it and we find Nernst, in successive editions, saying that methyl orange is a weak basic indicator, p. 107, while Ostwald, with equal regularity, asserts that it is a strong acid indicator. Nernst is right in the matter, but the papers of Küster, Waddell, and Stieglitz have practically no effect and nearly all writers of books follow Ostwald blindly.

On p. 115, Nernst cites the case of alumina dissolving in caustic soda and causing no change in the vapor pressure. He follows Noyes and Whitney in deducing therefrom the existence of  $\text{KAlO}(\text{OH})_2$  or of  $\text{KAlO}_2$ . These were the only possibilities at the time that the work was done, but to-day one must consider the possibility of the alumina being present in colloidal form rather than in true solution.

Nernst is now giving more space to reaction velocity than he did in the early editions and this is a very welcome change. The reviewer is unable to agree with the view, p. 158, that a catalyzer cannot displace the equilibrium. Any substance which acts at all as a solvent can and will change the equilibrium. Since it also changes the reaction velocity it is difficult to see how one can or why one should frame a definition which shall exclude it.

One must also object to the theorem of the replacement of phases, p. 254: "If two phases are in equilibrium with a third relatively to a given reaction at a given temperature they will be in equilibrium with each other relatively to the same reaction at the same temperature." As I have previously pointed out, a saturated solution of salt in alcohol is not in equilibrium with a saturated solution of salt in water although the two phases are in equilibrium with a third phase, salt, relatively to a given reaction at a given temperature.

In the section on transformations of energy, Nernst has devoted a good deal of space, very properly, to his theorem for calculating equilibrium relations from thermal data. The reader will find this a very valuable portion of the book.

The chapter on photochemistry is very bad. Nernst believes that the latent image is the sub-bromide; he postulates the absolute accuracy of Bunsen and

Roscoe's formula; and he is very vague as to the conditions under which light acts.

Wilder D. Bancroft

**Messungen elektromotorischen Kräfte galvanischer Ketten mit Wässerigen Elektrolyten.** By R. Abegg, Fr. Auerbach and R. Lather. (*Abhandlungen der Deutschen Bunsen-Gesellschaft, No. 5.*) 18 × 26 cm; pp. 213. Halle: Wilhelm Knapp, 1911. Price: paper, 8.40 marks.—In this volume the authors give:

1. Literature references to measurements of the electromotive forces of galvanic cells with a statement of the cell measured but with no numerical data. These references have been arranged systematically and chronologically, and are as complete as possible.

2. A systematically arranged selection of the most reliable data presented in a uniform manner and giving the facts without complications by assumptions or by hypotheses.

3. Tables of the most probable values of the single potentials.

The data given refer only to cells with water as solvent, and the only variables considered are the temperature of the cell and the compositions of the electrodes, electrolytes, and solid or gaseous depolarizers. The authors have excluded all measurements where variations are due to gravity, mechanical treatment of electrodes or electrolytes, surface tension, relative motion of electrode and electrolyte, temperature differences within the cell, action of light or other radiations, and polarization by external electromotive forces.

The book is well worth the enormous amount of labor spent upon it. It is absolutely necessary as a reference book. In order to keep the work up-to-date, all people measuring electromotive forces are requested:

1. To give the actually measured electromotive forces and not merely the values deduced from them.

2. To give clearly the nature, character and preliminary treatment of the electrodes; to state accurately the composition of the electrolytes, the depolarizers and the connecting solutions, giving the analytical or synthetical data and not merely the concentration of the ions; to state the temperature; and to avoid confusion as to which is the positive pole.

3. To present the data, so far as possible, in the form adopted in this book.

4. To give the electrode potentials either in terms of the normal hydrogen electrode as zero in which case the symbol  $e_H$  is to be used; or in the terms of the normal calomel electrode as zero (not as 0.56) in which the symbol  $e_c$  is to be used.

5. To give the sign of a single potential so that it corresponds to the charge of the electrode in question with reference to the normal electrode (negative for  $Zn | Zn^{++}$ , positive for  $Ag | Ag^+$  and for  $(Pt) | Cl_2, Cl^+$ ).

6. To send reprints to Dr. Fr. Auerbach, Karlsruhe Str. 30, Berlin-Halensee, Germany.

Wilder D. Bancroft

**Thermodynamik der Atmosphäre.** By Alfred Wegener. 14 × 23 cm; pp. viii + 331. Leipzig: J. A. Barth, 1911. Price: paper, 11 marks; bound, 12 marks.—This volume is intended as the first in a series to constitute a complete "Physics of the Atmosphere"; but the author admits regretfully that there is no telling when or whether the other volumes will appear. The subject is treated

under the following heads: introduction; general thermodynamics of ideal gases; special thermodynamics of adiabatic processes; physics of the clouds. The author considers, p. 7, that the upper limit of ordinary clouds is about ten kilometers. At about seventy-five kilometers we get the limit of the ordinary sunset effects. Above this level we change from the nitrogen atmosphere to the hydrogen atmosphere which latter extends up to an estimated height of about 214 km, above which level the "blue light" also disappears. The shooting stars are mostly in this hydrogen atmosphere because we call them meteorites if they get down into the nitrogen atmosphere. The northern lights that we see in temperate zones are apt to start in the hydrogen atmosphere and to run down into the nitrogen atmosphere. The space between the 214 km level and the 500 km level is called by the author the geocoronium atmosphere because of the alleged presence of the hypothetical gas, geocoronium. Between 400 km and 500 km we seem to get a special form of northern lights which show no signs of rays. The author considers these, p. 11, as cathode rays which have not been absorbed by the nitrogen atmosphere and which are going away from the earth. The noctilucent clouds (15, 88) are considered by the author, p. 18, as due to the eruption of Krakatoa, in which case they will soon cease to exist. They are supposed to be ice crystals, as the author believes that the enormous outpouring of hydrogen and water vapor carried considerable quantities of the latter clean through the so-called nitrogen atmosphere.

On p. 50 there is an account of the remarkable way in which sound-waves traveled after an explosion of dynamite. The sound was heard for about thirty kilometers from the place of the explosion. Then came a silent zone about one hundred kilometers wide in which nothing was heard. Outside of this there was another zone, perhaps fifty kilometers wide, in which the sound of the explosion was heard.

Attention should be called to the superb photographs of clouds with which the book is ornamented. The one on p. 145 is especially striking.

*Wilder D. Bancroft*

*Der elektrische Ofen.* By J. Bronn. (*Monographien über angewandte Elektrochemie, xxxiv Band.*) 17 × 24 cm; pp. xiii + 360. Leipzig: Wilhelm Knapp, 1910. Price: paper, 22 marks.—The book deals with electric furnaces for experimental purposes and for technical use in making refractories, porcelain, glass and quartz glass. While the author advocates the use of the scientific pyrometers in certain cases, he is also strongly in favor of Seger cones under some circumstances. As an absolute measure of temperature, the Seger cone is worthless because the temperature at which it collapses varies with the rate of heating. In work with pottery this is an advantage because the temperature at which pottery should be fired also varies with the rate of heating.

There is a very interesting chapter on the properties of clays and an excellent one on small electric furnaces. One chapter is devoted to fused magnesia and to the various forms of fused alumina known under the names of alundum, electrite, diamantine and dynamidon. The next chapter deals with carborundum, silundum and siloxicon.

Glass is treated at some length and the chapter on properties is very interesting. The one on the use of the electric furnace in the preparation of glass

is perhaps as good as it could be made considering the state of the art, which has not yet got beyond the experimental stage. The chapters on fused quartz practically constitute a monograph.

Wilder D. Bancroft

**Die elektrolytischen Prozesse der organischen Chemie.** By Alexander Moser. (*Monographien über angewandte Elektrochemie, xxxvi Band.*) 17 × 24 cm; pp. xvi + 205. Halle: Wilhelm Knapp, 1910. Price: paper, 10 marks.—

This book was begun by, and has been carried on under the supervision of, Haber, which is in itself a guarantee. There is an introductory chapter on general principles and then we have chapters on the electrolysis of ionized compounds, on electrolytic oxidation, on electrolytic substitution, and on electrolytic reduction. The behavior of platinum anodes, p. 60, is ascribed to oxide films, and it is pointed out that there is still much work to be done along this line. Schlötter's work on the electrolytic production of aldehyde, p. 65, is interesting and should not have been buried in a dissertation. The electrolytic oxidation of toluene to benzaldehyde, p. 74, is interesting because it takes place when aqueous sulphuric acid containing acetone is used as solvent. There is an excellent discussion, p. 107, of excess voltage. It does not bring us out anywhere; but that is not the author's fault. There is also an excellent discussion, p. 122, of the specific effect of the cathode metal on electrolytic reductions.

On p. 161, attention is called to the fact, first pointed out by Buchner, that the hydrogen going to waste during the electrolytic production of bleaching powder in Germany alone would suffice to make nine thousand tons of aniline or three-quarters of the world's annual consumption.

Wilder D. Bancroft

**Galvanostegie, I. Ueber elektrolytische Metallniederschläge.** By M. Schlötter. (*Monographien über angewandte Elektrochemie, xxxvii Band.*) 17 × 24 cm; pp. xiv + 257. Leipzig: Wilhelm Knapp, 1911. Price: paper, 12 marks.—

This is not intended as an introductory book; but is written for the benefit of the man already interested in electroplating. A good deal of space is given to the theory of electrolytic deposits and the author lays special stress on the effect of colloids. He is undoubtedly right in ascribing the effect of aluminum sulphate in zinc and copper baths, p. 38, to the colloidal alumina which is carried to the cathode. He does not seem to be on so safe ground when he assumes, pp. 51, 107, that zinc hydroxide acts as a positive colloid in caustic soda solution. It may be that the zinc moves to the cathode under those conditions; but one would like to see proof of this.

The metals are taken up in the order: nickel; iron; zinc; copper; silver; gold; platinum; cadmium; tin; antimony; arsenic. Then there are ten pages on the plating of aluminum, followed by thirty pages on the precipitation of alloys. It is all very well done and the author has given as many explanations as one could possibly expect; he has also covered the literature well. Electrolytic galvanizing is treated very fully, but the rest of the book is equally good. It is by far the most valuable book on the subject which has been written.

Wilder D. Bancroft

**Introduction to General Chemistry.** By J. T. Stoddard. 14 × 20 cm; pp. xviii + 432. New York: The Macmillan Co., 1910. Price: \$1.60.—In

the preface the author says: "The many text-books on introductory chemistry which have appeared in the last few years are evidence of the differences of opinion as to the best mode of presenting the subject. This book is one more attempt to solve the problem. I am well aware of imperfections in the scheme, but trust it is a step in the right direction. My aim is to develop the subject in a natural manner, introducing new facts and ideas gradually, and discussing their relations and the theoretical explanations at points where such discussions will be welcomed by the student as summing up and interpreting what has gone before. So far as possible, the progress is from the familiar to the unfamiliar, from the known to the unknown."

This is excellent but might be part of the preface of any man's book. These are recognized as the fundamental principles to which practically all text-books must conform and consequently a statement of them does not show in what way this book differs from any other. The author takes up the ionic theory and electrolysis in chapter xv, hydrocarbons and soaps in chapter xvii, and begins with the metals in chapter xxi. This may be admirable for anything the reviewer knows to the contrary, but it can hardly be considered as proceeding from the known to the unknown.

Wilder D. Bancroft

Ostwald's *Klassiker der exakten Wissenschaften*. No. 178. *Physikalisch-chemische Abhandlungen*. By M. Lomonossow. 60 pp. Price: 1.20 marks.—This volume contains some of the papers on physics and chemistry written by Lomonossow between 1741 and 1752. The clearness of his views on heat, on the conservation of mass, and on physical chemistry in general, is quite extraordinary because these things were not due to be discovered by the rest of the world for many years. As everybody knows, Lomonossow has had absolutely no influence on the actual development of chemical science. While part of this may be due to his having lived in Russia, that will not account for everything because Lomonossow studied in Germany and kept up a correspondence with Euler. The moral really is that it does not pay to be too clever. If a man goes in the same direction as the multitude and keeps only a little ahead of them, he is sure to be hailed as a leader and sometimes he really is one. If he gets too far ahead, he does not count at all. This was Lomonossow's fate and it was the fate of Jean Rey. It would have been Mayer's fate except for the fortunate fact that he was not very far ahead of the true leader, Helmholtz. The selection of Lomonossow as the subject of Alexander Smith's presidential address before the American Chemical Society has helped in bringing Lomonossow's work before the public.

Wilder D. Bancroft

*Denkschrift über die Gründung eines internationalen Institutes für Chemie*. By Wilhelm Ostwald. 16 × 23 cm; 30 pp. Leipzig: Akademische Verlagsgesellschaft m. b. H. 1912.—Ostwald pleads for the foundation of an International Chemical Institute which shall be a clearing-house rather than a research laboratory. It should have a library containing every book on chemistry which has ever been published. It should keep a card catalogue in which one could find all the literature references to any given substance. It should maintain a card catalogue of the publications of every chemist, living or dead. It should keep an up-to-date directory of all [living] chemists. All abstracting and re-



viewing should be done by the staff of the Institute. The files of the Institute would be of invaluable assistance to the writers of text-books. The Institute should maintain a museum containing all known chemical substances and these should be available to people wishing to determine physical constants. It should also be the duty of the Institute to perfect and introduce an international language.

This is a noble programme and parts of it are feasible, though some of us may have doubts about the international language. Ostwald is quite right in saying that it is a great waste of time and money to have the same article abstracted five or more times, but founding an International Institute will not necessarily do away with this. The English-speaking chemical societies have not yet been able to combine their abstracting even though there is no complication due to language. Co-operation with Germany or France on such a point seems even more hopeless.

*Wilder D. Bancroft*

**Famous Chemists.** By E. Roberts, B.Sc. 12 × 19 cm; 243 pp. New York: The Macmillan Company, 1911. Price: \$0.80 net.—The author gives short biographical sketches of Stahl, Boyle, Black, Cavendish, Priestley, Scheele, Lavoisier, Berthollet, Dalton, Davy, Gay-Lussac, Berzelius, Faraday, Dumas, Wöhler, Liebig, Graham, Bunsen, Hofmann, Pasteur, Williamson, Frankland, Kekulé, Mendeléeff, Perkin and Victor Meyer. An average of about nine small pages to a man is a hopeless task for anybody. As might be expected, the longer biographies are the best. The shorter ones have no apparent value unless they are intended for students reading up for an examination. *Wilder D. Bancroft*

**Fortschritte in der Gerbereichemie.** By Franz Ch. Neuner. 23 × 15 cm; 60 pp. Dresden: Theodor Steinkopf, 1911. Price: 1.80 marks.—This little pamphlet gives an account of the progress in the leather industry from 1908 to 1910. Of special interest are the theories of tanning, which are gradually assuming definite form. Almost everybody now admits that the first step in tanning is an adsorption process, but some people still hold out for a subsequent chemical reaction. The simplest hypothesis is that we have a change taking place which is analogous to the change in zinc hydroxide, hydrated ferric oxide, nickel sulphide; whereby these substances become less readily soluble in acids.

*Wilder D. Bancroft*

## THE PHYSICAL AND CHEMICAL PROPERTIES OF SOME ORGANIC AMALGAMS

BY HERBERT N. MCCOY AND FRANKLIN L. WEST

Although ammonium amalgam was first prepared a little over a century ago,<sup>1</sup> it remained until very recently the sole representative of its class. Shortly after its discovery, Davy<sup>2</sup> concluded that this unique substance was a compound of the pseudometal ammonium with mercury and while this view was shared by many chemists, others believed the so-called amalgam was only mercury inflated with ammonia and hydrogen. The true metallic nature of the substance was finally proved beyond question by the researches of LeBlanc,<sup>3</sup> Coehn<sup>4</sup> and G. M. Smith.<sup>5</sup> The experiments of LeBlanc also indicated very forcibly the possibility of the existence of substituted ammonium amalgams; and though LeBlanc concluded he had firmly established this point yet the supposed new amalgams had so transient an existence under the conditions of his experiments that they were not isolated and no evidence of their existence, other than that based on polarization potentials, was obtained.

The preparation of two new synthetic amalgams has recently been described.<sup>6</sup> These new substances are monomethylammonium amalgam and tetramethylammonium amalgam. The first of these is much like ammonium amalgam in its physical and chemical properties. The second differs markedly in several important particulars. As obtained by McCoy and Moore, it appeared as a crystalline mass mixed always with an excess of liquid mercury. It was of characteristic metallic lustre. At a temperature of zero degrees or lower it was fairly stable in the absence of

<sup>1</sup> Seebeck: *Ann. Chim. Phys.*, 66, 191 (1808).

<sup>2</sup> *Phil. Trans.*, 100, 37 (1810).

<sup>3</sup> *Zeit. phys. Chem.*, 5, 467 (1890).

<sup>4</sup> *Zeit. anorg. Chem.*, 25, 430 (1900); *Zeit. Elektrochemie*, 12, 609 (1906).

<sup>5</sup> *Jour. Am. Chem. Soc.*, 29, 844 (1907).

<sup>6</sup> McCoy and Moore: *Jour. Am. Chem. Soc.*, 33, 273 (1911).

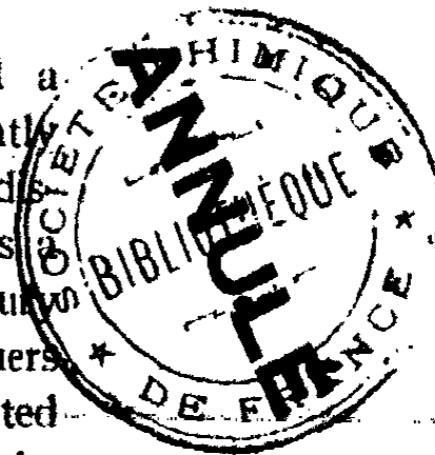

moisture. Chemically it resembles the alkali amalgams, but is far more active than that of sodium. It reacts with water with great energy and rapidly gives hydrogen and the corresponding base, tetramethylammonium hydroxide. From solutions of salts of copper and zinc, these metals are precipitated at once; while from solutions of salts of sodium and potassium the corresponding amalgams are formed. With a solution of ammonium chloride, the characteristic inflated mass of ammonium amalgam is produced. The very high solution tension indicated by these reactions was confirmed by direct potential measurements. The value obtained, for similar conditions was about 0.6 volt higher than that found recently by Lewis and Kraus<sup>1</sup> for sodium amalgam. The properties of the new synthetic amalgams presented so many novel and interesting features that the study of the subject has been continued by us with the results herewith presented.

The first object of the research was to find an improved method of preparation and preservation of tetramethylammonium amalgam which was at the same time the more interesting of the two new bodies and the more difficult to prepare. The method of McCoy and Moore consisted in the electrolysis of an absolute ethyl alcohol solution of tetramethylammonium chloride using a mercury cathode and a silver plated platinum gauze anode. The silver united with, and so prevented secondary actions by, the liberated chlorine. The electrolysis was usually made at zero C or at about  $-10^{\circ}$  to  $-15^{\circ}$ . It was found that absolute alcohol reacted with the amalgam rather rapidly even at zero, about 5 percent being destroyed per minute.<sup>2</sup> As this action during electrolysis decreased the yield very greatly, we designed a vessel (Fig. 1) in which the electrolysis could be conducted at the temperature of boiling liquid ammonia,  $-34^{\circ}$ . At this temperature, the action of the alcohol on the amalgam was much slower than at  $0^{\circ}$ C. We also found that a platinum anode

<sup>1</sup> Jour. Am. Chem. Soc., 32, 1459 (1910).

<sup>2</sup> McCoy and Moore: Loc. cit.

could be substituted for the one of silver, as the chlorine set free no longer attacked the amalgam at this low temperature.

The glass vessel shown in Fig. 1 had outside dimensions of  $13.5 \times 5.5$  cm. One of the side tubes of the jacket was joined by a rubber tube to a steel cylinder containing 50 pounds of commercial liquid ammonia. This jacket could be readily filled with liquid ammonia from the steel cylinder. After the vessel had become cold and coated externally with frost, the ammonia boiled away only slowly. The second side

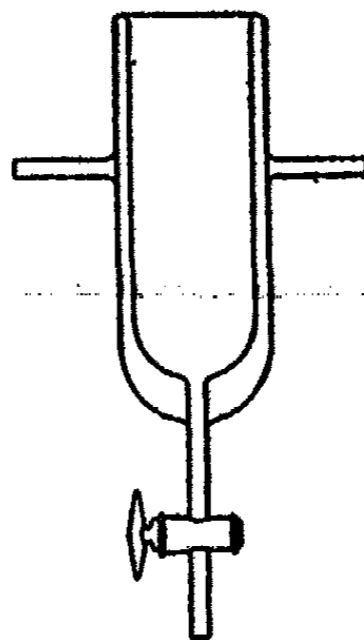

Fig. 1

tube was joined to two large bottles partly filled with water for the absorption of the waste ammonia gas. The inner chamber of the vessel was closed by a close fitting rubber stopper carrying the electrodes and a tube filled with calcium chloride. The glass tube with the stopcock leading downward from the inner chamber was intended to allow us to draw off the amalgam without exposing it to the air. However, the usual procedure with this apparatus yielded so much solid amalgam that another method of removing the product proved more expedient.

The preparation of the amalgam was carried out as follows: Seventy-five grams of clean, dry mercury were put into a piece of white muslin, 15 cm square, and lowered into the vessel (Fig. 1). Forty cc of absolute alcohol containing 1.5–2.0 grams of dissolved salt were poured in and the cloth made to stand up snugly against the damp walls of the vessel. The stopper and electrodes were adjusted and the jacket filled with liquid ammonia from the tank. The electrolysis was usually conducted with an E. M. F. of 35–40 volts, which gave a current of 0.3 ampere. After the electrolysis the cloth together with the semi-solid amalgam was then raised above the solution and the alcohol drained off while the whole was still in the electrolysis chamber, the low temperature

of which prevented decomposition of the amalgam. The latter, while still held in the cloth, was rinsed in ice-cold carbon tetrachloride. This liquid has no action on the amalgam and proved very effective in removing the alcohol and preventing decomposition by the moisture of the air. If kept at zero degrees under carbon tetrachloride, the amalgam undergoes but little change in the course of several hours.

As thus obtained, tetramethylammonium amalgam is a semi-solid mass of crystals and excess of liquid mercury, the former being but slightly soluble in the latter. By filtration, with suction, through a plug of cotton, the crystals are easily freed from most of the excess of mercury and the amalgam is left as a solid, crystalline, metallic mass, weighing about 15 grams. During filtration the temperature must be kept at or below  $10^{\circ}$  and the amalgam protected from the air by a layer of carbon tetrachloride. Unless otherwise stated all experiments in the following pages were made with *solid* amalgam which had been freed from excess of uncombined mercury.

Even at  $-34^{\circ}$ , the use of absolute alcohol as a solvent during electrolysis was not wholly satisfactory. By reason of the action of the alcohol on the amalgam, the yield of the latter was only about 15 percent of that corresponding to the quantity of electricity passed through the cell. In the hope of finding a solvent that would give a better yield than did ethyl alcohol, fifteen other liquids were tried. Those selected were such as dissolved the salt and had high dielectric constants. Only two solvents gave appreciably better results, in some respects, than did ethyl alcohol; even these solvents had their disadvantages. Propyl alcohol acts on the amalgam more slowly than ethyl alcohol, but the solution has a lower conductivity, which necessitates the use of a smaller electrolyzing current. Acetonitril behaves much like propyl alcohol. Very good preparations could be obtained from each of these solvents but no decided advantage was to be gained by using either in place of absolute ethyl alcohol.

Almost all of the experimental work represented by this

paper was carried out in an unheated room which had three large windows on each of two opposite sides. Most of the experiments requiring exposure of the amalgam to the air were made during the winter, so that with open windows, the temperature of the room was usually between  $0^{\circ}$  and  $10^{\circ}$  C.

*Physical Properties.*—The amalgam is a silver-white, granular solid. In its preparation, when the anode has been allowed to touch the cloth, large crystals will usually be found adhering tightly to the outside of the latter. These crystals will stand considerable pressure without breaking and in cold dry winter weather, their crystalline form is maintained for several minutes even though exposed to the air.

*Density.*—McCoy and Moore had observed that the solid amalgam floats on the excess of mercury and stated that the density of the amalgam is somewhat less than that of mercury. We made determinations at zero degrees of the density of several solid preparations of tetramethylammonium amalgam by the pycnometer method, using carbon tetrachloride as the accessory liquid. The weight of the amalgam alone was in some cases found by direct weighing, with the material exposed to the air, when the weather was very cold and the air dry. An alternative method consisted in weighing a beaker containing amalgam covered with carbon tetrachloride, transferring the amalgam to the pycnometer and finding the weight of amalgam removed by difference. The weight of the bottle filled jointly with amalgam and carbon tetrachloride and again when filled with the latter alone, gave, together with a knowledge of the density of the carbon tetrachloride, the required data.

After each determination, the amalgam was immediately put into water and the weight of the colloidal mercury, thus obtained, divided by the weight of the mercury, was taken as a measure of the concentration of the amalgam present.<sup>1</sup> The following results were obtained:

<sup>1</sup> See McCoy and Moore, *Loc. cit.*

Percent colloidal mercury	Density at 0° C
0.0	13.6 (pure mercury)
1.2	11.8
1.0	11.7
1.0	11.6
2.0	11.1
2.4	10.6

*Electrical Resistance.*—The electrical resistance was measured by the Wheatstone bridge principle. Three resistance boxes were connected, as in the Post Office box bridge, by means of entirely negligible leads and the lack of balance was detected with a sensitive D'Arsonval galvanometer. Even though the resistance measured was very small, yet with the ratio of 1,000-1 in two of the boxes, the galvanometer was sufficiently sensitive to give an accuracy of one-fifth of 1 percent.

The solid, but somewhat plastic amalgam was put into a funnel that was connected to a narrow U-shaped glass tube and was drawn into the latter by means of a water aspirator. The tube was 37.7 cm long and 0.047 sq. cm in cross section. The entire manipulation was, in each experiment, carried out in a very cold room; during the electrical measurement the temperature of the amalgam was kept at 0° C. The resistance of the wires connecting the amalgam to the boxes was also measured with the ends of the wires placed near together in mercury and this resistance subtracted from the total. The concentration of the amalgam was determined as above from the weight of the colloidal mercury produced when it was added to water. The following results were obtained, the specific resistance being expressed in ohms per linear centimeter and one square centimeter cross section.

Percent colloidal mercury	Specific resistance
0.0	0.000094 (pure mercury)
2.0	0.000110
2.8	0.000110
5.0	0.000131
—	0.000133
—	0.000139

The percent of colloidal mercury was not determined in the last two samples. The leads dipped a short distance below the surface of the amalgam and it was therefore difficult to get at the true length of the column of material. This, together with the difficulty of working with the material, would not make the results given accurate to more than 1 or 2 percent. It is to be observed that the higher the amalgam content, the greater is the resistance, and that the most concentrated amalgam has a resistance about one and one-half times that of mercury.

*Electrical Behavior of the Amalgams.*—Coehn<sup>1</sup> discovered that ammonium amalgam discharged a charged electroscope, but that the discharge takes place only if the electroscope is charged electro-negatively. We had no difficulty in confirming Coehn's observations on the discharge of negative electricity, and in addition, contrary to Coehn, we found that a small though decisive effect was always produced when the leaf of the electroscope was positively charged. We have also found that organic amalgams have similar properties. Monomethylammonium amalgam discharges both positive and negative electricity, the effect being, as in the case of ammonium amalgam, several times greater with negative electricity. On the other hand, tetramethylammonium amalgam discharges rapidly the positively charged electroscope but has no effect when the electroscope is negatively charged.

The electrical behavior of the last named amalgam is suggestive of that of the alkali metals and their amalgams. It is a well-known fact that many metals give off electrons under the influence of ultraviolet light.<sup>2</sup> This action is the more pronounced the greater the electropositive nature of the metal. It is small with mercury, but is very marked with sodium and potassium. In case of the alkali metals, a strong source of ultraviolet light is unnecessary, even the light of a kerosene lamp is sufficient, while rubidium is still more sensi-

<sup>1</sup> Zeit. Elektrochemie, 12, 609 (1906).

<sup>2</sup> Thomson: "Conduction of Electricity through Gases," Chap. X.



tive and gives off negative electricity in the presence of a red hot glass rod. As the electrolytic solution tension of tetramethyl ammonium amalgam is about 0.6 volt greater than that of sodium amalgam and about equal to that of potassium amalgam,<sup>1</sup> we might expect, therefore, that the organic amalgam would lose electrons under similar conditions. An account of our study of the electrical behavior of synthetic amalgams is given in the following pages.

The electroscope used was like that described by McCoy and Ashman,<sup>2</sup> excepting that there was no condenser, C, nor plate L, to increase the electrostatic capacity. The instrument was one that had been used for several years in this laboratory for the quantitative measurement of radioactivity. The ionization chamber is 20 cm square and 14 cm high; the gold leaf chamber, 9 cm square and 10 cm high. The gold leaf system is insulated by an amber plug and carries at its lower end a circular brass plate or electrode 8 cm in diameter. The motion of the leaf is observed through a pair of glass windows by means of a micrometer microscope. With the aid of two switches and a battery of small dry cells, the leaf could be instantly grounded or charged positively or negatively to about 300 volts. The discharge of the electroscope by an amalgam is most readily distinguishable from that by a radioactive substance in two noticeable particulars: (1) the rate of discharge by the amalgam is erratically variable, (2) it also depends on the sign of the electric charge on the gold leaf system. However, the rate of discharge by an amalgam, though irregular, may be observed and measured in precisely the same way as in the case of a radioactive substance. This rate of discharge may readily be expressed in term of that produced by a standard film of uranium oxide. Such a film, which produced an ionization current of  $2.15 \times 10^{-11}$  amperes as shown by comparison with one of McCoy and Ashman's standards,<sup>3</sup> was used

<sup>1</sup> McCoy and Moore: *Jour. Am. Chem. Soc.*, **33**, 289 (1911).

<sup>2</sup> *Am. Jour. Sci.*, **26**, 521 (1908).

<sup>3</sup> McCoy and Ashman: *Loc. cit.*

throughout this work and will be referred to as the "standard." In measuring the rate of discharge, the uranium film or the amalgam held in a shallow platinum dish was placed under the electrode on an earthed metallic support the distance of which below the electrode could be varied up to 8 cm. The micrometer scale of the reading microscope had 60 divisions; the standard discharged the electroscope at the constant rate of 42 divisions per minute. The natural leak amounted to about one-half division per minute.

The behavior of ammonium amalgam may be first considered. We made this amalgam by the electrolysis of an ice-cold aqueous solution of ammonium sulphate. In one experiment 80 grams of mercury were used and a current of 0.3 ampere was run for 10 minutes. When the amalgam was placed in the electroscope and the gold leaf system charged negatively, the rate of discharge was so great that it could not be measured with much accuracy, but was approximately equal to 6 times the uranium standard. After several repetitions of this measurement with concordant results, the gold leaf system was charged positively; the rate of discharge was now much slower but still many times as fast as the minimum that could have been detected with certainty. The rate for the positive discharge was 0.26 that of the standard. At other times three other samples of ammonium amalgam were prepared and studied in the manner just described. The results were in all cases much like those recorded: a small rate of discharge of the positively electrified leaf and a 20-50-fold greater rate for one negatively charged.

The rate of discharge of the electroscope by tetramethylammonium amalgam was studied in a large number of experiments. The detail of a few of these will fully illustrate the nature of the results observed. (1) A sample of the amalgam made in the manner already described and filtered from the excess of mercury was placed in the electroscope on a large platinum crucible lid. The positively charged gold leaf system was repeatedly discharged at a rapid rate. The motion of the gold leaf was very irregular and often

jerky, in notable distinction to the behavior when the discharge is caused by a radioactive substance. Five consecutive determinations of the rate of discharge in terms of that of the uranium standard as unity gave the following figures: 0.6, 1.6, 1.7, 2.9, 2.9, the charge on the gold leaf in all cases being positive. Immediately after the last of the above measurements, the gold leaf system was charged negatively: no discharge took place, although one one-hundredth of the rate shown in the last measurement with a positively charged system could not have escaped notice. After several minutes the sample still discharged a positive charge as fast as the uranium standard. This experiment was made on December 21st and therefore during cold weather, with the room unheated. Although the electroscope used was capable of giving activity measurements accurately to a small fraction of 1 percent, of the standard<sup>1</sup> the erratic variability of the rate of discharge by tetramethylammonium amalgam made it useless to express the results with greater apparent accuracy than they are here recorded. The enormous variation from one determination to another is therefore a real one and is not due to any appreciable inaccuracy of the method of measurement. This was further shown by the fact that substitution of the uranium film for the amalgam led, as is always found, to entirely concordant constant readings for the rate of discharge.

(2) On February 20, 1911, a very good preparation of tetramethylammonium amalgam was made by a current of 0.32 ampere for 1.5 hours. At a room temperature of almost exactly zero the following rates of discharge of the positively charged electroscope were observed: 0.30, 0.16, 0.38, 0.06, 0.19, all in terms of the uranium standard as unity. The gold leaf system was then charged negatively, but no discharge occurred. With a positive charge the following additional rates were observed: 0.41, 0.10, 0.25. The last rate in each of the two series with this sample is much greater than the one immediately preceding it. In each case the

<sup>1</sup> See McCoy and Ashmann: *Loc. cit.*

sample was stirred immediately before the reading was taken. A similar effect was often noticed.

(3) On March 1, 1911, a sample was made by a current of 0.4 ampere for 1 hour. This was filtered and placed in the electroscope. At a room temperature of 6° the following rates of discharge were observed in the six successive determinations made in the course of 4 or 5 minutes: 1.6, 7.0, 1.7, 3.3, 1.4, 0.38.

(4) On May 4, 1911, a current of 0.3 ampere for 2 hours and 5 minutes gave a large yield of amalgam of excellent quality. The filtered product placed in the electroscope at a room temperature of 12° caused discharge of the positively charged gold leaf system at a very great rate, too fast to be measured. No effect was produced when the charge was negative. The large portion of this sample was covered with carbon tetrachloride and kept on ice until later in the day. The balance was used to find the effect on the rate of discharge of the distance between the amalgam and the electrode of the gold leaf system. The charge was positive in all cases. The successive rates of discharge were as follows: Far, 1.8, 0.9; near, 1.8, 0.50; far, 0.14; near, 0.40, 0.14; far, 0.08; near, 0.12. The distances designated as far and near were 3.7 cm and 1.5 cm, respectively. In spite of the fact that the rate was decreasing rapidly, it is easy to see that the effect is greater when the amalgam is near the electrode. The significance of this is discussed later. The portion of the sample kept on ice under carbon tetrachloride was tested after the lapse of about an hour; immediately upon being placed in the electroscope, the rate of discharge was enormous: as close an estimate as could be made indicated an activity 25-30 times that of the uranium standard. This very great activity continued for about 5 minutes. The temperature of the room was 12° at the time.

These experiments show conclusively that tetramethylammonium amalgam causes a discharge of positive electricity only. The rate of discharge is irregular for a given preparation under constant conditions and varies from one

preparation to another. Temperature has an enormous effect on the activity of the amalgam. Thus in experiments 2, 3, and 4, the room temperatures were 0, 6, and 12 respectively and the maximum rates of discharge 0.38, 7.0 and 30 times the standard.

A large crystal that had been found adhering to the outside of the cloth on a cold, dry, winter day was placed in the electroscope. It showed no signs of decomposition for several minutes and it also had no effect on the charged leaf. It then slowly began to show evidence of decomposition and also began to have a slight effect on the leaf which increased to about 0.1 the rate of the standard and continued thus for several hours. This seems to indicate that the phenomenon is not an intrinsic property of the crystalline amalgam but is concomitant with its decomposition. On the other hand it was frequently found that after the electrical activity had entirely ceased, the residue would give colloidal mercury with water, showing that decomposition was not yet complete.

With a positive charge on the leaf, the amalgam discharges the electroscope very similarly to a true radioactive substance. There is not the slightest doubt, however, that the phenomenon is not one of radioactivity. A radioactive substance discharges both positive and negative charges at the same rate; moreover this rate is not erratically variable and is not affected by temperature. An additional fact also differentiates the phenomenon from that due to radioactive ionization: for the production of the maximum ionization current, a given radioactive substance must be at least a certain distance from the electrode. This minimum distance is the range<sup>1</sup> of the alpha rays of the substance. If the radioactive film is much nearer the electrode than the distance represented by the range of its alpha rays, its rate of discharge is much less than the maximum. For moderate distances greater than the range the ionization current is not appreciably lower than the maximum. In experiment 4

<sup>1</sup> Bragg: *Phil. Mag.*, [6] 8, 726 (1904).

above we found that the rate of discharge by the amalgam was greater at 1.5 cm than at 3.7 cm. As the ranges of the alpha rays of radioactive substances lie between 2.6 cm and 8.0 cm this is further evidence of the difference between the behavior of the amalgam and a radioactive substance.

The facts so far mentioned indicate either (1) the liberation by the amalgam of electrons with velocities too low to cause ionization of the air or (2) the production of an electro-negatively charged gas. Since the escape of electrons from a metal is enormously accelerated by the action of ultraviolet light, we next studied the behavior of the amalgam in this respect.

The effect of daylight on the rate of discharge of the electroscope by tetramethylammonium amalgam was shown by the following experiments. A large quantity of solid amalgam was placed in the electroscope and the door of the ionization chamber left open and directed toward the window of the room. The rates of discharge were 0.30 and 1.7 times the standard. The brass door of the ionizing chamber was then closed, thus leaving the amalgam in total darkness, and the following rates of discharge observed: 1.6, 2.9 and 1.1. The experiment shows that the phenomenon occurs in the dark as well as in the light. In fact many of the results already recorded were obtained when the amalgam was in complete darkness. In several experiments, magnesium ribbon was burned close to the open door of the ionization chamber and the light, rich in ultraviolet rays, allowed to fall upon the amalgam; but no acceleration of the rate of discharge was produced.

A more elaborate study of the effect of ultraviolet light on the behavior of tetramethylammonium amalgam was greatly facilitated through the generous coöperation of Dr. J. R. Wright, of Ryerson Physical Laboratory of this University. At the time we were engaged in this research, Dr. Wright, working with Professor Millikan, was investigating the effect of ultraviolet light upon aluminium. Dr. Wright's paper on the results has just appeared in the

*Physikalische Zeitschrift*, 12, 338 (1911) under the title: "The Positive Potential of Aluminium as a Function of the Wave Length of the Incident Light." For his own work Dr. Wright had a very powerful source of ultraviolet light produced by the spark discharge between zinc electrodes in parallel with eight Leyden jars and operated by the secondary current of a Seidel transformer, through the primary of which a current of 10 amperes at 25 volts was passed. Dr. Wright's installation also included a Dolezalek quadrant electrometer with the wires leading to it surrounded by earthed brass tubes. As this apparatus was admirably suited for the purpose of testing the effect of ultraviolet light on our amalgam we were very glad to have the privilege of its use in making the following experiments. For his courtesy in this respect and for his valued cooperation in the experiments we wish to express to Dr. Wright our sincere thanks.

The immediate object of our experiments was to find the nature and potential of the charge which the amalgam when insulated and in contact with very cold, dry air might acquire under the influence of ultraviolet light. From the electro-scope experiments, we should expect such a charge to be electropositive. This also would be in accord with the behavior of the alkali metals.<sup>1</sup> The insulated amalgam was connected to the quadrant electrometer by a wire which passed with sulphur insulation through a brass tube 6 cm in diameter. The terminal of this wire together with the amalgam and its support were shielded from the spark by means of large sheet metal screens. One of these screens had an opening  $2 \times 4$  cm which was covered by a piece of cardboard having an opening 2 mm square. The light from the spark passed through this opening and illuminated the amalgam. The needle of the electrometer was charged to 120 volts and held its charge perfectly for hours. One pair of quadrants of the electrometer was earthed; a charge of

<sup>1</sup> Thomson: *Loc. cit.*

1 volt on the other pair gave a scale deflection of 3.4 cm. When the amalgam was absent and the spark going, the agitation of the needle due to static effects was not over 1 mm on the scale. In the preliminary experiments the amalgam rested on a watch glass supported by a vulcanized rubber stand.

Before making an experiment, all four quadrants of the electrometer were earthed; when all was ready, the earth connection of one pair of quadrants was lifted and this pair connected to the amalgam, appropriate switches being used. In all cases the amalgam took on a positive charge; a maximum potential of about 2.4 volts was usually reached in a few minutes. There was some doubt, however, whether the result was due to the ultraviolet light. It seemed possible that the amalgam might have acquired a positive charge spontaneously in the absence of the light.

In the final experiments the amalgam was contained in the glass tube represented by Fig. 2. This tube was 9 by 1.3 cm and had a small side tube closed with a quartz glass window. The spark passed through the 2 mm opening in the screen and through the quartz window and illuminated the amalgam. During an experiment, the lower part of the tube holding the amalgam was surrounded by ice and water.

The first trial with the amalgam in the tube Fig. 2 was begun before the spark was started. During the first 3 minutes, the positive potential of the amalgam rose slowly to 0.2 volt; the spark was now started and allowed to illuminate the amalgam. It seemed to have no effect on the rate of increase of potential. It was soon turned off without noticeable effect, for the amalgam continued to increase in positive potential until the electrometer deflection indicated 2.7 volts. In three subsequent trials in which the spark giving the ultraviolet light was not running, the amalgam took on potentials of 2.7, 2.8, and 3.8 volts respectively. The maxima were usually reached in 5-10 minutes. The



Fig. 2



charge on the amalgam was positive in all cases. These results made it clear that the taking on of a positive charge by an insulated portion of tetramethylammonium amalgam is a spontaneous action which is not caused by the illumination with ultraviolet light. However, it is still possible that the ultraviolet light may be able to cause a smaller additional effect, which in our experiments in which the light also acted was masked by the larger spontaneous one.

The acquirement of a positive charge by the insulated amalgam can only mean that it loses spontaneously negative electricity. This fact is in complete accord with that of the discharge of the positively charged electroscope in the presence of the amalgam. The carriers of the negative electricity given off by the amalgam may be either (1) electrons or (2) ions, consisting of electronegatively charged molecules or larger groups or in general terms an electronegatively charged gas.

*Photographic Experiments.*—The difference between the activity of tetramethylammonium amalgam and that of the typical radioactive element uranium was clearly shown by the behavior of each toward photographic plates. For the experiments, Lumière Sigma dry plates were used. (This make is known to be rapid.) These were exposed with all usual and necessary precautions for known periods to the action of the rays from a quantity of uranium oxide which discharged the electroscope about as fast as the average sample of the amalgam. A plate exposed to the uranium oxide for 15 minutes showed distinctly a uniform black spot of the same size as the 3 cm hole in the piece of sheet iron which shielded the balance of the plate from the action of the alpha and beta rays of the uranium. Longer exposures gave blacker spots. One of the same kind of plates was also exposed, under strict photographic conditions, to the action of the amalgam in place of the uranium, all else being the same. Seven preparations of solid (filtered) amalgam were allowed to act on the plate successively in the course of 12 days. The total weight of the solid amalgam so used was 115 grams;

its preparation had required a total of 4.85 ampere hours. Upon development, this plate was found to be "fogged" in the centre, the intensity being about equal to that caused by 30 minutes' exposure to the uranium. The "fogged" portion of the plate was not sharply defined, corresponding to the hole in the sheet iron, as in the case of exposure to uranium rays. This fact suggested some other cause than the action of a radiation from the amalgam: possibly the dim red light used in the dark room or the action of mercury vapor during the long exposure. The first possibility was excluded by the fact that plates exposed to the red light for much longer periods than the total possible exposure to the same source in the amalgam experiment showed no effect at all upon development. On the other hand, a plate exposed for 13 days to the action of pure mercury under the same conditions as used in the case of the amalgam showed a distinct circular spot, fully as dark, if not darker, than that on the plate which had been exposed to amalgam. These experiments show clearly that the apparent photographic action of the amalgam was due simply to mercury vapor and that the amalgam has no photographic activity.

The experiments on the electrical behavior of the amalgam and the fact that this was not influenced by ultraviolet light, together with the negative results of the photographic experiments, are all best explained by the assumption that the amalgam gives rise to an electronegatively charged gas. In the electroscope, the electronegative ions are attracted to the positively charged electrode and so discharge the gold-leaf system. On the other hand, the negative charge of the ions comes from the amalgam; so that, if the latter is insulated, as in the quadrant electrometer experiments, it acquires a positive potential. The cause of the electrification of the air or gas is not certain although the following explanation seems probable. It is shown (in the following section) that the spontaneous decomposition of the dry amalgam gives, besides mercury, trimethylamine and hydrocarbon gases, from 40-60 cc resulting from a single prepara-

tion. Now Lenard<sup>1</sup> has found that air bubbled through or shaken with mercury becomes negatively electrified. From this, it would seem very probable that the gases formed by the decomposition of the amalgam would escape from the interior of the mass in an electrified condition. It might seem that this explanation would require that the gas from every amalgam should have the same kind of electrification, whereas this is not the case. However, it is not improbable that mercury may behave like water which electrifies gases bubbled through it either negatively or positively according to the nature of the solution and the gas.<sup>2</sup> The fact already mentioned that the amalgam does not lose electricity except when it is decomposing is further evidence in favor of this view. Also the fact mentioned in an earlier paragraph that the rate of discharge of the electroscope by the amalgam is greater when the latter is near the electrode is entirely in accord with the view that a charged gas is given out by the amalgam, since, under such conditions, fewer of the gaseous ions will fail to reach the electrode. The effect would be very different if a radiation capable of causing ionization were given out by the amalgam. Further evidence in this direction is also furnished by the following experiment.

A very good preparation of the amalgam that had been obtained with a current of 0.5 ampere for an hour and a half was freed from excess of mercury and put in a small crystallizing dish,  $3\frac{3}{4}$  cm in diameter and  $1\frac{1}{4}$  cm high, and placed in the electroscope with the gold leaf system charged positively. The discharge rate was 0.63 of the standard. A piece of aluminum leaf 0.0044 cm thick was now quickly sealed with wax over the mouth of the dish. The covered amalgam had no effect whatever on the positively charged gold leaf system. The aluminum leaf was now removed and the amalgam again placed in the electroscope. The discharge rate was 0.19 of the standard. A second trial with the

<sup>1</sup> Wied. Ann., 46, 584 (1892).

<sup>2</sup> Kelvin: Proc. Roy. Soc., 57, 335 (1894). Kusters: Wied. Ann., 69, 12 (1899).

aluminum leaf over the amalgam resulted like the first, and when the leaf was again removed the discharge rate was 0.33 of the standard. This experiment was repeated on several different occasions with other preparations of amalgam with exactly similar results. It is thus seen that the charged particles that arise from the amalgam can not pass through aluminum leaf of the thickness used. On the other hand, this aluminum leaf would absorb only a small fraction of a beta radiation such as that of uranium, but would completely prevent the passage of gaseous ions of all sorts.

The carriers of electricity or the ions of a gas electrified by bubbling have much smaller velocities in an electric field and much smaller speeds of diffusion than have ions produced by radioactive radiations. The former sort of ions are therefore much more persistent than the latter so that the gas remains charged for a relatively long time. It also retains much of its charge after passing through glass-wool, etc. The following experiments show that the negative electrification of the gas from tetramethylammonium amalgam is present as persistent ions. The rate of discharge of the electroscope by a sample of amalgam contained in a porcelain boat was determined in the usual way. The boat and amalgam were then brought into a straight "calcium chloride tube" outside of the electroscope and a current of air blown over the amalgam and into the electroscope, the air emerging near and toward the electrode, and the rate of discharge again noted. As a mean of four such independent experiments, it was found that the rate of discharge was 95 percent as great in the second case as in the first. In a similar experiment in which uranium oxide was substituted for the amalgam, the rate of discharge by the air current was only 28 percent of that when the uranium was in the ionization chamber. It was also found, in several trials, that an appreciable part of the electrification of air blown over the amalgam would pass through a 6 cm layer of glass wool or a narrow copper tube 30 cm long and 0.2 cm in diameter, while

if the path of the air current included both of these the electrification was all removed.

In beta ray radioactive changes, at least one electron is liberated by the disintegration of each atom. It is easy to calculate roughly how much electricity is contained in the electrified gas produced during the decomposition of the amalgam and to compare this quantity with that if each molecule of the amalgam decomposed gave off one electron. A quantity of amalgam, the decomposition of which would yield 50 cc of gas of which 29 cc would be trimethylamine, would on the average discharge the positively charged electro-scope at a rate equal to that of the standard for a period of about 10 minutes. Since the standard produces an ionization current of  $2.15 \times 10^{-11}$  amperes and 1 cc of a univalent gas would represent 4 coulombs, it follows that only one electron is given off for every  $10^{10}$  molecules of amine gas formed! This fact is itself sufficient to show that this phenomenon has nothing in common with that due to a radioactive transformation. If a few drops of water be added to the amalgam while it is in the electro-scope, with the gold leaf system positively charged, the discharge becomes very rapid for about 1 minute and then suddenly stops. The duration of the rapid discharge depends on the quantity of amalgam present and it is a particularly significant fact that the rate of electrical discharge is evidently dependent on the rate of decomposition of the amalgam.

The action of water on tetramethylammonium amalgam gives hydrogen and tetramethylammonium hydroxide.<sup>1</sup> In the absence of water the amalgam decomposes spontaneously giving a mixture of gases having the intense fishy odor, characteristic of trimethylamine. The speed of decomposition varies greatly with the temperature. At zero it is very slow; at 25° it is much faster, the decomposition being practically complete in about an hour. A quantitative velocity determination was made by the use of a Lunge gas burette fitted with a water jacket through which water at the

<sup>1</sup> McCoy and Moore: *Loc. cit.*

constant temperature of 27° flowed. A quantity of the amalgam, made and washed as usual but not filtered, was freed from carbon tetrachloride as thoroughly as possible by means of filter paper and brought into the burette. Before introducing the amalgam, the burette and leveling tube were carefully dried and filled with dried mercury. As time went on, the amalgam began to decompose and the gas to accumulate in the burette over the amalgam; its volume at atmospheric pressure was read off at frequent intervals with results as shown in the following table:

VELOCITY OF DECOMPOSITION OF DRY TETRAMETHYLAMMONIUM AMALGAM AT 27°, K' AND K BEING CALCULATED BY THE MONOMOLECULAR FORMULA

Time in minutes	Volume of gas formed cc	K' $t_0 = 8$ min.	K $t_0 = 13$ min.
0	0.0	—	—
8	2.0	—	—
9	2.8	0.060	—
11.5	5.5	0.083	—
13	7.2	0.094	—
15	9.5	0.110	0.155
17	11.3	0.124	0.161
19	12.7	—	0.168
21	13.5	—	0.163
23	14.1	—	0.160
25	14.5	—	0.155
29	15.0	—	0.145
33	15.5	—	0.160
46	15.75	—	—
56	15.85	—	—
		Mean, 0.158	

During the washing and drying of the amalgam and its introduction into the burette, it was kept as cold as possible. Its temperature at the moment it was inclosed was therefore far below that of the water jacket, 27°. It must have required considerable time (perhaps 10 minutes or more) for the amalgam to have reached this higher temperature. For this reason the velocity constant, K, of the rate of decom-

position was calculated from the time 13 minutes after the start. A calculation based on the 8th minute as zero gave the values under the heading  $K'$ ,  $t_0 = 8$  minutes. The results after the 13th minute show that the reaction is monomolecular. The initial velocity is very low, owing to the low temperature of the amalgam at the start. A second disturbing factor at the start was due to the fact that the gas did not separate from the amalgam readily, due no doubt to its being present in the minute bubbles. This resulted in a swelling of the material without the appearance, for several minutes, of a gaseous layer. Two additional velocity determinations under similar conditions gave results essentially like that just discussed. In an attempted velocity determination at  $0^\circ$ , no gas had separated in the course of 4 hours, although some increase of volume of the amalgam seemed to have taken place. At the end of the 4th hour, the temperature was raised to  $25^\circ$  whereupon the decomposition occurred as usual and was complete in the course of an hour. The amalgam used in this experiment had been prepared by a current of 0.21 ampere for 1 hour and 50 minutes; the amount of mercury used was about four times the usual amount, the object being to obtain a more fluid product than usual.

The gas obtained by the spontaneous decomposition of this sample of amalgam measured 63.4 cc. It was transferred quantitatively to another burette over mercury and a known volume of 0.1 normal HCl introduced. The basic portion of the gas was absorbed by the acid solution; the volume remaining was 26.5 cc, corresponding to an absorption of 58.2 percent. In several analyses, the uncombined standard acid was titrated and a comparison made with the shrinkage in volume when the acid was added. For instance, in another experiment 40.15 cc of gas shrank to 16.1 cc when the acid was added. The shrinkage was thus 24.05 cc. The titration of the uncombined standard acid showed 9.47 cc to have been neutralized by the 24.05 cc of gas absorbed. If this gas were univalent, it should have required 9.53 cc of the standard acid. Similar measurements in other analyses gave equally

concordant results, and show that the gas absorbed is a univalent amine or a mixture of such amines.

The solutions of the amine hydrochlorides from several determinations were united, made alkaline with caustic soda and the amines distilled off and absorbed in water. The solution was neutralized with hydrochloride acid, treated with platonic chloride and alcohol and the resulting yellow precipitate washed thoroughly with absolute alcohol.<sup>1</sup> In the analysis of the substance, 0.1308 gram gave upon ignition 0.0470 gram of platinum, equal to 35.93 percent; trimethylamine chlorplatinate requires 36.94 percent. Dimethylamine and monomethylamine chlorplatينات require 39.0 and 41.32 percent of platinum, respectively. In spite of the somewhat low value found, there is little doubt that the gas is trimethylamine.

The gas insoluble in the standard acid was analyzed by means of the usual Hempel apparatus; 14.05 cc of it was exploded with 41.4 cc of pure oxygen. After the explosion 27.4 cc of gas remained. This consisted of 16.16 cc of carbon dioxide, soluble in 30 percent KOH, and 11.24 cc of oxygen soluble, excepting a minute bubble, in alkaline pyrogallol. These results indicate that the decomposition of the tetramethylammonium radical occurs as follows:

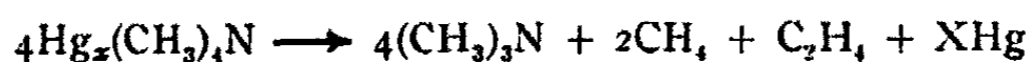

This reaction would give 57.1 percent by volume of trimethylamine while the experiment described gave 58.2 percent of soluble gas and the average for 8 additional experiments was 58.3 percent. Each cc of the amine-free gas should require 2.33 cc of oxygen and produce 1.33 cc of carbon dioxide. This particular experiment showed 2.15 cc and 1.15 cc respectively while the mean of four such determinations gave 2.21 cc and 1.20 cc, respectively. Theoretically also each cc of the amine-free gas should require an equal volume of oxygen to unite with the hydrogen of the methane and ethylene; in the experiment the oxygen consumed, in excess

<sup>1</sup> Eisenberg: Liebig's Ann., 205, 142 (1880).



of that needed for the carbon, was 1.01 cc per cc of original gas. However, a more thorough study of the decomposition products will be necessary before the reaction suggested can be considered as definitely established.

*Monomethylammonium Amalgam.*—McCoy and Moore made this amalgam by electrolysis of both aqueous and alcoholic solutions of its salts and made potential measurements with it just as with tetramethylammonium amalgam. In the attempt to increase the yield we tried a large number of additional solvents. There was amalgam formation in methyl alcohol and glycerol solutions as well as traces in some of the others. Although the current is small with the glycerol, the crystalline character of the amalgam is well marked. However, water as solvent gives the best results. The amalgam decomposes rapidly in all cases during the electrolysis giving off a gas with a strong ammoniacal odor, obviously monomethylamine. While the current is on, a dense white cloud persists in the electrolyzing chamber. Neutral liquids, such as carbon tetrachloride or benzene, exercised no protective action on the amalgam nor did low temperatures appreciably increase its stability. A fair preparation was obtained in one experiment at  $75^{\circ}$  and that made at  $-34^{\circ}$  was little if any superior to the one obtained when the temperature was kept at  $0^{\circ}$ .

Monomethylammonium amalgam increases greatly in volume as it undergoes spontaneous decomposition, in which respect it closely resembles ammonium amalgam. In each case the compact amalgam constitutes without doubt the alloy with mercury of the metallic form of the radical, while the distended material is only mercury inflated with the gaseous decomposition products. As stated in the introduction, monomethylammonium amalgam discharges the electroscope when the latter is charged either positively or negatively, the rate being several times greater for a negative charge. In several experiments a rate of discharge 3-4 times that of the uranium standard was observed for a negative charge on the gold leaf. The effect of the distance of

the amalgam from the electrode of the electroscope was tried as in the case of tetramethylammonium amalgam. In one such experiment the rate was 1.6 times the standard for a distance of 1.5 cm and 0.8 for 3.7 cm, the leaf being negatively charged.

#### Summary

(1) An improved method of making tetramethylammonium amalgam has been worked out, and the substance obtained in solid form. Determinations of its density and electrical resistance have been made.

(2) The amalgam causes the discharge of a positively charged electroscope, behaving in this respect like a radioactive substance. That the phenomenon is not one of radioactivity was shown by the following facts: a negatively charged electroscope is not discharged; the rate of discharge of a positive charge is erratically variable, temperature having an enormous effect; the rate is greater when the amalgam is closest to the electrode of the electroscope, thus showing the absence of an ionizing radiation. A thin aluminium leaf placed over the amalgam prevents the discharge and so proves the absence of a beta radiation. The same conclusion is supported by the fact that the amalgam has no photographic activity. The phenomenon is distinguished from that shown by the alkali metals in that it is not appreciably influenced by ultraviolet light. The facts here summarized as well as some others of minor importance are best explained as follows: The amalgam decomposes spontaneously into mercury and gaseous products. The gas escaping from the mercury in minute bubbles is negatively electrified, just as in the case of air bubbled through mercury as shown by Lenard. The ions of the negatively charged gas cause the discharge of the positively charged electroscope.

(3) The spontaneous decomposition of the amalgam which takes place very slowly at 0° but quite rapidly at 25° seems to occur according to the equation:

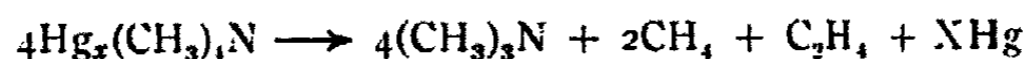

The fact that a velocity determination of the speed of decomposition showed the reaction to be monomolecular indicates that the change takes place in stages.

(4) The method of preparation and the properties of monomethyl amalgam were also studied.

(5) The further study of the properties of organic amalgams, as described in this paper, has served to support the hypothesis that free radicals, formed by the electrical neutralization of the positive ions of salts would have metallic properties.<sup>1</sup>

*Kent Chemical Laboratory,  
University of Chicago, Dec., 1911*

<sup>1</sup> McCoy and Moore: *Loc. cit.* McCoy: *Science*, 34, 138 (1911).

## A ROTATING CATHODE

BY C. W. BENNETT

In order to obtain samples of metals and alloys, by precipitation on a rotating cathode, with high current densities, for the purpose of studying their physical properties, a cathode has been designed and built, which will perform six thousand revolutions per minute, carry three hundred amperes, and operate continuously under these conditions. A sketch of the cathode, mounted with motor, rheostat, and accessories, is shown in Fig. 1. The whole apparatus was mounted

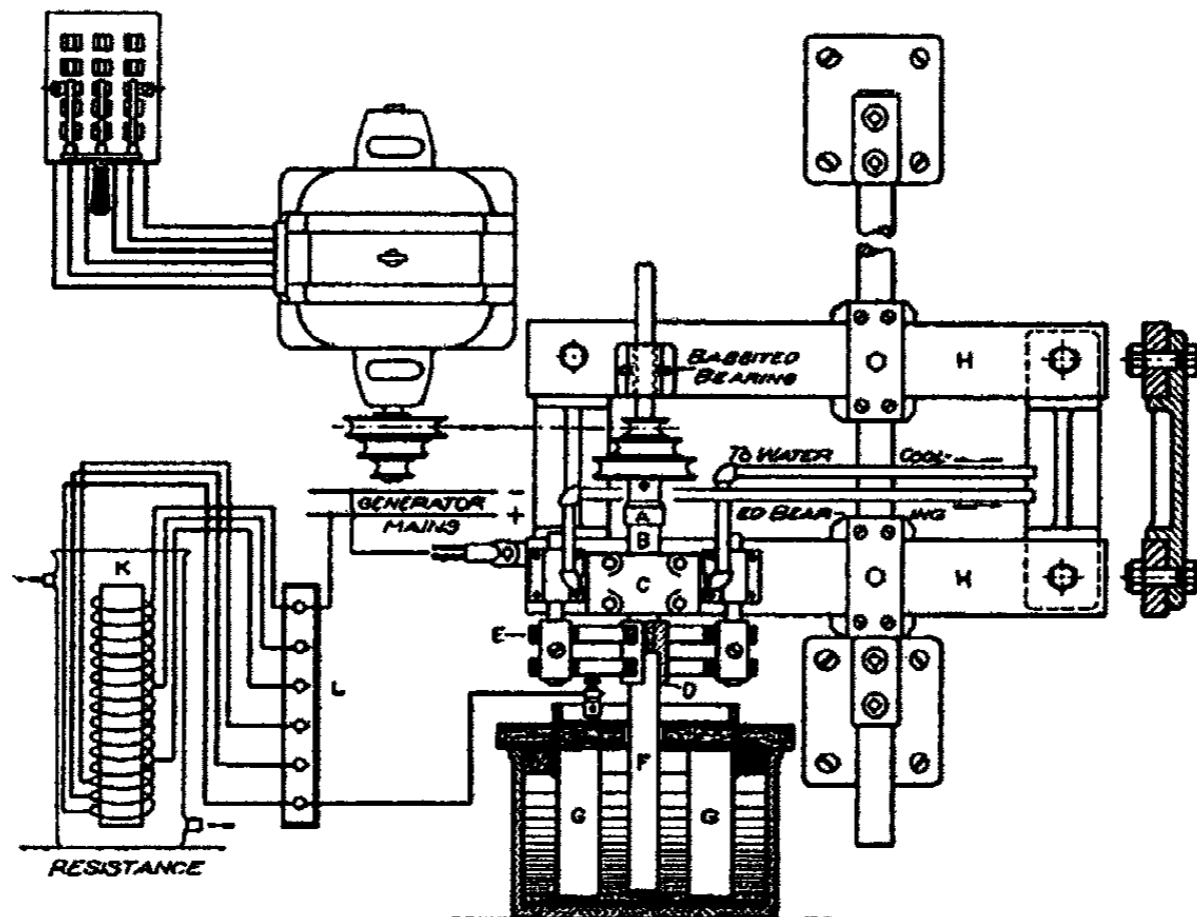

Fig. 1

on a frame of heavy boards, 2"  $\times$  8" well braced, and fastened, to prevent vibration. An inch and a half steel rod was held by set screws in the two cast steel holders which were screwed securely to the vertical face of the support. Fitting over this steel rod were two collars, held in place by heavy set screws at the back. The extensions on these collars were notched

to receive the two steel bars H, H, which were  $24" \times 4" \times \frac{1}{2}"$ . In front of these, and fastened to the collars were heavy steel plates, through which cap screws passed, clamping the bars H, H, at any desired position in the horizontal plane. In order to prevent vibration and change of adjustment, two heavy bars or stiffeners were bolted vertically between

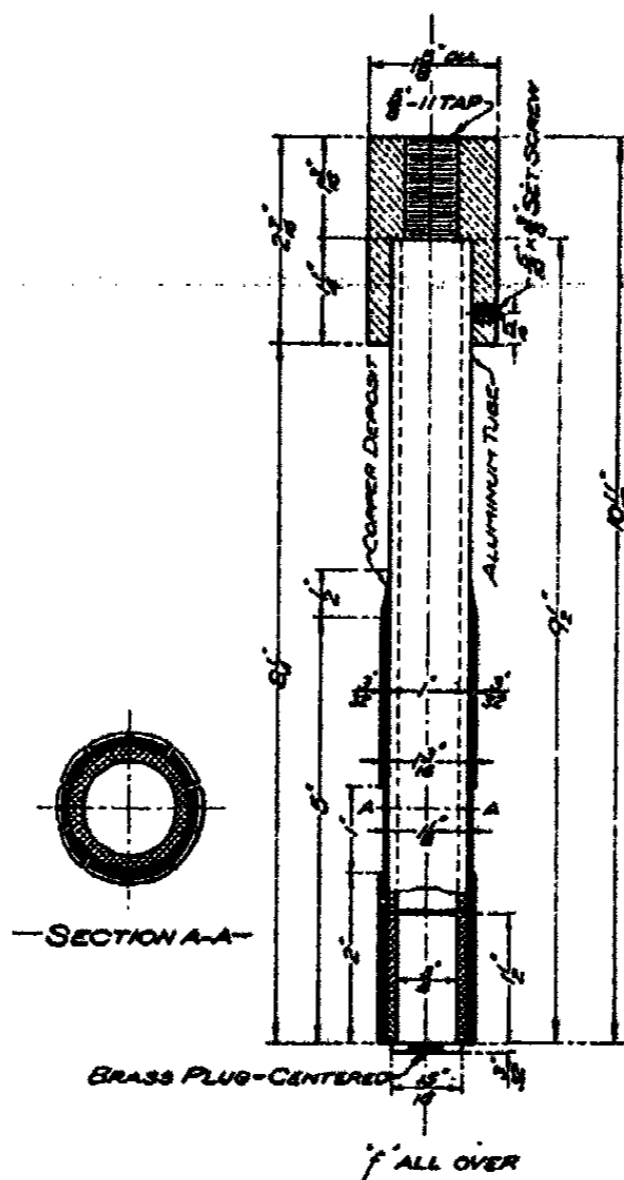

Fig. 2

the ends of the bars H, H. By means of this arrangement, it may be seen that adjustment could be obtained around in the horizontal plane, and upward and downward in the vertical plane. The cathode F consisted of a length of aluminum pipe, one inch outside and three-quarters inch inside diameter and nine or ten inches long (furnished by Mr. Blough, of the Aluminum Company of America). A rubber stopper served to close the bottom. This tube was held in

an inch hole in the brass connector D, by a set screw. The top end of the connector was tapped to receive a  $\frac{3}{8}$ " shaft. The cathode and connector are shown in detail in Fig. 2. The shaft and cathode were mounted on the steel bars H, H, by two bearings, a simple babbited one at the top, with a ball bearing A, and a roller bearing B, at the bottom. The shell of the roller bearing B, fitted into a water-cooled collar C, which being bolted to H held the bearing in place. At high speed of rotation it was found necessary to cool this bearing, hence the hollow collar was cast. A detail of the bearings, water-cooled collar, and an assembly of these are shown in Figs. 3 and 4. In using generator circuits where the positive

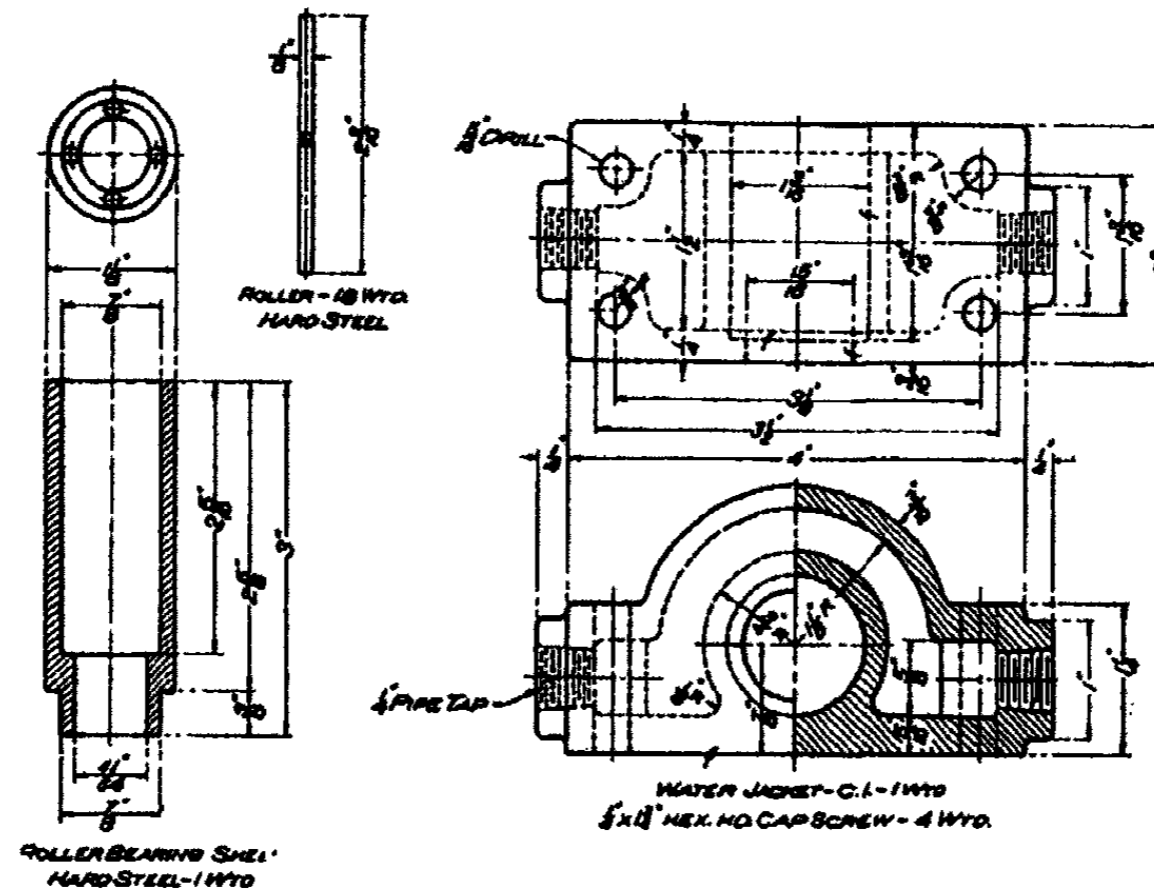

Fig. 3

side is grounded for lightning protection, it is necessary to insulate the pipe delivering water to this collar. This was accomplished by inserting in the line a short length of garden hose. The discharge pipe was prevented from touching the sewer pipe by slipping a rubber tube over the end for a short distance. Above the ball bearing A, Fig. 1, a collar was fastened to the shaft. This held the shaft up in the bearings.

This collar ended at the top in a horizontal plate which was screwed to the cone pulley, serving to hold the latter in place. The electrical connection was made by means of a copper bar 3-tenths of a square inch cross section, bolted to H, just behind the collar C. The contact surface was slightly over three square inches. On opposite sides of D, and receiving the current from the cathode, were brushes E, consisting of thin plates of copper laid one upon the other, aggregating

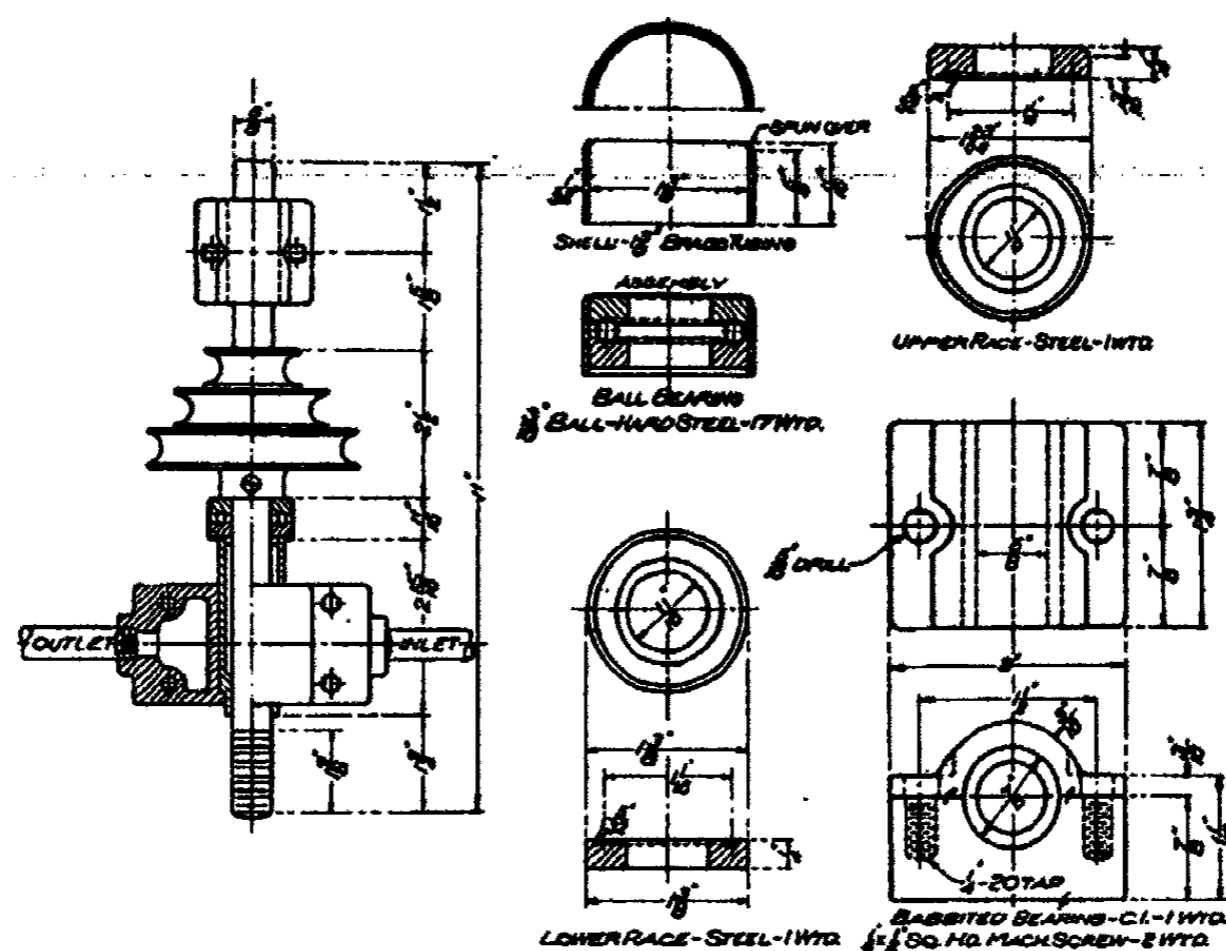

Fig. 4

sufficient size to carry 300 amperes. These were mounted, as seen, in holders which were in turn bolted to the front of H.

The anodes G, G consisted of two bars of metal about 7" long, 2 1/2" wide, and 1" thick. To these were bolted strips of copper which extended through a narrow slit in the cover of the container for the electrolyte. These strips were connected by another strip to which the electrical connection was made. The cathode F rotated in a 1 1/4" hole in the center of the cover. The cover consisted of a circular board 1"

thick, with a circular strip screwed to it, which fitted snugly inside the two-gallon earthenware jar which was used for container. This arrangement gave practically a seal for the jar so that there was no loss of electrolyte. Then too the anodes acted as baffle plates to break the excessive rotation of the liquid, the most rapid rotations being made without splashing the solution out.

The motor for rotating the electrode was mounted on the same frame with the apparatus previously described. It was found to require about one horse power to rotate the cathode, 6000 R. P. M. when immersed to a depth of about five inches in the electrolyte.

Where a rheostat was necessary, the arrangement K, Fig. 1, was found to be handy, flexible, cheap, and very compact. A post of wood held a spiral of No. 15 nickel wire by means of small screw eyes spaced equally around it. The wire was thus held out from the wood so that water could run in at the bottom, circulate around the wire and discharge at the top. From various points along the nickel spiral, copper leads were brought out to the binding posts at L. By changing these connections which could be done by a sliding switch the current could be raised to a desired point gradually. This device carried 150 amperes and dissipated about 10 kilowatts of energy as heat, without the slightest inconvenience. The wire would, no doubt, carry 300 amperes. However, for currents of 300 amperes a separately excited machine operating at any desired voltage was used and hence the resistance was cut out. The total volume of this rheostat to carry 300 amperes need be only about  $\frac{1}{4}$  of a cubic foot.

The aluminum as shown in Fig. 2 was found to be an ideal metal upon which to deposit other metals, it being covered with a voluntarily acquired film of oxide, which obviates the necessity of treating the cathode to prevent sticking of the deposit. The metal of course is deposited in a cylindrical shape of any desired thickness about the pipe



of aluminum. In order to get this cylinder of metal off whole, a thin shell of Rose's metal was cast around the aluminum. When the deposition was complete, the whole was dipped in boiling water, the alloy melted, and the metal cylinder lifted off. However, for physical tests, it being unlikely that the whole tube would be desired, the metal was deposited directly on the aluminum, and the following method adopted, for getting strips of the metal for tensile strength and ductility tests.

As can be seen from Fig. 2, the connector holding the aluminum pipe was unscrewed from the shaft, the rubber stopper was removed from the lower end of the pipe, and a brass plug, which was "centered" and tapered from the "centered" end, was driven in. The taper was so arranged that by slight pressure the plug fitted tightly inside the aluminum pipe. This done, the connector was "chucked" in a metal lathe, the center pin run up on the centered plug, and a section about an inch wide turned down in the center A, A, Fig. 2, to constant thickness. The whole was then removed and placed, in the same way as before, in a milling machine. Cuts were then made lengthwise through the metal as shown in Fig. 2 section A A. These strips were then pried off with a screw driver, the edges dressed down with a file, when, after measurements of the cross section, they were ready for physical tests. It was found more economical both of time and aluminum pipe, to cut almost through the copper to the aluminum below, on all save the last cut, where the fine adjustment of the machine was used and the copper cut completely through. After removing the metal the strips were broken apart by bending back and forth upon themselves. If a deep cut be made in the aluminum pipe, it is necessary, in order to get a perfect cylinder deposited the next time, to replace the pipe by a new one.

In conclusion, it may be said that

(1) A revolving cathode has been built which (a) will perform speeds up to 6000 R. P. M., (b) will carry 300 amperes,

giving a current density of about 3500 amperes per square foot when 4 inches of the cathode is receiving a deposit.

(2) The metal can be removed in good shape for testing physical properties without subjecting to strain of bending or heating.

This cathode was built at the suggestion of Professor Bancroft.

*Cornell University*

## TENSILE STRENGTH OF ELECTROLYTIC COPPER ON A ROTATING CATHODE

BY C. W. BENNETT

As early as 1865,<sup>1</sup> it was noticed that during electrolysis, if the cathode were rotated, a higher current density could be used. Among those actually making use of this was Wilde who patented a process in 1875, using for cathode a vertical iron cylinder which was rotated. The current density used in this process was never more than 20 amperes per square foot.

The next important commercial application of this principle was the Elmore process. In this, the cathode was a mandrel, rotating vertically, over which agate burnishers rotated, keeping the deposited copper tubes smooth, and of constant thickness throughout. This process is used commercially in Europe at present in the manufacture of seamless copper tubes. The current density used is not more than 30 amperes per square foot. The copper thus obtained has a tensile strength of from 36,000–50,000 pounds per square inch, depending, it is stated, on the speed of rotation.<sup>2</sup> However, a part of this increase in tensile strength, over that of copper precipitated on a stationary cathode, is most likely due to the increase in the rate of burnishing, for we have here a true analogue to the process of rolling. Due to the increased rate of rotation, the tube passes under the agate burnisher faster, thus giving more and more an approximation to the cold rolled copper, with its correspondingly higher tensile strength. The Dumoulin process substituted a burnisher of sheepskin for the agate of the Elmore process. It was claimed that the animal fat insulated the projections, thus tending to give a more even surface. The current density was run up to 40 amperes per square foot. No

<sup>1</sup> See "Electrochemical and Metallurgical Industry," 6, 412 (1908), for review of these processes.

<sup>2</sup> "Electrochemical and Metallurgical Industry," 3, 83 (1905).

mention is made of the strength of the deposit. This was tried commercially in England but failed completely.

Emerson in 1899 patented a process<sup>1</sup> for making a copper wire by plating copper on a rotating mandrel, wound around with a spiral of insulating material. The strip between the insulating material was then pulled off and drawn down. In 1899 the same man patented a process<sup>2</sup> for making copper bars. A copper strip was wound spirally around a cathode which was rotated. The strip was thickened to a bar by depositing the copper on it while rotating. A large (sic) cathode was rotated slowly.

S. O. Cowper-Cowles patented<sup>3</sup> practically the same process, using a smaller cathode and rotating it more rapidly. The United States Patent called for a process using a cathode moving "at such a rate of speed that will cause the hydrogen bubbles to be thrown off from the metal deposited on the cathode, and cause such friction between the metal deposited on the cathode and the electrolyte as to yield tough and smooth deposits."<sup>4</sup>

Using a cathode twelve inches in diameter rotating 1000 R. P. M., and an electrolyte of 12.5 percent copper sulphate and 13 percent sulphuric acid, at about 70° C, with a current density of 200 (preferably 170) amperes per square foot, copper foil was obtained which was even stronger than the best cold worked copper. The results would have been more conclusive if a thicker deposit had been precipitated and tested. The liability to error will be apparent when the thickness of an average sample is considered. This is given:

Dimensions Inches	Square inch	Tensile strength per square inch
1.109 × 0.006	0.0066	51,000 pounds

<sup>1</sup> U. S. Patent No. 395,773, January 8, 1899.

<sup>2</sup> U. S. Patent No. 638,917, 1899.

<sup>3</sup> English Patent No. 26,724, 1898; U. S. Patent No. 644,029, February 20, 1900.

<sup>4</sup> "Mineral Industry," 9, 229 (1900).

These results, as given, mean absolutely nothing in themselves, as will be seen below in the work on brass and bronze.

Five reasons are given for rotating the cathode.

(1) The electrolyte is stirred and impoverishment is prevented.

(2) The copper is burnished by the friction with the electrolyte.

(3) Foreign matter is eliminated, thus preventing "tree formation."

(4) Air bubbles are brushed away, thus preventing "nodule formation."

(5) Thickness of deposit is uniform.

There is little doubt that all of these factors enter in and tend to increase the tensile strength, and to enhance the character of the deposit. However, it seems highly improbable that the factors given above are the only ones entering into the equation. For this reason, it was deemed expedient to make some experiments, to see if other factors could be found, and to find their true relation to the tensile strength of the deposit. Then the principle was to be applied to the brasses and bronzes, with the hope that alloys of high tensile strength would be obtained.

With the copper the various factors were studied by holding others constant and varying one for a series of runs. In this way the effect of speed of rotation, current density, concentration of electrolyte, and temperature were determined. The apparatus consisted of an electrode holder designed to rotate continuously at any speed up to 6000 R. P. M., and carry 300 amperes. This has been described in a previous paper.<sup>1</sup>

For currents up to 150 amperes, the 110 volt circuit, from the university power house, was used. For the higher current, a motor generator set was used.

The test pieces were prepared by the general method outlined in the previous paper referred to above. These pieces ran from 0.040-0.060 inch thick. The actual deposit

<sup>1</sup> Jour. Phys. Chem., 16, 287 (1912).

before turning down was much thicker. The measurements of the cross section were taken with micrometer calipers, reading directly to 0.001 inch. These pieces were then broken in an Olsen testing machine. Five or more tests were made, and their average taken as the true tensile strength.

During the runs it was found necessary to burnish the deposit once or twice. A mechanical burnisher was not desirable, for it would be open to the objection that the copper was being "rolled" as in the Elmore process. Therefore it was deemed best to stop the run once or twice, depending on the relative rate of stirring and on the current density, and burnish with emery paper. This was done by holding the paper against the rotating tube. The surface was then washed, treated with a strong solution of potassium cyanide to remove grease, and then with 1 : 1 nitric acid solution to slightly roughen the surface and ensure the adherence of the next layer of copper deposited.

In general, if a solution be stirred during crystallization, the crystals resulting are smaller than those from the same solution without stirring, because more nuclei are formed. In depositing a metal, then, if it be precipitated directly in the crystalline state, we shall expect to get smaller crystals if the solution be stirred vigorously. However, the precipitation of the metal in the crystalline state directly, is not at all probable. It is likely that the metal comes down in a condition analogous to a "melt," and then crystallizes from this. By rotating the cathode the uncrystallized material is agitated and smaller crystals result. The force of the rotation tends to move the material, forcing it to develop new crystal centers, and in this way prevents the growth of large crystals. Hence in precipitating copper, smaller crystals were expected from the run where the rotation was rapid.

It is also known that the tensile strength of steel, copper, etc., is increased by rolling. Rolling, it is generally admitted, does nothing more than break down crystal aggregates, giving a more finely crystalline mass. Hence, with the

precipitated copper an increase of tensile strength was expected with a decrease of crystal size, as the rotation was increased. When this was tried the results showed that the theory was correct.

A solution containing 20 percent  $\text{CuSO}_4 \cdot 5\text{H}_2\text{O}$ , and 12 percent  $\text{H}_2\text{SO}_4$  was used. The temperature at starting was  $35^\circ\text{C}$ . This was desirable, for trial showed that this was the temperature maintained throughout a run at the current density used, *i. e.*, 500 amperes per square foot. The deposits were treated alike, and every precaution was used to keep all conditions, save speed of rotation, constant. Results for four runs are tabulated below:

CURRENT DENSITY 500 AMPERES PER SQUARE FOOT

Revolutions per minute	Voltage	Tensile strength in vertical direction Pounds per sq. in.	Tensile strength in direction of rotation Pounds per sq. in.
1750	3.2	37,000	—
2500	3.8	49,000	41,000
3500	4.7	51,000	51,000
5500	—	58,000	66,000

See Fig. 1 for curves representing these results. The voltage curve is discussed later.

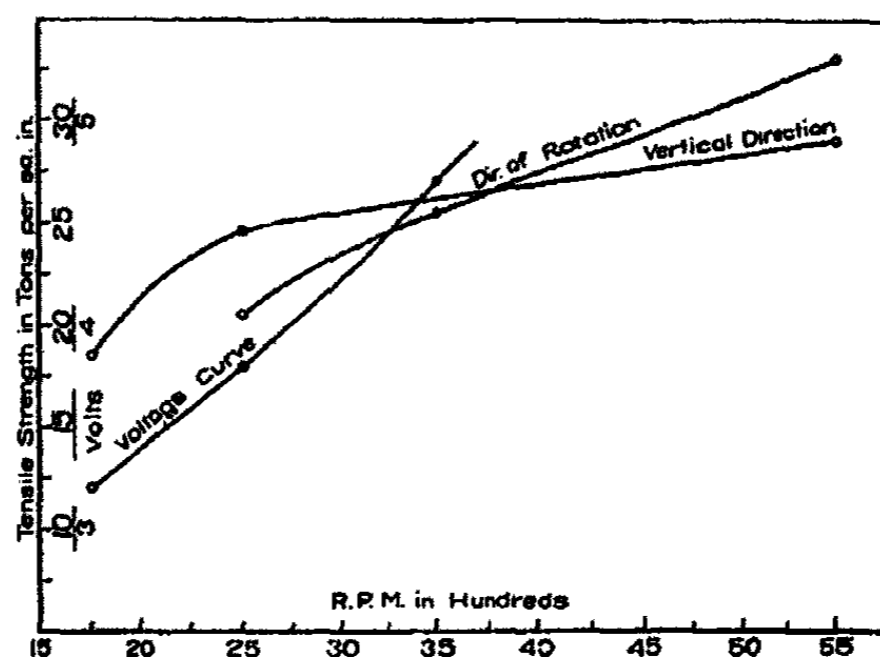

Fig. 1

A gradual increase in the tensile strength, with increased rotation of the cathode, is seen from the curves. There has been therefore a gradual decrease in the size of the crystals due to the increased rate of agitation of the uncrystallized matrix.

The observations given in the last column were taken to show that the theory, assigning the increase in tensile strength to the mechanical deformation of the crystals or particles of copper, by the friction against the solution, is untenable. This theory states that the particles are drawn out in the direction of rotation, and a fibrous interlacing mass is obtained. According to this, the tensile strength would be greatest in the direction of the lamination. The test pieces in the form of rings were cut off the bottom of the tube, while it was in the lathe. These were broken by applying pressure in the direction of a tangent. Fig. 2 gives a

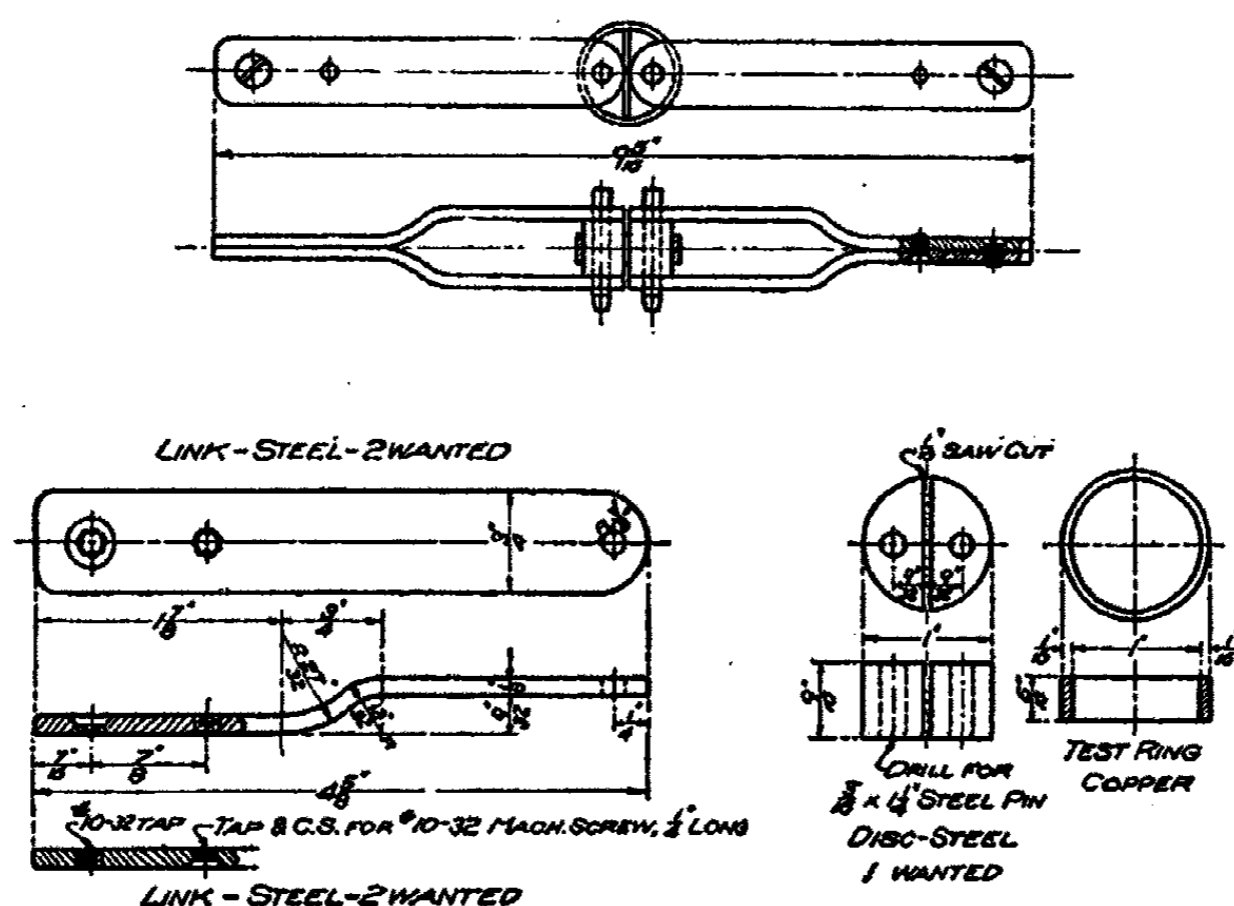

Fig. 2

sketch with detail of the apparatus used for these tests. This was prepared in the following way: A disk of steel 1" diameter and 9/16" thick was sawed through with a hack



saw, in the middle, giving two half discs. Holes were drilled in these, as shown in the figure, a little to the right and left of the centers of gravity of the sections. These were then fastened in two forks or brackets by pins, as shown. The brackets could then be held in the testing machine, the ring of copper slipped over the disc sections, the brackets pulled apart and the ring broken.

The breaking load was then divided by two, thus assuming that it was evenly divided. In the last run, at 5500 R. P. M., the difference is a bit greater than the experimental error and needs a little comment. At this rapid rate of rotation the solution is very violently agitated, and very fine bubbles of air are carried down into the solution. These are to some extent, most likely, entrapped and occluded in the copper. Now the bottom end of the cathode would receive the least amount of this air, and here the most compact deposit would be found, and consequently the tensile strength would be highest. This is the most probable explanation, for, on examination, the texture of the deposit at the end proved to be finer. Anyway, if the theory were true, all the measurements should be higher than those on the vertical strip, by an amount depending on the speed of rotation. Since they do not show this general tendency it may be concluded that the deformation of the crystals is not a factor.

In order to check up the inverse ratio of crystal size and tensile strength this series was polished, etched with ammonium hydroxide (1 : 3), and the crystal sizes and shapes noted under the microscope. It was hoped that the measurements of the actual size of the crystals could be obtained, but they were so small that the results would have meant nothing had they been taken. However, in passing along the series rapidly a decrease in the crystal size could be detected. When they were mixed, one could arrange the series by noting the crystal size under the microscope. No difference in the shape of the crystals could be seen, as would be expected according to the deformation theory. Again

the structure of the piece, from planes at right angles to each other, appeared to be the same. With the higher rates of rotation the deposit was smoother and better, showing that there was more efficient stirring and hence less impoverishment.

In Fig. 1, a curve is given, showing the voltage drop across the cell at varying speeds of rotation. An astonishingly large increase in voltage with increase in rotation is noted. The increase was more than was anticipated. It may be due to an increased resistance of the cell, or a back electromotive force. Increased resistance of the cell may be caused by an increase in the resistance of the brush contact, an air film on the cathode, or a tendency for the electrolyte to concentrate in the outer portion of the cell by being subjected to centrifugal force. These tendencies would increase with increased rotation. The back electromotive force may be due to frictional electricity, from the friction of the cathode against the liquid, or a more rapid solubility of the cathode than the anode. An increase in relative solubility of the cathode may be caused by the fact that the crystals at this electrode are much smaller than those of cast copper, or increased stirring, tending to equalize the concentration of the liquid about the cathode, and aiding diffusion, would allow the cathode to dissolve more rapidly than the anode, and thus set up a back electromotive force. Lastly the increased relative solubility of the cathode and anode may be due to a combination of the last reason with another. There may be an impoverishment with respect to copper ions in the film about the cathode. This then would give the cell,

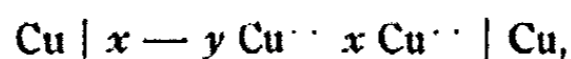

or a concentration cell, manifesting its electromotive force in a direction opposite the charging voltage. When now, the cathode is rotated, the increase in solubility may be greater than the reverse tendency, caused by stirring the solution faster, and consequently the final effect would be a total increase in the solubility of the cathode, and hence a higher

back electromotive force. Which and how many of these factors enter in, determining the increase in voltage, cannot be said at present. A detailed study of this, however, has been begun, and it is hoped that results will be forthcoming. This seems to be an important point in explaining some of the results gotten with revolving cathodes. These will be dealt with in detail in a future paper.

The variation of current density was then studied. It is generally known that rapid crystallization from a solution or "melt" gives smaller crystals than that which takes place more slowly. If now in depositing a metal the current density be increased, the amount of metal to crystallize in unit time is increased, and hence the crystals should be smaller. With the smaller crystals goes more even loading stress and hence higher tensile strength. Therefore, for any given set of conditions the tensile strength ought to increase as the current density is increased. The upper limit will depend on the rate of stirring, other things being equal. If this be true, the maximum tensile strength would be found at a higher current density, if the stirring were more vigorous. To show this, two series of observations were made, one at 2500 R. P. M., another at 5500 R. P. M. These were not, however, run under the same conditions. Due to the large current used, the temperature rise was found to be different in the series of the first run. To decrease this difference a higher initial temperature was used in the second series. The effect of this increase had been anticipated, and will be discussed under temperature, below. The desired point, however, is illustrated, that is, that the maximum tensile strength is obtained at a higher current density where the rate of rotation and hence rate of stirring is higher. The solution was the same as was used before. In the first series, the initial temperature was that of the room, in the last it was about 50° C. Results are tabulated below.

2500 revolutions per minute			5500 revolutions per minute		
Amperes per square foot	Voltage	Tensile strength pounds per sq. in.	Amperes per square foot	Voltage	Tensile strength pounds per sq. in.
300	2.5	60,000	340	2.7	34,000
400	3.3	68,000	500	3.8	50,000
510	3.9	40,000	1000	7.1	41,000
1100	7.2	35,000	1600	11.1	32,000
1700	12.2	14,000	2400	20.3	28,000
—	—	—	4000	27.5	13,000

These results are shown graphically by curves in Fig. 3.

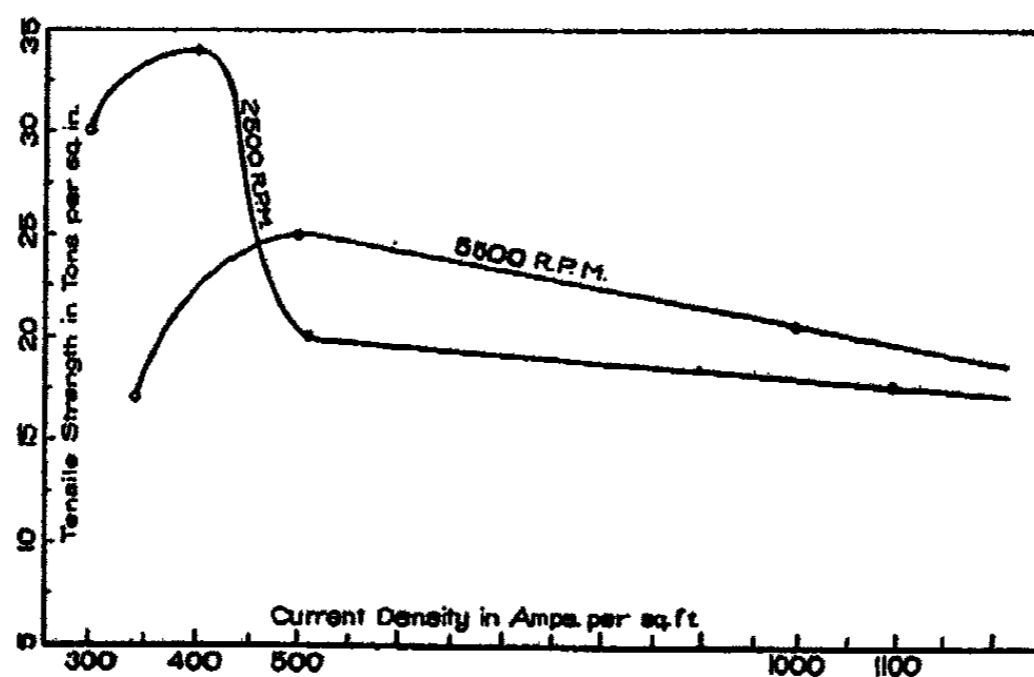

Fig. 3

The first three points were checked, that there might be no doubt as to the form of the curves. The tensile strength reaches a maximum and then drops off. This is due, no doubt, to the inefficient stirring, at the higher current densities. The current density was run up to a limit where the deposit was noticeably bad, due to the separation, probably, of cuprous oxide. The sample at 2400 amperes per square foot was very ductile, could be bent and worked nicely. No trace of oxide or other impurity was noted. The sample at 4000 amperes per square foot was brittle, but

worked nicely in the lathe giving a perfect copper surface. The fracture, however, showed a reddish brown color.

Upon examination under the microscope a gradual decrease in the size of the crystals with increase in current density could be noticed.

A few runs were made to show that variation of the concentration of the electrolyte makes little difference in the tensile strength. The following experiments were made, varying first the concentration of copper sulphate and then that of the sulphuric acid.

CURRENT DENSITY 500 AMPERES PER SQUARE FOOT.

Percent $\text{CuSO}_4 \cdot 5\text{H}_2\text{O}$	Percent $\text{H}_2\text{SO}_4$	Tensile strength Pounds per square inch
12	15	60,000
20	15	58,000
25	15	55,000
15	12	60,000
15	25	57,000

The last one of each series is a bit low, but this is due to the slightly elevated initial temperature required to hold the copper sulphate in solution. The current efficiency was not so good where a large percentage of acid was used.

Now as to temperature variation, which has been anticipated above. If copper wire be drawn while cold through a die, the effect is a decrease in ductility and an increase in tensile strength. This is caused by the breaking down of the large crystals giving smaller ones embedded more or less in amorphous material. The distance of shear through the crystal is relatively short, and hence the elongation is short, or in other words the ductility is slight. The tensile strength goes up, for the material is worked more or less toward the amorphous end, *i. e.*, the crystals become smaller and under stress show a more even loading. If the hard drawn copper wire be annealed, the tensile strength goes down to about 30,000 pounds per square inch as a limit, and the ductility is increased. The crystals become larger, the distance of

shear before they break is longer and hence the ductility is increased. By depositing copper on a rotating cathode, from a solution at room temperature, it is possible to duplicate the cold worked copper, getting a hard compact sample with a very slight ductility, and a high tensile strength. Now by raising the temperature of the solution and hence that of the uncrystallized copper deposited, it ought to be possible to anneal the metal, while it is being precipitated. Or looked at from the other point of view, crystallization from a hotter solution should give larger crystals, other things being equal. The following illustrates the principle admirably.

CURRENT DENSITY 500 AMPERES PER SQUARE FOOT

Temperature	Tensile strength
25° C	63,000 pounds per square inch
50° C	49,000 pounds per square inch
75° C	30,000 pounds per square inch

This is graphically illustrated by a curve, Fig. 4.

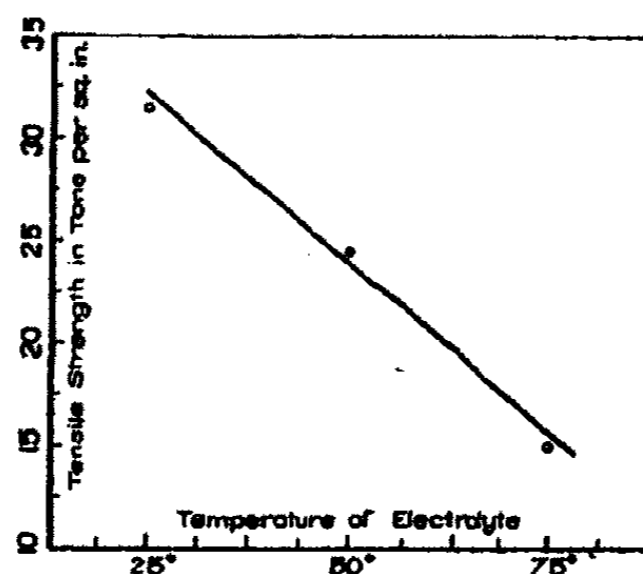

Fig. 4

The last sample, especially, was very ductile and soft, and very similar in properties to the annealed copper wire.

In this work at the current densities above 500 amperes per square foot, no attempts were made to cool the solution during the progress of the run. The large rise in temperature explains why the tensile strength at the higher current densities

was always low. The heat developed by the resistance of the solution keeps the temperature up, and anneals the deposit while forming. Under these conditions the maximum tensile strength is that of soft drawn copper, 30,000–35,000 pounds per square inch. The samples above 500 amperes per square foot, Fig. 3, were all ductile except the last ones of the two series, given at 2500 and 5500 R. P. M., respectively. Here the deposit was noticeably bad.

It was thought advisable to get an approximation of the current efficiency with the rotating cathode at a high current density. There being no evolution of gas at either electrode this was gotten by taking the ratio of the anode loss and cathode gain. Consequently, a run was made, using 1000 amperes per square foot, while the cathode was rotated 5500 R. P. M. The results follow:

Weight of anodes before	2582 grams	
Weight of anodes after	2529 grams	
Anodes loss		53.0 grams
Weight of cathode after	869 grams	
Weight of cathode before	816.2 grams	
Cathode gain		52.8 grams
$\therefore \frac{52.8}{53} = 99.6 \text{ current efficiency.}$		

The efficiency therefore is practically 100 percent.

Some runs were made with varying amounts of gelatine ( $\frac{1}{2}$ –5 grams per liter of solution) to see if the character of the deposit would be improved. Good conditions otherwise, that is, 400 amperes per square foot, at 2500 R. P. M., were used. The deposits, however, were very hard, and so brittle they could be crushed between the fingers. The brittleness was no doubt due to the mechanical deposition of traces of gelatine, with the copper. The gelatine is undoubtedly present here as a colloid. It is possible that the particles of copper become covered with a surface film of the gelatine, and are thus prevented from adhering to each other. Thus a "brick and mortar" structure would result, which could

easily be broken down. This is of importance in accounting for the results gotten with bronze, for here, too, there is certainly colloidal tin oxide present in the solution.

A run was made with copper nitrate and nitric acid, the concentrations of which were equivalent to 15 percent  $\text{CuSO}_4 \cdot 5\text{H}_2\text{O}$  and 12 percent  $\text{H}_2\text{SO}_4$ . A current density of 500 amperes per square foot, at 2500 R. P. M., was used. The deposit, however, was dark, hard and brittle.

In an attempt to apply the principle of rapid stirring and high current density, to the alloys of copper, bronze was studied. The first question was that of a solution from which to deposit the copper and tin. The solution recommended by Curry<sup>1</sup> was first tried. The solution contained 15 grams of  $\text{CuSO}_4 \cdot 5\text{H}_2\text{O}$ , 28 grams of  $\text{SnC}_2\text{O}_4$ , 5 grams of  $\text{H}_2\text{C}_2\text{O}_4$ , and 55 grams of  $(\text{NH}_4)_2\text{C}_2\text{O}_4$  per liter of water. The anodes were 90 percent copper and 10 percent tin. The current density varied from 20–200 amperes per square foot, but no satisfactory deposit could be obtained. At first bronze would be deposited, then the deposit became copper-rich until finally only copper was precipitated.  $\text{CuCl}_2 \cdot 2\text{H}_2\text{O}$  was substituted for  $\text{CuSO}_4 \cdot 5\text{H}_2\text{O}$  with only greater complications, for here we introduced the possibility of cuprous chloride. The conductivity of the solution was increased by adding ammonium chloride, but the character of the deposit was not enhanced.

There are two possibilities here. The tin may go in as stannous tin and be oxidized to the stannic condition, from which it would not be precipitated, or the tin may dissolve and become colloidal. If the latter be true, a copper-rich deposit should be obtained from the beginning, if the solution were boiled before the deposition was started. Here the tin in solution would be changed entirely to the colloidal state, and only copper would deposit. When this was tried the results indicated that the tin went bad, due to the formation of the colloid. A solution was made up as given above. One portion was electrolyzed, cold for a minute, and another, after being boiled, was run under identical conditions. A

<sup>1</sup> Jour. Phys. Chem., 10, 515 (1906).



bronze was obtained in the first case, while in the latter practically a pure deposit of copper resulted.

On account of the low conductivity of this solution it was deemed wiser to study the alkaline tartrate, for use in this precipitation. When the solution recommended<sup>1</sup> was tried, no deposit at all could be obtained. The sodium hydroxide concentration was high enough so that presumably it alone was decomposed. Some preliminary runs were made then, on a small scale, to determine the proper concentration of the various substances. Solutions containing copper sulphate and sodium stannate in the proportion of 90 parts of copper to 10 parts of tin, with enough sodium potassium tartrate to dissolve the whole easily, with varying amounts of sodium hydroxide, were electrolyzed with an anode of 90 percent copper, and 10 percent tin. These were run at a moderate current density using a rotating perforated platinum electrode. After running for at least 24 hours and after a deposit of constant composition was obtained, the deposits were compared, the solution giving the best bronze was analyzed, and this concentration used. This solution contained 22 grams of  $\text{CuSO}_4 \cdot 5\text{H}_2\text{O}$ , 5.5 grams of  $\text{Na}_2\text{SnO}_3$ , 150 grams of  $\text{NaKC}_4\text{H}_4\text{O}_6$ , and 5 grams of  $\text{NaOH}$  per liter. The anode analyzed 89 percent copper, the cathode 93.5 percent copper. From this and a consideration of the final tin content, a good part of the tin went into the electrolyte in the unavailable form, most likely colloidal. The deposit on the platinum was brittle. However, about 50 grams of a compact deposit was obtained, which showed very nearly the same composition throughout. The solution above being used, runs were made with 6, 18, and 30 amperes per square foot, but the deposits were too brittle to get a measurement of the tensile strength. The relative amounts being the same, the solution was made five times more concentrated, in order to increase the conductivity, and runs were made at 150 and 250 amperes per square foot. The deposits were no better, however. The trouble here is most likely due to the colloidal material.

<sup>1</sup> McMillan: "A Treatise on Electrometallurgy," p. 287.

This may be mechanically deposited with the bronze and prevent adherence, as the gelatine with the copper. Colloidal tin or tin oxide is no doubt present, for the tin content in the solution gradually goes up, showing that it is going into solution in an unavailable form. Tests applied for stannic tin were negative. When this is taken up again, the question of a solution is the first one to be answered. A systematic search should be made for a solution of high conductivity, where the chances for the formation of colloidal material and stannic tin are negligible, and for one, from which a deposit of constant composition can be gotten. Any attempt to use ~~the solution given above is useless if a bronze with good physical properties is desired.~~

The next attempts at the application of the foregoing principle of rapid stirring and high current density were the study of brass. The solution used here was one of the double cyanides of copper and zinc with excess of potassium cyanide. This solution, 85 grams of  $ZnSO_4 \cdot 7H_2O$ , 35 grams of  $Cu(CN)_2$ , and 130 grams of KCN per liter, was electrolyzed with brass anodes containing 60 percent copper and 40 percent zinc. The current density varied from 12-150 amperes per square foot, with a rotation of 2500 R. P. M. Only one deposit was tough enough to test. A measurement was obtained on the run at 75 amperes per square foot. The average of two tests gave 9,500 pounds per square inch. Two pieces were annealed at 800° C for 8 hours and quenched, and then tested. Curiously the tensile strength went up. The average of two measurements gave 18,000 pounds per square inch. There has been a change in the piece other than the growth of the crystals, otherwise the tensile strength would have gone down. The fracture of the unannealed piece was interspersed with brownish black specks and lines which disappeared when the piece was annealed. It is possible that the piece as deposited had interspersed through it, probably as a film around the crystals, some decomposition product of the cyanide solution, which was driven out by annealing at the temperature used. At least, the curious reversal must

have been due to the freakishness of the unannealed piece, since its tensile strength was very much too low for unannealed alpha brass. A sample was also heated to redness by passing an electric current through it. The tensile strength was increased, as when the piece was annealed. The disturbing film around the metal was most likely burned out.

Some runs were made with anodes, well over in the alpha field, 70 percent copper and 30 percent zinc, with more rapid stirring, but the deposit was very brittle. In practically all runs with brass, the first thin film of the deposit was very good. It was foil that could be bent into any shape. This was not tested because the results would have meant nothing, since the deposition could not be carried on indefinitely. The solution must change soon after the electrolysis is started. What this change is, or how it is brought about, is not known.

What was said of the bronzing solution applies also to those for brass-plating. For this high current density work, it seems that an acid solution with very soluble salts of the metals will have to be found. While these experiments on the alloys have not been satisfactory in any respect, they at least point out some lines along which work would be fruitless.

#### Conclusion

These experiments have shown that:

(1) Copper has been deposited electrolytically at a current density of 4000 amperes per square foot or about 430 amperes per square decimeter.

(2) In the electrolytic precipitation of a metal the crystal size decreases as the cathode is rotated more rapidly, other things being equal.

(3) The crystal size decreases as the current density increases, and increase as the temperature rises.

(4) The concentration of the electrolyte can be varied quite a little without changing the character of the deposit.

(5) If the precipitation is carried on at a high temperature an effect similar to annealing is accomplished during the electrolysis.

(6) The tensile strength of metals varies inversely as the crystal size, and hence any factor tending to decrease the crystal size tends to increase the tensile strength.

(7) The effect of rapidly rotating the cathode and of increasing the current density is to increase the tensile strength, the crystal size being decreased.

(8) A good deposit of copper could apparently be obtained at an infinite current density if the stirring were efficient enough to prevent impoverishment.

(9) The current efficiency at a high current density with rapid rate of rotation is high, it being 99.6 percent.

(10) "Hard drawn" copper can be deposited on a rotating cathode at almost any current density, if the temperature be kept down; and likewise annealed copper, if the temperature be kept at about 75° C.

(11) Electrolytic copper has been obtained having a tensile strength of 68,000 pounds per square inch.

(12) A deposit as good as the best can be obtained with a current density of 2400 amperes or more per square foot, with the rate of stirring used.

(13) With the alloys, the trouble is most likely a question of colloidal material.

(14) Acid solutions, with readily soluble salts, and no possibility for the formation of colloids should be sought for as electrolytes in alloy precipitation.

This work was suggested by Professor Bancroft and carried out under his supervision, to whom, with Professor Upton of Sibley College, I wish to express my sincere thanks for advice and suggestions. Thanks are also due to Sibley College for coöperation by giving me the use of apparatus and machine shops.

*Cornell University,  
Ithaca, N. Y.*

## ELECTRICAL ENDOSMOSE

BY WILDER D. BANCROFT

Perrin<sup>1</sup> has made the generalization that all porous diaphragms become charged positively in a solution which is sufficiently strongly acid and become charged negatively if the solution is sufficiently strongly alkaline. This is the same as saying that electrical endosmose will carry the acid solution through the diaphragm from cathode to anode and will carry the alkaline solution through the diaphragm from anode to cathode. I do not intend now to discuss whether this generalization is or is not absolutely accurate for all diaphragms; but I do wish to show how certain apparent exceptions may be accounted for.

If we take an acidified copper sulphate solution and a porous cup we find that electrical endosmose carries the solution through the walls of the cup from anode to cathode which is not the direction that Perrin's law would lead us to expect. On the other hand the solution passes to the anode if we substitute copper nitrate and nitric acid for the corresponding sulphates. The sign of the charge on a diaphragm depends on the relative adsorption of cation and anion, being positive if the cation is adsorbed to a greater extent than the anion and negative if the reverse is the case. Let us assume that, for equal concentrations, hydrogen as ion is adsorbed somewhat more readily than sulphate as ion, while copper as ion and nitrate as ion are only adsorbed to a relatively slight extent. In that case the diaphragm will be charged positively in sulphuric acid and in nitric acid; but will be charged negatively in copper sulphate. Electrical endosmose will then carry sulphuric acid and nitric acid solutions to the anode and a copper sulphate solution to the cathode, which is what happens. An acidified copper nitrate solution will also move to the anode because hydrogen as ion will be the de-

<sup>1</sup> Jour. Chim. Phys., 2, 601 (1904).

acidifying factor. The situation is different with an acidified copper sulphate solution, especially if the concentration of copper sulphate is high and that of sulphuric acid is low. Since the adsorption of sulphate as ion increases with increasing concentration, there will come a point at which sulphate as ion is adsorbed more strongly than hydrogen as ion. The charge on the diaphragm will then reverse and electrical endosmose will carry the solution through the diaphragm from the anode to the cathode, which is what happens experimentally.

This enables us to explain some facts observed by Reed ten years ago. A containing vessel was divided into three compartments by means of two porous diaphragms. In the anode compartment there was a copper sulphate solution (sp. gr. 1.17) slightly acidulated with sulphuric acid. The other two compartments contained  $H_2SO_4$  solution (sp. gr. 1.17). "Immediately on closing the circuit and causing a current to flow through the apparatus both the volume and the weight of the solution in the middle compartment begin to rapidly increase and continue to increase at an apparently uniform rate as long as the current flows. Even with a current of about  $\frac{1}{2}$  ampere per square inch of cross-section of electrolyte, the increase in volume amounts to 1.7 cc in 1 hour." Electrical endosmose would carry the sulphuric acid solution from the cathode compartment to the middle compartment. At the anode compartment we should have the copper sulphate solution tending to be carried into the middle compartment while the sulphuric acid solution would tend to be carried back into the anode compartment. The total transfer through this diaphragm will therefore be the difference of the two and will depend on the actual conditions in the diaphragm at any moment. I am inclined to believe that there will be a flow of solution from the anode compartment to the middle compartment; but the details are not sufficiently accurate to enable one to be certain of this. It is clear however that there must be an increase in the amount of solution

<sup>1</sup> Trans. Am. Electrochem. Soc., 2, 238 (1902).

in the middle compartment and that electrical endosmose is the important factor in Reed's work.

Perrin<sup>1</sup> has found that a saturated solution of barium carbonate moved to the anode through a chromic chloride diaphragm. Since such a solution is slightly alkaline by hydrolysis, the movement is apparently in the wrong direction. This might be due to barium as ion being adsorbed to a greater extent than hydroxyl as ion. An experiment made for me by Mr. Briggs disproved this assumption, because a barium hydroxide solution moved to the cathode through a porous cup. The only possible explanation then was that this was analogous to the case of copper sulphate and sulphuric acid. Let us assume that hydroxyl as ion is adsorbed a little more readily than barium as ion while carbonate as ion is only slightly adsorbed. The total concentration in a saturated barium carbonate solution is low; but the amount of hydrolysis is not very large and so the ratio of barium to hydroxyl is rather large and we therefore have conditions favorable to barium being adsorbed more than hydroxyl. To test this Mr. Briggs took a barium chloride solution and added a small amount of barium hydroxide. This solution moved slowly to the cathode through a porous cup, which was not what it should have done; but we found that dilute acid behaved similarly with this diaphragm so that the alkaline solution does behave like a dilute acid. We hope to repeat this experiment some day, using a chromic chloride diaphragm. It was also found that a barium hydroxide solution passes much less rapidly than a sodium hydroxide solution having the same hydroxyl concentration. Since we know that barium is adsorbed much more readily than sodium, this is exactly as it should be.

Müller and Bahntje<sup>2</sup> found that, in acidified copper sulphate solutions, starch and gum arabic did not move to the cathode and did not cut down the size of the copper crystals when the solution was slightly acid; but did both these things

<sup>1</sup> Jour. Chim. Phys., 2, 643 (1904).

<sup>2</sup> Zeit. Elektrochemie, 12, 320 (1906).

when the solution was made more acid. The movement of the colloid to the anode in a slightly acid solution is just what happened with the porous cup. Of course the reversal will come at different degrees of acidity with different colloids. In fact, Müller and Bahntje found that gelatine moved to the cathode in solutions in which starch moved to the anode. The effectiveness of gelatine in cutting down the size of lead crystals in the Betts process is due largely to the fact that the solution is markedly acid. It has been claimed that gelatine has no effect on the quality of the deposit from lead acetate solution; but this of course can only be due to faulty experimental considerations. To prove this Mr. Bennett, at my suggestion, made up two solutions containing 10 percent lead acetate and 5 percent acetic acid. To one solution there was added 1 percent of glue. The two solutions were then run in series, using lead electrodes, the current density being 0.3 amp/dm<sup>2</sup>. The beneficial effect of glue was very marked.

Aluminum sulphate is often added to zinc baths to improve the quality of the zinc deposit. The explanation for this has been given by Schlötter.<sup>1</sup> "Since aluminum sulphate is dissociated hydrolytically, in aqueous solution, into sulphuric acid and colloidal aluminum hydroxide, the action of aluminum sulphate is clearly that of a colloid. We get a similar result when copper is deposited electrolytically in presence of aluminum sulphate." Though Schlötter does not mention it, it seems certain that the action of tin salts<sup>2</sup> in a copper bath comes under the same head. It seemed as though a good way of confirming this would be to predict in regard to an entirely new case. If we boil a ferric acetate solution we shall get a certain amount of colloidal ferric oxide. If we add this to an acidified lead acetate solution, it ought to cut down the size of the lead crystals obtained by electrolysis. Mr. Bennett was good enough to try this experiment for me. He made up the following solutions:

A. Ten percent lead acetate and 5 percent acetic acid.

<sup>1</sup> Galvanostegie, 1, 38, 51 (1910).

<sup>2</sup> Borchers: "Elektrometallurgie," Third Edition, 193 (1903).



B. Three grams ferric acetate and a few drops of acetic acid made up to 70 cc boiled and filtered.

In one beaker was placed 300 cc A and in a second 300 cc A + 50 cc B. The two solutions were run in series at 43° with a current density of 0.3 amp/dm<sup>2</sup>, using lead electrodes. The deposit was distinctly better from the solution containing colloidal ferric oxide, though the ferric oxide is not as efficient as gelatine.

Another point that we can now clear up is the electrolytic precipitation of black, pulverulent copper from a dilute copper sulphate solution. In my paper<sup>1</sup> on "The Chemistry of Electroplating" I was forced to leave this point unsettled. We know that it is not due to the simultaneous precipitation of hydrogen because we get all the copper out of certain copper sulphate solutions as a good deposit when we are doing electrolytic analysis. It cannot be due to the low concentration because the concentration of copper as ion in a complex salt is much lower. If we have a dilute, nearly neutral copper sulphate solution, we shall have certain amounts of hydrolysis and a certain formation of colloidal cupric oxide. Within certain limits this will be beneficial to the deposit, just as a certain amount of gelatine is beneficial. If we get in too much gelatine, we get a black deposit instead of a brilliant one. If we get too much colloidal cupric oxide relatively to copper as ion, we shall also get a black deposit. The favorable conditions are a dilute and nearly neutral solution. When we are determining copper electrolytically from a sulphate solution, the excess of acid cuts down the hydrolysis to a negligible amount. Hydrolysis is also prevented if we have a complex salt of copper; and if the solution is neutral or alkaline, there is normally no tendency for the colloid to pass to the cathode. The same reasoning applies also, to a greater or lesser extent, to other metals. Of course one is not justified in concluding that all black deposits are necessarily the result of hydrolysis.

Since the iso-electric concentration is the one at which

<sup>1</sup> Bancroft: Jour. Phys. Chem., 9, 282 (1905).

the anions and cations are adsorbed in equivalent amounts, it follows that we cannot draw any conclusions in regard to single potentials from measurements of the iso-electric point except for the special and somewhat improbable case that we have a zero adsorption of anions and cations.<sup>1</sup> This is also the explanation for the flowing electrode mercury not giving true single potentials.<sup>2</sup> Another interesting consequence is that we can no longer maintain that the potential difference between a metal and an aqueous solution is a function of the concentration of the ions of the metal only. It will vary to some extent with the nature of the anion and with the nature of the other cations present in so far as these are adsorbed by the metal in question.

*Cornell University*

<sup>1</sup> Cf. Billitzer: *Zeit. phys. Chem.*, 45, 327 (1903); 48, 513, 452 (1904); *Drude's Ann.*, 11, 902 (1903). Goodwin and Sosman: *Trans. Am. Electrochem. Soc.*, 7, 83 (1905).

<sup>2</sup> Smith and Moss: *Phil. Mag.*, [6] 15, 478 (1908).

## PORE DIAMETERS OF OSMOTIC MEMBRANES

BY F. E. BARTELL

The fact that some grades of porcelain act "osmotically" was clearly demonstrated by Graham.<sup>1</sup> He made use of a porcelain cylinder of about 170 cc capacity, to which was attached an outlet tube, calibrated in mm, for measuring the change of height of the solution. This apparatus was filled with the solution to be tested, then placed in a jar of distilled water the temperature of which was held between 56° and 64° Fahr. Some of the results obtained are as follows: A solution containing 1 percent of Rochelle salt produced a rise in the column of 82 mm; phosphoric acid of the same strength, gave 62 mm; sugar and other organic substances gave something less than 20 mm.

Notwithstanding the fact that certain grades of porcelain do produce osmotic effects when tested, it is also true that most grades of porcelain do not produce apparent osmotic effects. The difference in the behavior of the porcelain consequently raises the following questions: What is characteristic of that porcelain which is capable of producing osmosis? Is the *composition* of the porcelain or the *internal structure* the principal factor, and if the latter, is there any definite relation between the size of the pores in porcelain and osmotic effects?

Relatively little attention has been given to such membranes as porcelain, marble,<sup>2</sup> etc., with which, owing to the fact that they permit much of the dissolved substance as well as the solvent to pass through, the osmotic effects are slight and the results are only qualitative. The main object of recent investigators appears to have been to determine whether or not the gas laws apply to osmotic pressure.

The purpose of this investigation is not to determine the

<sup>1</sup> Phil. Trans., 144, 177 (1854).

<sup>2</sup> Can stone and marble membranes were used by Dutrochet in his investigations of osmotic phenomena (Ann. Chim. Phys., 49, 411 (1832)).

maximum osmotic pressures, then compare them with gaseous pressures; it is to study some of these relatively neglected membranes from a different point of view, to study their structure and to compare this with their ability to produce osmotic effects however small. The aim is to add a little, if possible, to our knowledge of how a membrane acts when osmotic phenomena are observed.

In a previous article<sup>1</sup> a brief account was given of results obtained in a study of the relation of the size of the pores in porcelain to the osmotic effects produced. The membranes investigated were porcelain, porcelain clogged with barium sulphate, and porcelain clogged with sulphur. Numerous tests have since been made with these membranes. Also, the work has been extended to include membranes of porcelain clogged with lead chromate, with lead sulphate, with copper sulphide and with copper ferrocyanide.

The object of this paper is to describe, briefly, some of the preliminary experiments which led to this investigation, to give the results obtained in recent investigations and to point out the limits of accuracy of the method and the precautions to be observed in measuring pore diameters by this method.

#### **Preliminary Experiments**

Discs cut from ordinary unglazed porcelain drying plates were sealed over the mouth of a thistle tube which was then filled with a normal sugar solution, placed in distilled water and tested for ability to give osmotic effect. These were found to give no osmotic effects. Other discs, made from battery cups and some other grades of porcelain, when tested in a similar manner, gave marked osmotic effects. These discs were then examined under the microscope and it was readily seen that the porcelain producing the osmotic effect was that with the finest texture. It seemed altogether probable that the porcelain with the finest texture was also of smallest pore diameters. It also seemed reasonable to

---

<sup>1</sup> Jour. Am. Chem. Soc., 31, 1194 (1909).

suppose that if the size of the pores makes the difference, osmotic effects should be obtained from a plate, which alone will not show osmotic effects, provided its pores be sufficiently clogged with some insoluble material. With these considerations in mind a series of experiments were undertaken.

*Experiment 1.*—A small porcelain disc, about 25 mm in diameter was cut from an unglazed porcelain plate and sealed, by means of marine glue, over the mouth of an ordinary thistle tube. The bulb of the tube was then filled with a normal sugar solution. The osmotic cell thus prepared, was set up in a beaker of distilled water for osmotic tests. The height of the liquid in the tube was adjusted to the same height as the water outside. Twelve hours later the solution was 5 mm below the surface of the water. After 48 hours the column had returned to practically its original position and at the end of six days had risen not more than 2 mm, a height ascribable to capillary ascension in the glass tube.

*Experiment 2.*—A porcelain disc made from the porcelain of fine texture previously mentioned, was treated in the same manner as the porcelain in Experiment 1, and set up for osmotic tests. At the end of 12 hours the column had risen 24 mm; at the end of 24 hours, 45 mm; at the end of 40 hours, 72 mm; at the end of 96 hours, 98 mm.

*Experiment 3.*—Water was forced through the porcelain disc, used in Experiment 1, to remove the sugar solution. A solution containing freshly precipitated barium sulphate, formed by treating  $M/2$  barium chloride<sup>1</sup> with  $M/2$  sodium sulphate, was forced through under pressure. This was followed by more water to remove any excess of solution remaining. The cell was then filled with  $M$  sugar solution and set up for osmotic tests as before (Experiment 1). At the end of 2 hours the column had risen 3 mm, and after 24 hours it stood at 15 mm.

*Experiment 4.*—Another disc, cut from the same porcelain

---

<sup>1</sup>  $M$ , is used to indicate molecular normal, being preferred to the more commonly used symbol  $N$  which occasionally leaves one in doubt whether molecular normal or equivalent normal is meant.

as the first, giving no osmotic effect in its original condition, was placed in  $M/2$  barium chloride solution for 1 hour. It was then transferred to an  $M/2$  sodium sulphate solution where it remained for 40 minutes. Water was forced through to remove the solutions present, then the disc was tested for osmotic effect. After standing 12 hours the column had risen 28 mm; after 24 hours it had risen 45 mm.

*Experiment 5.*—A solution containing a finely divided precipitate of sulphur, formed by treating a sodium thio-sulphate solution with dilute sulphuric acid, was forced through another such disc. This disc gave somewhat more marked osmotic effects than those in the preceding experiments. After 12 hours the column stood at 24 mm; after 24 hours, at 60 mm; and after 48 hours, at 85 mm.

From the above experiments it is evident that by clogging the pores of the coarse grained porcelain we can make it act "osmotically." This, then, is in favor of the view that the internal structure, or the pore diameter, is one of the main factors in determining the ability of a porcelain membrane to give osmotic effects. Let us assume that the pore diameter is the principal factor. It then follows: (1) That by clogging the pores with any insoluble precipitate, whatsoever, we should be able to make any porcelain act "osmotically." (2) That the border line between osmotic effect and no osmotic effect should be indicated by a definite pore diameter. With pore diameters larger than some maximum, no osmotic effects should be obtained; with pore diameters smaller than this maximum, osmotic effects should be obtained.

#### Method for Calculating Pore Diameters

The results obtained from an investigation of the permeability of porcelain membranes showed that Poiseuille's laws for the passage of liquids through capillary tubes apply to the passage of water through porcelain.<sup>1</sup> By making use of Poiseuille's formula  $Q = \frac{KD^4PT}{L}$ , (in which  $Q$  represents

<sup>1</sup> Jour. Phys. Chem., 15, 659 (1911).

the quantity of liquid passing through a tube of  $L$  length and  $D$  diameter in  $T$  time under  $P$  pressure), and solving for  $D$ , it is possible to estimate the diameter of the pores in a membrane. It is, however, impossible to obtain correct numerical values for  $L$ , the length of the pores, for it cannot be assumed that the pores in a membrane are arranged as straight tubes perpendicular to the faces of the membrane. The average length of the pores is probably much greater than this, therefore, we are unable to obtain anything like absolute values by this method.

The method finally adopted for measurements of pore diameters in membranes was one based upon the application of Jurin's law, which gives us a means for calculating diameters of capillary tubes, independent of their lengths.  $a^2 = h r$ , where  $r$  is the radius of the tube,  $h$  the height to which liquid ascends due to capillarity, and  $a^2$  is one of the so-called capillary constants. For water at  $20^\circ\text{C}$   $a^2 = 14.823$  mm. Suppose, for example, that the radius of the tube is 1 mm, then water will rise in that tube to the height of 14.823 mm. To force water out of such a tube will require the hydrostatic pressure of a column of water of this same height. Furthermore, if water fills a very short piece of capillary, of this same diameter, the same pressure will be required to force it out. By measuring the pressure required to force water out of a membrane saturated with water we can estimate the diameter of the pores in that membrane.

The applicability and accuracy of this method was demonstrated experimentally.<sup>1</sup> Fine glass capillaries were drawn out, filled with water, and the pressure necessary to force out this water with air was determined. Later these same tubes were measured directly under the microscope. A close agreement between the calculated and observed diameters was obtained.

It is obvious that this method is applicable only to the investigation of membranes strong enough to withstand the pressures, *i. e.*, membranes with relatively large pores. Some

<sup>1</sup> Jour. Am. Chem. Soc., 31, 11 (1909).

of the porcelain discs used in this investigation burst at pressures little above ten atmospheres. In case the pores were of approximately molecular dimensions, assuming that capillary laws would apply for these diameters and also assuming  $10^{-7}$  cm to be the order of molecular magnitudes, the pressure required to force the water out would be in the neighborhood of three thousand atmospheres (as a matter of fact the pressure would be much greater than this owing to molecular attraction). It is thus altogether improbable that the precipitation membranes capable of giving osmotic pressures comparable with those calculated from the gas laws, would withstand the pressure requisite to estimate the diameter of the pores. Pressures and corresponding pore diameters are shown in Table I.

Column I, contains the pressure (kilograms per square centimeter), calculated as necessary to force water out of capillaries with diameters given in Column III.

TABLE I

I Pressure	II Temperature	III Diameter in microns
1	20° C	2.9646
2	20° C	1.4823
5	20° C	0.5930
10	20° C	0.2964
25	20° C	0.1186
100	20° C	0.0296
1000	20° C	0.0029

#### Apparatus

The membranes investigated were, in most cases, different grades of unglazed porcelain. The pressure required to force water out of them was determined with an apparatus as shown in Fig. 1.

The holder containing the membrane which was to be investigated was attached at H. Pressures, applied by means of compressed air from tank T, were read directly from the pressure gauge, E. The porcelain plates were about 4 mm



in thickness and were held between washers of dermatine (DD, Fig. 2) which left exposed a surface 14 mm in diameter. The cell proper was a thick walled glass cylinder, G, 40 mm

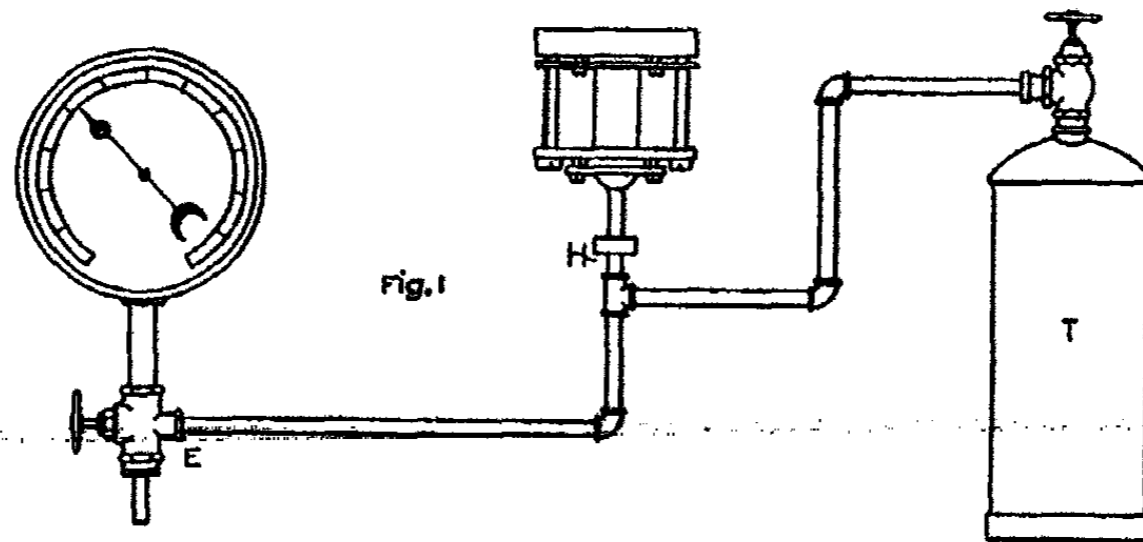

long and 14 mm internal diameter, with ground ends which rested on washers of dermatine. The rest of the holder was of brass held together by means of screws. The holder was so constructed that the porcelain plate remained in position during the entire course of an experiment.

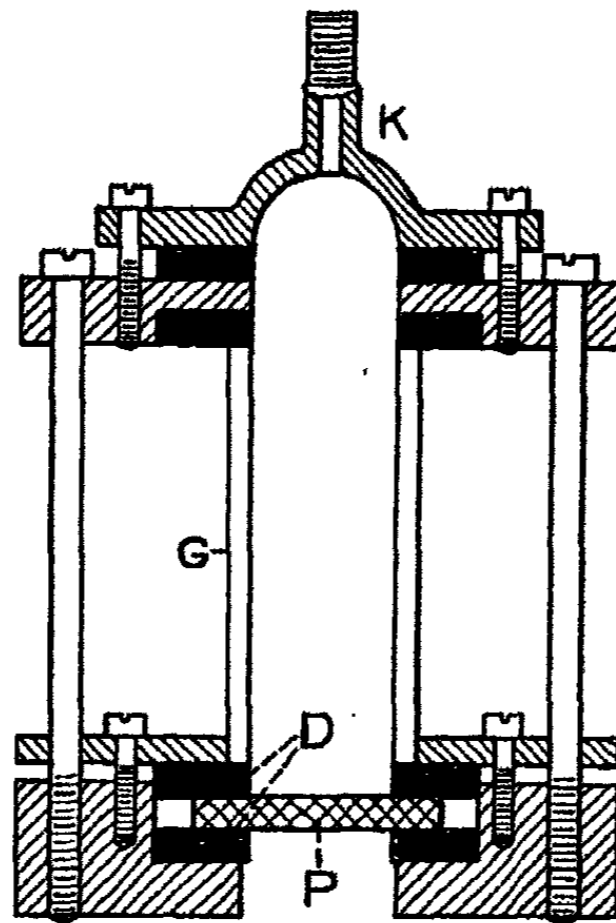

Fig. 2

When the apparatus was set up for osmotic tests the threaded outlet tube K, was replaced by a glass tube 100 mm in length and 3 mm internal diameter. This glass tube was held firmly in place by a washer of dermatine which was in turn securely fastened by a brass washer.

#### **Method of Operation**

In carrying out an experiment, the porcelain plate was fastened in place in the holder then thoroughly saturated with water. The holder was then attached to the pressure apparatus with the plate facing upward. A piece of thick plate glass was placed above this for when high pressures were employed the porcelain discs frequently burst. Gradually increasing air pressure was brought to bear on the under side of the membrane. As water was forced out of the pores, air bubbles came through; these were most readily detected by having a thin layer of water on the upper side of the plate, and watching with a lens. The pressure at which the first bubble appeared was noted, but for the calculation of the pore diameters the pressure was taken at which 100-125 bubbles came through. After the pressure required to force the water out with air had been determined, the cell was disconnected from the pressure apparatus, filled with normal sugar solution, adjusted for osmotic tests and placed in a 600 cc beaker of distilled water. The apparatus was thus converted into an "osmotic cell" experiment without disarranging disc or cylinder. The meniscus of the sugar solution within the tube was adjusted to the level of the water in the beaker. If the meniscus rose to a height greater than 5 mm (an ascension of this amount was considered to be greater than could be accounted for by capillary ascension or change in the temperature) the membrane was considered capable of producing osmotic effects. As a rule, readings were taken every 12 hours; in every case the cell was allowed to stand at least 24 hours before conclusions were drawn.

In both the pressure experiments and the osmotic tests the temperature was held close to 20° C and did not vary

more than one degree either way. Pressures were measured in kilograms per square centimeter, therefore, substituting in the formula,  $D = \frac{a^2 \times 2}{P \times 10^4}$ , gives the diameter of the pores in millimeters.

#### Measurement of Pore Diameters in Porcelain

Discs from more than 80 samples of porcelain were prepared, the pore diameter of each disc was determined, after which tests were made for osmotic effects.

The range of pressure employed from the appearance of the first bubble until so many bubbles had appeared that it was impossible to accurately count them was, in most cases, comparatively small. Pressures together with corresponding pore diameters, obtained with one sample of porcelain, are given in Table II.

TABLE II

Column I. Pressure in kilograms per square centimeter.  
 Column II. The diameter in microns of a capillary corresponding to the pressure.  
 Column III. The number of bubbles in a circle of 14 mm diameter.

I Pressure	II Diameter	III Number of bubbles
7.0	0.422	None
7.4	0.400	None
7.6	0.388	5
7.7	0.383	15
7.8	0.378	75
8.0	0.369	120
8.2	0.360	Too many to count

The calculated diameter for the five largest pores in this porcelain was 0.388 microns. The value obtained for an innumerable number was 0.360 microns. This, of course, does not exclude the possibility that there are yet more much smaller. In recording results of experiment the value 0.369 would be taken.

It was also found that, with porcelain of approximately

the same grade as that used in the preceding experiment, it was advisable to wait at least five minutes after each successive increase of pressure before making a final count of air bubbles. It takes some time to force the water out of the pores as is shown by the data in Table III. The disc used here was the same one used in the above experiment; its average thickness was 5.45 mm. Pressure was held constant throughout. Column IV, gives the time in minutes that the pressure was allowed to act.

TABLE III

I Pressure in kg	II Diameter in microns	III Number of bubbles	IV Time in minutes
8	0.369	None	1
8	0.369	1	1 <sup>3</sup> / <sub>4</sub>
8	0.369	10	2
8	0.369	30	2 <sup>1</sup> / <sub>2</sub>
8	0.369	50	3
8	0.369	120	4
8	0.369	120	5
8	0.369	120	6
8	0.369	120	8

With this plate the least time for the appearance of the maximum number of bubbles was about four minutes.

The method employed to saturate the porcelain plates with the liquids, was to put the porcelain in a beaker of the liquid, then set the beaker under a bell jar and evacuate the jar by means of a Geryk pump. Under diminished pressure the air bubbles in the porcelain expand and the air comes out of the pores allowing them to fill with the liquids when subjected to atmospheric pressure again. This method is more satisfactory than attempting to drive out the air by forcing the liquid into the plate, for in the latter process air, held in recesses of the porcelain, becomes compressed and is not removed.

#### Results

Table IV contains some of the results obtained with different samples of porcelain.<sup>1</sup> P, represents the pressure

<sup>1</sup> Eighty-one different samples of porcelain were used in this series.

in kilograms per square centimeter and D, the diameter of the pores in microns.

TABLE IV—PORCELAIN

P	D	Osmotic effect
2.5	1.18	None
2.6	1.14	None
3.0	0.99	None
3.6	0.83	None
3.8	0.78	None
4.0	0.74	None
4.5	0.65	None
5.0	0.59	None
5.5	0.54	None
6.0	0.49	None
7.0	0.42	Possibly a slight effect
7.6	0.39	Surely some effect
8.0	0.37	More effect
8.5	0.35	Marked effect
9.0	0.33	Marked effect
15.0	0.19	Greatest effect

The results show that if the diameter of the pores is more than the 7 kilo value (0.42 microns) there is no osmotic effect, while if the diameter is less than this there is osmotic effect; also the smaller the pore diameter the greater the osmotic effect. Never less than three, and in some cases as many as ten, independent experiments were carried out with each grade of porcelain.

*Method of Clogging Pores of Porcelain.*—The porcelain discs used for the precipitation membranes had pore diameters of 1.18 microns and gave no osmotic effect when tested alone with normal sugar solution. Three distinct methods were used for clogging the pores of the porcelain. (1) A solution containing the finely divided precipitate was forced through with air pressure until sufficient clogging was effected. (2) The two solutions used for precipitation were placed on opposite sides of the disc, allowed to penetrate and form a precipitate at the point of meeting. (3) The disc was first saturated with one of the solutions then placed in the other

solution. The last method seemed to offer the best means to control the extent of clogging.

*Barium Sulphate Precipitate in Porcelain.*—Porcelain discs, of such coarse grain that when tested they gave no osmotic effects, were selected and their pores were clogged by precipitating barium sulphate within them. These plates were first saturated with an M/2 barium chloride solution under diminished pressure. They were then placed in a solution of sodium sulphate for some time, after which sodium sulphate solution was slowly forced through with air pressure. Water was forced through to remove the solutions present. The length of time, pressures employed, as also the concentrations of the solutions, were varied in order to obtain discs with varying degrees of porosity. Table V, contains results obtained with membranes of porcelain clogged with barium sulphate.

TABLE V—BARIUM SULPHATE

P	D	Osmotic effect
3.0	0.98	None
3.5	0.84	None
3.8	0.78	None
4.0	0.74	Slight effect
4.8	0.62	Slight effect
5.0	0.59	Marked effect
6.0	0.49	Marked effect
12.0	0.24	Marked effect

With this modified membrane the border line between osmotic effect and no osmotic effect is near the 4-kilo value (0.74 microns).

*Sulphur Precipitate in Porcelain.*—Porcelain plates of the same degree of porosity as those used in the preceding experiment, were clogged with a precipitate of sulphur. The plates were first saturated with a solution of sodium thio-sulphate by evacuation, then dilute sulphuric acid was forced through with air pressure, after which water was forced through to remove excess of both reagents. Also, in some of

the experiments, a solution containing finely divided sulphur was forced through in order to produce the clogging.

Table VI, contains some of the results obtained with these membranes.

TABLE VI—SULPHUR

P	D	Osmotic effect
3.2	0.93	None
4.0	0.74	None
4.5	0.66	None
5.0	0.59	Possibly a slight effect
6.0	0.49	Surely some effect
8.0	0.37	Marked effect
12.0	0.25	Marked effect
14.0	0.21	Marked effect
18.0	0.16	Marked effect

When the diameter of the pores was greater than that represented by the 5-kilo value (0.59 microns) no osmotic effect was obtained. In all cases when the diameter was less than this, osmotic effect was obtained.

*Lead Chromate Precipitate in Porcelain.*—The pores of coarse grained porcelain were clogged with a precipitate of lead chromate. The plates were first saturated with M/2 lead nitrate solution, under diminished pressure. They were next placed in an M/2 solution of potassium dichromate for a few minutes, then potassium dichromate solution was forced through the plate with air pressure. Water was forced through to remove excess of solutions. Table VII gives some of the results.

TABLE VII—LEAD CHROMATE

P	D	Osmotic effect
3.0	0.98	None
3.4	0.85	None
3.6	0.82	None
3.8	0.78	Possibly slight effect
4.0	0.74	Marked effect
4.2	0.72	Marked effect
4.4	0.68	Marked effect
5.0	0.59	Marked effect

*Lead Sulphate Precipitate in Porcelain.*—Porcelain discs were saturated with M/2 lead nitrate solution under diminished pressure. The discs were then placed in sodium sulphate solution for lengths of time varying from 5 seconds to 1½ hours. By varying the time in this manner it was possible to regulate the extent of clogging. The results of two series of experiments, together with the average osmotic effects of these are shown in Table VIII.

TABLE VIII—LEAD SULPHATE

No. exp.	P	D	Osmotic effect <sup>1</sup> (24 hours)		
			Series I	Series II	Average
1	2.6	1.13	None	None	None
2	3.0	0.984	None	None	None
3	3.2	0.923	7	8	7.5
4	3.4	0.868	16	None	8
5	3.8	0.777	19	5	12
6	4.0	0.738	9	15	12
7	4.4	0.671	22 (109)	12	17
8	4.8	0.615	35	10	22.5
9	5.0	0.591	23	33	28
10	8.0	0.369	23	12	18
11	10.0	0.295	28	—	28

The cells were allowed to stand for several days. It was noted that the osmotic effects in experiments 1, 2, 3, 4, and 5 had reached a maximum at the end of 24 hours. None of the other membranes with somewhat smaller pore diameters showed a maximum at the end of this time. For example, at the end of eight days the cell in Experiment 7, showed a rise of 109 mm and had, apparently, not yet reached a maximum.

*Copper Sulphide Precipitate in Porcelain.*—To form the precipitate, porcelain discs, saturated with M/2 copper nitrate solution, were placed in ammonium sulphide solution for varying lengths of time. Table IX, contains results obtained in a single series with copper sulphide membranes.

<sup>1</sup> Osmotic effect is represented by the rise in mm of the sugar solution.



TABLE IX—COPPER SULPHIDE

P	D	Osmotic effect (48 hours)
3.2	0.92	None
3.4	0.86	None
3.6	0.82	None
4.0	0.73	1
4.2	0.70	3
4.4	0.67	2
4.8	0.61	18
5.4	0.54	4
5.6	0.52	8
5.8	0.50	11
6.0	0.49	16
6.4	0.46	7
7.2	0.41	19
7.4	0.40	14
8.0	0.37	16

*Copper Ferrocyanide Precipitate in Porcelain.*—Two distinct methods were used for precipitating copper ferrocyanide within the porcelain. In one series, the disc was saturated with M/2 copper nitrate solution, M/2 potassium ferrocyanide solution was then slowly forced through with air pressure, after which the two solutions were forced through alternately. Results obtained with these membranes are given in Table X, Series I. In the other series, solutions of lead nitrate and potassium ferrocyanide were placed on opposite sides of the membrane and allowed to penetrate and form a precipitate at the place of meeting. Results obtained by this method are given in Series II.

Corresponding results in the two series do not agree as closely as might be expected. This divergence is undoubtedly due to the difference in the methods employed in forming the precipitates.

In experiments with some of the so-called insoluble crystalline precipitates it was found that the precise treatment during the clogging of the pores has much to do with the magnitude of the osmotic effects obtained. Unfortunately, however, similar methods could not be used in all the experi-

TABLE X—COPPER FERROCYANIDE<sup>1</sup>

P	D	Osmotic effect (24 hours)	
		Series I	Series II
2.8	1.05	None	None
3.0	0.98	None	—
3.2	0.92	None	4
3.4	0.86	None	45
3.5	0.84	—	9
3.6	0.82	None	12
4.0	0.73	5	—
4.2	0.70	24	52
4.4	0.67	7	—
6.0	0.49	—	42
8.2	0.36	—	58
16.0	0.18	90	—

ments for the various precipitates require different treatment in order that the clogging of the porcelain may be of approximately the same degree, *i. e.*, in order that we may obtain discs with 100–125 pores with diameters near the border line between osmotic effect and no osmotic effect.

It should be mentioned, also, that experiments have been carried out with some "insoluble" precipitates which have not been entirely successful owing to the fact that sufficient clogging could not be effected with the methods thus far employed. Among such precipitates may be mentioned calcium oxalate and silver chromate.

*Calcium Oxalate.*—Porcelain discs, with pore diameters of 1.18 microns, were treated with solutions of calcium chloride and ammonium oxalate using all the methods for clogging previously described. After many attempts the pore diameters were finally reduced to 0.74 microns. These membranes when tested gave no osmotic effect.

*Silver Chromate.*—Solutions of potassium dichromate and silver nitrate were used with the porcelain of the porosity mentioned in the preceding experiment. After repeated

<sup>1</sup> The blank spaces in Table X, indicate that no experiments were made with membranes of corresponding pore diameters.

attempts pore diameters of 0.82 microns were obtained. Attempts at further clogging were not successful. As was to be expected, these membranes failed to give apparent osmotic effects when tested.

#### A Comparison of Results

A comparison of the results obtained in this investigation is given in Table XI.

TABLE XI

Membrane	Border line	
	Pressure	Pore diameter
Porcelain	7.0	0.422
Porcelain and sulphur	5.0	0.591
Porcelain and BaSO <sub>4</sub>	4.0	0.738
Porcelain and PbCrO <sub>4</sub>	3.8	0.777
Porcelain and PbSO <sub>4</sub>	3.2	0.923
Porcelain and CuS	4.0	0.738
Porcelain and Cu <sub>2</sub> Fe(CN) <sub>6</sub>	3.2	0.923

The border line between osmotic effect and no osmotic effect is not quite the same for the different membranes, however, the values are of the same order of magnitude and probably agree as closely as could be expected, for comparatively large errors are possible in determining the pressure at which 100-125 bubbles appear. Since these values are not the same it cannot be definitely stated that the nature of the substance makes no difference, but they are so nearly the same that the pore diameter seems to be one of the main factors in determining the appearance of osmotic phenomena. The success in finding within rather narrow limits a pore diameter which, if exceeded, unsuits the membrane for demonstrating osmotic effects does not preclude the following possibility. Perhaps it is only through the pores of molecular dimensions that pure water passes through to the solution while the solution as a whole is leaking outward through all larger pores. When the inflow equals the outflow no change in level is observed; when the inflow slightly exceeds the outflow a change in

level is observed. Perhaps what was measured in this investigation was the pore diameter at which the "leak" was just a little less than the osmotic effect.

**Summary**

The maximum pore diameter with which apparent osmotic effects can be obtained was determined with membranes of plain porcelain and membranes of porcelain clogged with insoluble precipitates. A definite area (1.54 sq. cm) was investigated in every case. It was found that when there were 100-125 pores in this area with diameters greater than 0.923 microns, no osmotic effects were obtained.

The border line between osmotic effect and no osmotic effect seems to be practically the same for membranes clogged with insoluble crystalline precipitates and for those clogged with the so-called "semipermeable" precipitates.

In conclusion, the writer wishes to express his gratitude to Professor S. L. Bigelow for his interest and advice throughout the progress of this investigation.

*University of Michigan,  
Ann Arbor, Mich.*

## NEW BOOKS

**Theoretical and Physical Chemistry.** By *S. Lawrence Bigelow*. 14 X 22 cm; pp. xiii + 525. New York: The Century Company, 1912. In the preface the author says:—

"Many fundamental principles which apply in all branches of chemistry are given in the first course, but, of necessity, they are presented more or less didactically. Students at that time have so small a knowledge of the facts of chemistry they cannot be expected to understand the significance of these principles, and they usually forget them quickly. In the Sophomore or Junior year conditions are otherwise, and at this stage they appreciate a critical consideration of these half-learned, three-quarters forgotten, fundamental principles, and both value and enjoy following the reasonings which lead to others. Such critical studies develop the habit of right thought and tend to diminish the number of those who memorize and recite parrot-fashion but will not think. For these reasons the writer believes a course of lectures in elementary, theoretical and physical chemistry should follow the first courses in general chemistry and qualitative analysis.

"This book is intended for use in such a course and is addressed to students who know a little chemistry. It comprises about all that can be advantageously presented in two or three lectures a week through one year, but it is hoped it may be found useful for shorter courses or collateral reading.

"An unfortunate impression has got abroad that much mathematics is needed for a comprehension of physical chemistry; unfortunate, as it deters many who want it, and would profit by it, from electing the subject. No attempt has been made to avoid the use of mathematics, but a perusal of this book will show that ordinary arithmetic and elementary algebra are sufficient, except in five or six demonstrations. One unfamiliar with the calculus must take it on faith that steps in the derivations of half a dozen formulæ are correct, and that is all.

"Classifications and methods of presentation which have proved satisfactory by their results should not be tampered with unless for clearly good cause. My colleagues will therefore recognize many familiar statements and arrangements in the following pages. But the book is not wholly devoid of novelties. In lecturing over this ground repeatedly for the last thirteen years, the facts arranged themselves, automatically as it were, in four subdivisions. The first section (three chapters) aims to show the value of philosophy in science. In the second section (seven chapters) the ever-present question is: What are the ultimate constituents? In the third section (nine chapters) we are, primarily, studying the properties of substance as such, and in the last section (eleven chapters) our attention is centered upon the processes by which substances become what they are.

"The most difficult part of the task has been the selection of topics to omit. The title of almost every chapter is the title of a book, some of them works in several volumes. The attempt was made to select the salient facts and principles of each branch, and to construct from these a picture, intended to

give a fair idea of the character of the information to be obtained by pursuing each subject further.

"Believing it to be generally true that the value of items of knowledge is directly proportional to the simplicity with which they can be presented, most earnest efforts have been directed to show the inherent simplicity of some ideas, too often hermetically sealed under forbidden names and a maze of technical terms. Some may feel that this has resulted in too great disregard of a few time-honored terms, perhaps even a ruthlessness with one or two accepted elaborations. Criticism on this score will not be disagreeable, rather the reverse; for it is the plain duty of teachers and writers to make the truths and thoughts they have to impart as simple as they can. Ideas surrounded by a fog of terms and formulae, through which only a select few can find the way, are open to suspicion as to their worth. We are obliged to coin too many new terms as it is, and any multiplication of them, not absolutely necessary, tends to establish a sort of monopoly which is abhorrent to the ideas of science."

The book is divided into four sections. The first is entitled the principles of science and contains chapters on: the name, scope and value of our subject; the scientific method; fundamental definitions. The second section is devoted to stoichiometry [special spelling] and contains chapters entitled: unit quantities of chemistry and chemical notation; the atomic and molecular theories; chemical energy, affinity, and valence; the periodic system; spectroscopic evidences and the theory of inorganic evolution; luminiferous ether and vortex rings; radioactivity and the electron theory. The third section has to do with properties and the headings of the chapters are: gases; vapor densities; liquids; index of refraction; solids; solutions I—osmotic phenomena and the theory of dissociation in solution; solutions II—rotation of the plane of polarized light; solutions III—solid solutions; solutions IV—colloidal solutions. The fourth section deals with processes and is about as long as the other three put together. The chapters are entitled: liquefaction of gases; vapor pressure; some elementary thermodynamic deductions; vapor pressure of solutions; the process of solution and precipitation; velocities of chemical reactions; equilibria in chemical reactions; thermochemical data; electrochemistry I—the quantity factor; electrochemistry II—the intensity factor; actino-chemistry.

The deduction of formula weights, p. 46, is quite free from dogmatism and is much better than the more orthodox one. It is interesting to read, p. 78, that "these different valences are nothing but the necessary consequences of the artificial rules we have laid down for ourselves for the purpose of selecting symbol and formula weights." The discussion of varying valence, p. 80, is however so condensed that it is doubtful whether many can profit by it. On the other hand, the author is clear enough in his warning, p. 82, in regard to structure formulas. But for lack of space the reviewer would like to quote the passage from Crookes, p. 97, in regard to the rules of the game. The change of color of a heated body with changing temperature is given much more definitely, p. 100, than is usually the case. For special reasons the reviewer was very much pleased with the paragraphs on multiple spectra, p. 106, and on the second spectrum of hydrogen, p. 107. Under cathode rays, p. 114, the author has taken pity on the student and has explained how it is that one can have a cathode when starting with an alternating current.

On p. 149 there is a very instructive graphical table of magnitudes, with stellar distances at one end and electrons at the other. On p. 174 we find the following paragraph: "Imagine a gas partly dissociated. An undissociated molecule in the hotter portion of the containing tube dissociates, thus taking up heat. It arrives at a cooler zone and there associates, thus giving up this heat. In other words, the conduction of heat should be more rapid when a gas is partially dissociated than when it is either not dissociated at all, or is completely dissociated." This is exactly the line of reasoning used by Langmuir in his work on hydrogen.

The soap bubble experiment, p. 180, is a good one and it is a pleasure to find the author taking the ground, p. 181, that "it seems plausible to suppose that there must be degrees of wetting and unlikely that a liquid either does not wet a solid at all or wets it as thoroughly as any other liquid would wet it." On p. 183 there is a discussion of the tears of strong wine and also a description of how to remove grease spots with benzene. In order to account for the behavior of solutions in presence of membranes, p. 220, the author makes the statement "that it is possible to look upon a liquid, or solution, as a capillary structure, for there must be space between the molecules else it would be continuous, infinitely divisible, and we should have to abandon our molecular theory." Some of us would prefer that alternative.

On p. 244 attention is called to the fact that Dubrunfaut anticipated Graham in regard to dialysis. On p. 269 the author says that "if we watch for it, we may frequently see a small cloud grow to many times its size. It is surprising how few appear to have observed this common phenomenon." This may be true; but the phenomenon was well known in scriptural times. On p. 287 there is the common misstatement that it has been found impossible to superheat any solid above its melting point.

On p. 320 we find Menzies' very ingenious vapor pressure apparatus; on p. 365 there is an excellent discussion of kindling temperature and of spontaneous combustion; and on p. 388 attention is called to the fact "that the affinity constants of the ammonium bases when dissolved in aniline, a solvent in which we have reason to believe there is very little dissociation, come out in just the same order as in water." The author might well have called attention also to the behavior of hydrochloric acid and the substituted acetic acids in aniline.

The author gives a deduction of the theorem of iso-hydric solutions, p. 459, which is more than its inventor did; but he does not point out the limitations even by a reference. He gives a very sane account, p. 480, of the status of the calomel and the hydrogen electrodes.

Good as the book is, there are points on which the author has gone wrong and there are also points on which the reviewer thinks that the author has gone wrong. A typical instance of this latter is in regard to colloids, pp. 37, 245. The reviewer does not believe that colloidal solutions pass without change into true solutions. As the author has most of the scientific world on his side, it is perhaps not profitable to dwell on this point. When discussing the volume term in the van't Hoff formula, p. 212, a reference to what van't Hoff originally said would not have come amiss. Some reference should have been made somewhere in the book to the effect of the heat of dilution on apparent molecular weights. On p. 307, the diagram will hardly "tell us just what will happen if

we attempt to distil these mixtures." Unless the compositions of the coexisting phases are given we cannot tell whether we can separate two liquids in finite time or not.

On p. 350 the author is discussing the distribution law and he speaks of the concentration of a saturated solution of bromine in carbon bisulphide; but he does not tell us what that concentration is or how one would determine it. The author has apparently forgotten that bromine is miscible in all proportions with dry carbon bisulphide. On p. 395 the author says that "there are cases where the facts do not correspond to the deductions from the solubility product. We cannot imagine that the fault lies with the premises of the law of mass action, nor in our methods of formulating equilibria." This is an unfortunate attitude to take in view of the work of Arrhenius. The proof, p. 403, that a catalyzer cannot displace the equilibrium is faulty because it assumes that no work is done in removing the catalyzer from the sphere of action.

These mistakes are annoying but perhaps they are covered by the words in the preface that "my colleagues will recognize many familiar statements." These errors are to be found either in Ostwald's *Lehrbuch* or in Nernst's, often in both, and they have been repeated so often that they might almost claim to rank as axioms because they cannot be proved.

The chapter on actino-chemistry is the weakest in the book. It is not true, p. 505, that no case has yet been found where violet light certainly oxidizes a metallic compound, unless the author means to bar out the ultraviolet and he is using the word violet in contradistinction to red. It is not true, as one would gather from this book, that a coarse-grained emulsion is always faster than a fine-grained one. On p. 249 the author implies that an emulsion contains sodium bromide and silver nitrate while ripening. The reversal of the image, p. 512, is not due to a hardening of the gelatine. The theory of chromated gelatine, p. 514, has been cleared up pretty thoroughly by Lumière and Seyewetz. Ozone is formed in the silent discharge by the action of ultraviolet light, so the analogy between high electric tension and high temperature, p. 422, drops out. Langley's work on the firefly certainly deserves something more than the statement, p. 518, that "it is assumed that all energy is converted into light without loss by this insect."

When we consider the book as a whole, there is a temptation to ask whether it might not be better to cover less ground and to cover it more in detail. There might be a good deal said for this point of view but the argument against it is that, in all human probability, the student will never get the things that are crowded out. However that may be, the fact remains that the author set himself a perfectly definite task and that he has carried it out in a first-class manner. The book is a credit to the author and would be a credit to anybody. The author has done a big thing in a big way, and he has written what is unquestionably the best book of its size on the subject. *Wilde D. Bancroft*

*Handbuch der Mineralchemie. By C. Doelter. Vol. I: Parts I-IV: 18 x 25 cm; pp. 160 (each part). Dresden: Theodor Steinkopff, 1911. Price: 6.50 marks (each part).*—In the introduction to this new treatise the author points out that the first developments of mineralogy were made by chemists. As the crystallographic side became more prominent, mineralogy became more distinct



from chemistry. We have now entered on a new stage of development in which the formal description is less important than the question as to the synthesis and stability of minerals. This being primarily a problem in physical chemistry, the chemistry of mineralogy is the important thing and this treatise lays stress on this side of the subject.

In the four numbers of the first volume which have appeared, the subject is treated under the headings: carbon; carbonates; silicates. In accordance with the plan of the book, there is given a good deal which one would have difficulty in finding anywhere else in a collected form. A striking instance of this is the citation of the phosphorescence and triboluminescence of different minerals. Of course different people will get different things out of the volume. The reviewer, for instance, was very much interested in the paragraph, p. 321, on the different etch-figures obtained with different acids. The diagram, p. 233, showing Brill's data for the dissociation pressures of magnesium carbonate makes one wonder whether all these alleged compounds really exist or whether the work is not vitiated by a progressive agglomeration or something of that sort. We have reason to believe that there is a red phosphorus for each temperature that one chooses to study. Pretty much the same thing is probably true for artificial graphite. There are unquestionably hysteresis phenomena connected with the dissociation of calcium carbonate, so why not in the case of magnesium carbonate?

On p. 79 the author gives Tucker's figures for the temperature at which carborundum is formed and breaks down. There is a long discussion of graphite, p. 73, and a very interesting one on the formation of diamonds. There is a reference to mineralizers on p. 602 and a frank confession that we have as yet no theory in regard to their action.

The author has secured a large and efficient staff of collaborators and the completed work should be of great value to chemists and to mineralogists. Its value would probably be enhanced somewhat if there were a more appreciative view taken of the work of the Geophysical Laboratory.

*Wilder D. Bancroft*

**Wolfram.** By Heinrich Leiser. 18 × 25 cm: pp. 222. Halle: Wilhelm Knapp, 1910. Price: 12 marks.—The author has written this monograph on tungsten because he believes that the commercial applications of this interesting metal will not long be limited to high-speed steels and lamp filaments, important though both these uses are.

The subject is treated under the following heads: occurrence of tungsten ores; technical extraction of the metal and its salts; chemistry of tungsten, analysis of tungsten; physics of tungsten; tungsten and the colloids technical application; tungsten alloys; minor technical applications. The author has done his task well and almost any chemist will find something of interest to him in the book. Among the minor uses for tungsten is in X-ray tubes. Since tungsten has the double advantage of high melting point and high specific gravity, it seems certain that tungsten will displace platinum completely in this industry.

For those who are interested in the theoretical problems, one can recommend the study of the tungstic acids, pp. 43, 135. One cannot help wondering whether the borotungstates, etc., really are definite compounds.

*W. D. B.*

**The Chemistry of the Radio-Elements.** By Frederick Soddy. (*Monographs on Inorganic and Physical Chemistry.*) 14 × 21 cm; pp. 92. New York: Longmans, Green and Co., 1911.—This is the first of a new series of monographs edited by Findlay. The editor says that "to those engaged in guiding the reading of advanced students of chemistry, the difficulty of obtaining adequately summarized accounts of the progress made in recent years, more especially along certain of the more actively pursued lines of advance, becomes ever more acutely felt. So great has now become the volume of chemical investigation, and so numerous the channels of its publication, that not only the Honours Student but also the worker desirous of undertaking Research in one or other department of his subject, feels it a growing difficulty to become *au fait* with the present state of the more important and more strenuously cultivated regions of his Science. To assist these two classes of students—those reading for an Honours Degree, and those undertaking Research—is the main aim of the present Series of Monographs."

"In this Series of Monographs it is hoped to place before advanced students of chemistry, accounts of certain sections of Inorganic and Physical Chemistry fuller and more extended in scope than can be obtained in ordinary text-books. Exhaustive treatment of the different subjects, however, so far as concerns work important in its time but now only of historical interest, will not be attempted; the chief attention will be given to recent investigations."

The subject has been treated under the headings: general description of radioactivity; radioactive constants, periods of average life and radioactive equilibrium; classification and nomenclature of the radio-elements—analogies between the three disintegration series.

On p. 2 we read that "the sum total of radioactivity is not affected by any operation yet tried. In spite of the existence at one time of a vague belief (a belief which has no foundation), that all matter may be to a certain extent radioactive, just as all matter is believed to be to a certain extent magnetic, it is recognized to-day that radioactivity is an exceedingly rare property of matter."

On p. 5 there is an outline of the present theory of radioactivity. "The radio-elements are unstable and change spontaneously, the change being accompanied by the expulsion from the original atom of 'rays' and the production of a new type of radioactive atom. The latter is often very much more unstable than the parent element, and changes again with expulsion of rays and formation of another new atom. This process of successive changes proceeds often through a great number of steps. Thus an  $\alpha$ -ray is expelled in the change producing thorium X, the thorium X atom expels another  $\alpha$ -ray and changes into the gaseous emanation, the emanation atom expels another  $\alpha$ -ray and changes into the non-volatile matter constituting the active deposit, which in turn undergoes further changes of precisely similar type. The extension of this view has gradually included all the known phenomena of radioactivity. The thirty new types of radioactive matter before mentioned which occur in the uranium and thorium minerals are all almost certainly produced from either uranium or thorium by this process of successive changes. Lacunae still remain to be filled. The production of radium and of actinium from uranium has not yet been directly

observed, but there is strong indirect evidence that it occurs, and that time alone is required for the experiments to yield positive results."

On p. 24 the author says: "It may be urged that although an infinitesimal quantity of ionium, to take one case, behaves, when mixed with a relatively enormous excess of thorium, like the element thorium itself in all respects, the chemical nature of ionium, if it were possible to prepare it from thorium, might be quite different. Every worker at the present time no doubt has formed some more or less tentative opinion on this important point, and such opinions, if set forth, would no doubt be very different, according to the personal experiences of the worker. The one expressed in this section must be taken rather as an individual opinion than as a settled judgment. It may be remarked that the common present-day method of separating a radio-element from a mixture by adding deliberately its nearest chemical analogue and separating this, has rather tended to close the avenue of knowledge as to the real chemistry of the radio-elements, and for this reason the work of Auer von Welsbach under the Austrian Government on the pitchblende residues, in which this method was purposely not employed, is of considerable interest. The amounts of thorium, for example, which he separated from the residues of many tons of pitchblende were so small, that there is little doubt that they must have contained a considerable percentage, if not actually a predominance, of its more radioactive twin-brother ionium.

"The vague idea that infinitesimal amounts of radioactive matter may possess a chameleon-like nature, reflecting the properties of the substances with which they are mixed rather than their own, is not justified. The properties of the radio-elements, and with certain reservations to be referred to, their behaviour under any defined set of conditions, is at least as definite as those of the common elements."

These quotations give a fair picture of the merits of the book and of the demerits of the style.

*Wilder D. Bancroft*

*Laboratory Exercises in Physical Chemistry.* By J. N. Pring. 13 × 19 cm; pp. xii + 162. Manchester: University Press, 1911.—Twenty-two pages of this book are concerned with measurements of molecular weights by measuring the decrease in vapor tension, and measurements of the density of a gas and of a liquid. Eleven pages are then given to calorimetry. The remainder, about one hundred and twenty pages, is given up to electrochemical phenomena. Calibration, the storage battery, analysis, single potentials, preparations, and pyrometry are treated. It seems, therefore, that the book could more appropriately be styled *Electrochemistry*.

The experiments on heat of neutralization should have been multiplied, and the results discussed. Gas calorimetry, and the combustion of coal, might better be handled under fuel analysis, and some more important uses of the calorimeter be studied here. More space, relatively, is given to analysis than it deserves. The rotating cathode, page 66, Fig. 16, is crude and very inefficient. The comparison of decomposition voltage with boiling point, page 97, is far-fetched. The fact that mercury has a low solution tension but a high over-voltage for hydrogen seems to contradict the partial explanation offered for overvoltage, page 102. Under pyrometry, the very important base metal couples

are not considered. In practice, too, it will be found more satisfactory to take a series of melting points and construct the curve, in thermocouple calibrations, rather than calculate a constant from two points. It would also be better to describe an actual type of radiation pyrometer. Then, too, the sources of error in pyrometry should receive a little more attention.

While the book lacks arrangement, and contains several weak points, it is a step in the right direction. A laboratory manual for Electrochemistry is badly needed.

C. W. Bennett

*Monumentales und dekoratives Pastell.* By Wilhelm Ostwald. 12 X 17 cm; pp. 105. Leipzig: Akademische Verlagsgesellschaft, 1912.—When people burned wood, the gases given off were carbon dioxide and water, neither of which had any destructive effect on paintings or on marble statues while the effect on bronze is an improvement artistically. When coal came into use, it meant sulphur dioxide in the air and then sulphuric acid, which latter is destructive to marble and bronze and is fatal to all fresco painting. Since the wide-spread use of coal does not extend back much over a century, at any rate outside of England, it is evident that the experience of preceding centuries as to the permanency of works of art is absolutely worthless in regard to the problems which we have to face.

Ostwald set himself the problem of working out a process which would be applicable to the new conditions and he has apparently found it, where one would least expect it, in a modified form of pastel. When painting on canvas, the canvas is stiffened with glue and the glue made insoluble with aluminum acetate solution. A rough ground is provided by means of glue and pumice and on this one sketches with colored crayons which one prepares oneself. To fix the picture it is sprayed with a 2 percent solution of caseine containing some borax and a little alcohol. Care must be taken that no drops form and run down. The caseine is then made insoluble by means of a dilute formaldehyde solution or by means of an aluminum acetate solution. If the painting is to be exposed to the weather, it is probably desirable to go over it with a piece of solid paraffin. It is claimed that a painter using this process can finish a picture in one-fifth to one-tenth of the time ordinarily required.

In this volume Ostwald reprints his original article (1909) on the new technique. Then he gives a couple of reports from painters who have used the process. The last eighty-five pages are devoted to a detailed account of the new technique, including directions as to the way to prepare the ground, as to the best color to use, and as to the methods of painting, fixing and paraffining. Ostwald makes out a very strong case for his new method. There are now pictures by this method in the University of Jena, in a school at Weissensee near Berlin, in the Church of the Redeemer at Mannheim, and on the outside of a house in Schaffhausen.

Wilder D. Bancroft

*Beiträge zur Technologie der Seife auf kolloidchemischer Grundlage, I.* By J. Leimdorfer. 16 X 23 cm; pp. 56. Dresden: Theodor Steinkopff, 1911. Price: paper, 1.80 marks.—As the title shows, this is an attempt to study soap-making as a branch of colloid chemistry. This is the only possible way to treat the subject satisfactorily. The author believes that the reason one does not

add all the alkali at once, when making soap, is that the soap would then be precipitated as a hard curd as fast as formed whereas now it remains in a more jelly-like form and has the power of adsorbing alkali and undecomposed fat, thereby making them react more readily and more rapidly. While this is very likely true, it would have been more satisfactory if the author had given some independent proof of it. We know that the inversion of sugar by acids takes place in an agar agar jelly at practically the same rate as when the agar-agar is not there. This does not disprove the author's contention because there is probably very little adsorption of sugar or acid by the films of agar-agar; but it would be a good thing if we knew definitely that the two cases were quite distinct. While the author is undoubtedly on the right track, there is a certain vagueness about his way of wording things which makes one wonder whether he is really clear in his own mind in regard to details. One has the feeling that he has a good point of view; but that he has not worked it out carefully and that he is ~~passing gracefully but quickly over thin ice in a good many places.~~ We can put this in a somewhat different manner by asking how many people could read this pamphlet and then pass an examination set by an unfriendly critic.

This may seem a little unkind; but it is because the author is doing such good work that one would like to see him do better. There is no question but that we are going to have a tremendous scientific development along the lines of the application of colloid chemistry to technical processes; but it may be better policy to call attention to the things that we do not yet understand rather than to claim to have explained a great deal more than we really have. Of course there are times when it is wise to claim everything in sight; but there are also other times. The reviewer welcomes this pamphlet as a distinct step in the right direction; but he would have liked either to have seen the same ground covered a great deal more in detail or to have seen a clear statement of what we do not know.

Wilder D. Bancroft

**Galvanostegie, II.** By M. Schlöter. (*Monographie über angewandte Elektrochemie. XL Band*). 17 × 24 cm; pp. x + 190. Halle: Wilhelm Knapp, 1911. Price: paper, 12 marks.—The first volume (16, 258) dealt with the electrolytic deposits and the baths from which they were to be precipitated. This volume treats of the mechanical side and of the special arrangements necessary for handling a large volume of work in the shortest possible time. Thus the author takes up: cleaning baths; methods of moving electrodes or electrolyte; heating the electrolyte; methods of plating large numbers of small articles; plating sheets, tubes and wires; plating fabrics. These are all matters of great importance to the man who is engaged in electroplating because it is here that he is going to decrease or increase his costs. There is no question of chemical theory involved and consequently the volume will probably appeal more to the technical man than to the teacher, though there is no good and sufficient reason, except lack of time and of knowledge, why the teacher should lay stress only on the theoretical side of the subject.

W. D. B.

## THE THEORY OF EMULSIFICATION. II

BY WILDER D. BANCROFT

In the first paper<sup>1</sup> I discussed what little was known in regard to general theory. In this paper I propose to give an account of what is known in regard to the experimental preparation of emulsions, excluding the work of Pickering and of Robertson as well as the pharmaceutical side of the subject which will be taken up later.

Schischkoff has done some work on emulsions; but I have never seen the original paper and I therefore quote an abstract of it.<sup>2</sup>

"Adopting the view that milk is an emulsion of fat, the author has made attempts to emulsify different fats. A weak solution of potassium or sodium carbonate (0.4 percent) will only emulsify those fats which contain free fatty acid, even though in minute quantity. The richer the fat is in solid constituents, the more easily it is emulsified; fats poorer in solids require a larger proportion of free fatty acids. A fat must, however, be liquefied before it can form an emulsion; the case with which it does so depends therefore not on its firmness at ordinary temperatures, but on the superior attraction exerted by the emulsifying liquid on a solid over a liquid fat. An alkaline solution emulsifies a fat, when its smallest particles exert a sufficient attraction on any one constituent of the fat, even though absolutely indifferent to the remainder. Thus, oil of turpentine, mineral oil, etc., may be easily emulsified if mixed with a little stearic acid. A fat which cannot be emulsified in an alkaline liquid will be so easily when a different fat has been previously emulsified in the same liquid. The fat extracted from cow's milk by a mixture of alcohol and ether contains a certain quantity of fatty acids, and hence easily forms an emulsion. Melted butter, which contains relatively little free acid and solid fat,

<sup>1</sup> Bancroft: Jour. Phys. Chem., 16, 177 (1912).

<sup>2</sup> Schischkoff: Jour. Chem. Soc., 38, 273 (1880).

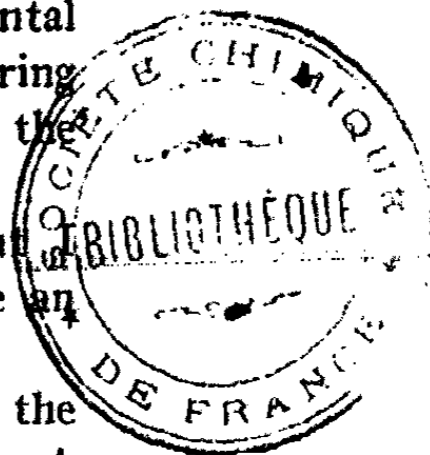

is emulsified with much less ease. The liquid part of butter is almost incapable of forming an emulsion, but does so easily when mixed with solid fat and a little free fatty acid. Conversely, cow fat completely loses its power of forming an emulsion after washing with a solution of an alkaline carbonate. It is singular that alkaline carbonates are chiefly attracted by, and combine with, the solid fats of butter. The author has not yet accurately determined what acids render milk fat emulsifiable: but among them are myristic, capric, caproic, and perhaps butyric acids, as may be concluded from some of the properties of their salts, and from their melting points. An emulsion may be pronounced good when it is brilliantly white, adheres strongly to glass, and on standing slowly separates a layer considerably thicker than the original fat. Under the microscope it appears to be formed of small globules, nearly uniform in size.

"The formation of an emulsion thus evidently depends on the division of the fat into minute globules, and the fixation of the emulsifying liquid on their surface by the molecular attraction exerted upon it by one of their constituents. The greater this attraction, the smaller will be the globules, but the more instable the emulsion. Shaking favors the division of the globules, and therefore the decomposition of the emulsion. The most permanent emulsions are furnished by fats containing fatty acids which do not easily combine with alkaline, since the alkaline salts of fatty acids attract fats but feebly. By prolonged shaking, an emulsion is completely decomposed into fat and soap, which do not further act on each other.

"Intermediate products are obtained by partial decomposition. An emulsion is decomposed on keeping, by cooling, and by dilution with water, alcohol, or ether, and by such operations as hasten saponification, *viz.*, heating, addition of strong alkali, etc. Albuminous matters added in excess decompose it very easily, forming soap-like compounds containing fatty acids, fat, albumin, and alkalis, or even salts. These compounds have little attraction for the excess



of fat, wherefore the latter separates. The fat contained in these compounds cannot be extracted by alcohol or ether alone, but may be so by a mixture of the two. Albuminous matters decompose emulsions less easily in presence of calcium, since a mixture of albumin with these salts, especially the phosphates, strongly attracts fats.

"That milk is an emulsion of fat in a liquid containing albumin, salts, and sugar, the author has proved by preparing a similar artificial emulsion closely resembling it. The changes taking place in milk when kept depend on the formation of various new emulsions. The composition of the cream is different at different periods of its formation. The first portions give the best butter, and consist of fat, alkaline phosphates, and albumin, forming a compound insoluble in water and weak acids; the later portions are richer in albumin and lime salts. These latter emulsions consist of smaller globules, contain free fatty acid, and yield a much coarser butter. About the time of their separation the milk begins to turn sour, and consequently all the substances which are insoluble in weak acids, and have a sufficiently low specific gravity, pass into the cream. If the souring of the milk be prevented, very little cream will be formed. Butter consists of fat, and an emulsion containing lime, insoluble in water.

"Finally, the author has discovered in whey an albuminoid which is different from common albumin and from casein. Synthetic experiments have shown that casein without albumin may form milk, but not cream. These two albuminoids together go to form milk and cream; but the latter is only obtained in its natural form, when the third modification is present."

This abstract contains a puzzling mixture of statements which are evidently true and of others which are apparently not true. The emulsification of turpentine, mineral oil, etc., in presence of stearic acid is undoubtedly due to the formation of soap with the alkaline carbonate solution. Fats which are not easily saponified will not form emulsions



readily unless a fatty acid is added. It is not clear, however, what the author means by saying that "the most permanent emulsions are furnished by fats containing fatty acids which do not easily combine with alkalis, since the alkaline salts of fatty acids attract fats but feebly." It is certainly not true that an emulsion is more instable the smaller the drops and shaking, at any rate within limits, does not favor the decompositions. Since many soap emulsions decompose on standing, owing to the coagulation of the soap, it is possible that a very prolonged shaking might decompose the emulsion into fat and soap as the author says. An excessive saponification will of course destroy the emulsion because there will be nothing left to emulsify.

Rachford has published a paper entitled "The Influence of Bile on the Fat-splitting Properties of Pancreatic Juice" which is really a study of emulsions and which I therefore quote.<sup>1</sup>

"In 1870 E. v. Brucke<sup>2</sup> announced the fact that when rancid oil<sup>3</sup> is shaken with a solution of sodium carbonate and certain other alkaline fluids, an immediate emulsion results. He believed that the oil was broken into fine globules by the shaking and that the soap formed served to hold the emulsion by preventing the union of the oil globules.

"In 1878 Johannes Gad<sup>4</sup> called attention to the fact that when oil containing the proper percentage of fatty acid was placed on the surface of a carbonate of sodium solution a beautiful spontaneous emulsion resulted, and from this he held that neither shaking nor any other outside mechanical force was necessary to the formation of an emulsion, but that the chemical force developed by the soap formation was of itself sufficient under favorable circumstances to break the oil drops into the finest emulsion globules. There is but little room for doubt, I think, that Gad is right in this opinion.

<sup>1</sup> Rachford: *Jour. Physiology*, 12, 72 (1891).

<sup>2</sup> *Sitzungsber. Akad. Wiss. Wien*, 61, II, 362 (1875).

<sup>3</sup> By rancid oil is meant oil containing fatty acid.

<sup>4</sup> *Archiv. Anat. Physiol.*, 1878, 181.

In fact the only question which might arise is whether the force developed by the soap formation is not a physical (Quincke) rather than a chemical one. Gad also believed with Brucke that the soap formed had much to do with holding the emulsion, and this proposition is, I think, now everywhere accepted, although opinions differ widely as to the manner in which the soap acts in bringing about this result.

"I wish here to call attention to the method used by Gad in his study of spontaneous emulsion, since this method is the basis of the methods used by me in the study of the fat-splitting properties of pancreatic juice. A 0.25 percent carbonate of sodium solution is placed in a series of watch-glasses, and drops of oil containing different percentages of fatty acid are gently placed, by means of a pipette, on the surface of the fluid in the watch-glasses. The amount of spontaneous emulsion in the various glasses is carefully noted and compared, and in this way one can readily ascertain the percentage of fatty acid required to give the best emulsion.

"It must, of course, be remembered in this connection, that the percentage of fatty acid required to give the maximum amount of spontaneous emulsion will vary with other conditions: such as temperature, strength of soda solution, etc., and that therefore only experiments made under similar conditions can be compared. By this method Gad observed that under otherwise similar conditions a certain definite percentage of fatty acid must be present in oil to give the maximum amount of spontaneous emulsion. For example, he found that with a 0.25 percent carbonate of sodium solution at room temperature, about 5.5 percent of fatty acid was required, and that with increasing or diminishing percents of acid above or below 5.5 percent he got less and less emulsion, until finally there was no emulsion at all. A very little more or less than 5.5 percent of acid gave an incomplete emulsion. He found, therefore, that the limits of good spontaneous emulsibility were not only constant but also quite narrow, and upon these important facts depends the value of his method.

"We have in Gad's method a simple and accurate means of determining the proper percentages of fatty acid for giving the best spontaneous emulsion of any given oil under given conditions. After repeating the experiments of Gad and confirming his observations I devoted considerable time to the study of the influence of shaking and other outside mechanical means on the formation of emulsions.

"The oil used almost exclusively in my experiments was olive oil that had been neutralized by shaking for 2 hours with a saturated solution of barium hydrate at a temperature of 95° C and then pipetted and filtered. Oil freshly prepared in this manner will be found practically neutral, and the term neutral olive oil as used in this paper always refers to such oil.

"The stirring was done chiefly by currents of air carried from a blowing machine, into the liquids to be stirred by means of rubber tubing and glass rods. This method is not only more convenient but it has other advantages over the ordinary one of slaking the tube.

"My experiments led me to the following conclusions:

*First.*—No amount of stirring will give a permanent emulsion of either neutral olive oil or of rancid olive oil in distilled water. (Frey<sup>1</sup> found differently.)

*Second.*—No amount of stirring will give a permanent emulsion with neutral olive oil and a 0.25 percent carbonate of sodium solution.

*Third.*—Shaking rancid oil and a 0.25 percent carbonate of sodium solution gives a good permanent emulsion, even though the oil contain a very small or very large percentage of fatty acid.

"From the above observations we see that when the conditions for soap formation are present, shaking very much widens the range of good emulsibility and promotes the formation of a good permanent emulsion, but when the conditions for soap formation are not present, the shaking has no influence whatever.

<sup>1</sup> Archiv. Anat. Physiol., 1881, 382.

"In our study of emulsions we must remember that two things are necessary to the formation of a good, permanent emulsion.

*First.*—The oil must be broken into very fine globules.

*Second.*—These globules must not only be prevented from running together, but they must also remain rather uniformly distributed throughout the liquid. Now since we know that soap and certain other materials, as albumin and mucilage, have the power of holding emulsions, it would seem an easy matter to make a mechanical emulsion by shaking neutral oil in a solution of soap, albumin or mucilage; but such in truth is not the case. In my experiments with soap solution and neutral olive oil I found that in very heavy solutions of soap, by violent and prolonged stirring, I could get only an imperfect emulsion, one in which the oil globules were larger and more variable in size than those formed by spontaneous emulsion.

"These mechanical emulsions do not approach in perfection a physiological emulsion, such as milk; and they can be formed only in very viscous liquids and with such great mechanical force as to place them beyond the pale of physiological importance. For the study, therefore, of the influence of stirring in the formation of good permanent emulsions, such as may have some physiological importance, we must return to the experiments already noted, where a moderate amount of stirring very much hastened and promoted the formation of good emulsions when the conditions for soap formation were present.

"The influence of stirring under such circumstances may, I think, be explained as follows: When too little acid is present for the formation of a good spontaneous emulsion, the shaking or stirring simply favors the emulsion by promoting soap formation. It breaks the oil into a number of small globules which are constantly presenting new surfaces to the surrounding alkaline fluid, thus enabling the soda to combine with all the fatty acid present, in the formation of soap, and the chemical force thus liberated by the soap forma-

tion becomes an important factor in the breaking of the oil drops into the fine emulsion globules, just as it does in pure spontaneous emulsions.

"When too much acid is present for the good spontaneous emulsion, the process is brought to a standstill by the formation of a heavy soap membrane between the oil drop and the alkaline fluid, thus preventing further soap formation. Under these conditions, shaking breaks the oil drop and consequently the soap membrane, thus constantly presenting new surfaces of oil to the surrounding alkaline fluid and in that way favoring soap formation and the resulting emulsification. We see, therefore, that while shaking may play a very important role in the formation of emulsions, its action is chiefly an indirect one, promoting emulsification by favoring soap formation, and that the chemical force liberated by this process is the force most active in breaking the oil drops into fine emulsion globules. From my experiments I formulate the following general law concerning the influence of stirring in the formation of emulsions.

"The amount of stirring required to give a good emulsion of oil in a 0.25 percent carbonate of sodium solution will be in inverse proportion to the nearness with which the percentage of fatty acid in the oil approaches the proper percentage for giving the maximum amount of spontaneous emulsion. If the oil contains the exact percentage of fatty acid for giving the best spontaneous emulsion, then the shaking will be superfluous, since a good emulsion will form without motion and no amount of shaking can improve it. If, on the other hand, the oil be entirely free from fatty acid, then, as we have seen, no amount of shaking will give a good emulsion. Between these two extremes the above law applies, and shaking may contribute very largely to the formation of emulsions.

"In the application of the above principles we have a simple and convenient method of determining when an oil is practically free from fatty acid; *viz.*, shake it with a 0.25

percent solution of carbonate of sodium, and if there be no fatty acid present, the mixture rapidly clears.

By the same method we may tell when we have fatty acid free from admixture with oil; *viz.*, shake the fatty acid with the soda solution, and if oil be present we will have more or less milky whiteness, which is characteristic of emulsions; but if no oil be present, we will have a simple cloudiness due to the insoluble soap formed. From all that has been said, it follows as a logical conclusion that the energy required to make an oil emulsible will be in direct proportion to the stability of the oil molecule of the given oil. The more stable the oil molecule, the more energy required to split it into fatty acid and glycerine. It matters not whether the energy be in the form of heat or of organized ferments, bacteria, or of unorganized ferments as the fat-splitting ferment of the pancreas.

"During my experiments I found that heating neutral olive oil developed fatty acid and made it emulsible, and that if this heated oil be again neutralized it became non-emulsible, thus showing the emulsibility to be due to the acidity. I also found that the greater the heat and the longer applied, the more fatty acid was developed, so that boiled olive oil contained too much acid for good spontaneous emulsibility.

"It is an interesting fact that the acids freed by heating various oils seemed to have greater power in making them emulsible than a like quantity of oleic acid. This is especially true of castor oil. Castor oil is not made more emulsible by the addition of oleic acid, but after boiling, it may be emulsified by shaking it with sodium carbonate solution, but it never becomes spontaneously emulsible; this latter fact Gad called attention to and thought it due to the viscosity of this oil. The stability of the castor oil molecule is shown by the great heat required to develop sufficient fatty acid to give an emulsion. These facts seem to indicate that the fatty acids of an oil are the fatty acids best adapted for giving emulsibility to this particular oil.

"It is a physiological fact beyond dispute that the split-

ting of fats is a most important preliminary step in fat digestion. That the cooking of fats will develop in them fatty acid is therefore a fact of considerable physiological importance and one that, so far as I know has not previously been noticed.

"As I have previously intimated, it is my belief that the chemical force developed by soap formation is the chief factor in the formation of all physiological emulsions, that it plays quite as important a role in the formation of the emulsion as the soap does in holding it after it is formed.

"That soap has the property of holding emulsions is, I think, an undisputed fact, but the manner in which the soap acts is a question concerning which there has been much difference of opinion. In explanation of this difficult problem I wish modestly to express my belief in a theory of emulsions which is a modification of that offered by Gad. Gad believed that the fine globules of oil were coated as soon as formed, with insoluble soap particles which formed a protecting envelope that prevented the oil drops from running together. The modification which I offer is as follows: the chemical process of soap formation which breaks the oil into fine globules must develop considerable heat, this must necessarily have the effect of bringing a certain amount of otherwise insoluble soap into solution. This heat will necessarily be local and felt chiefly just at the point where the soap is formed, and all the surrounding liquid will be cooler. The soap therefore which is brought into solution by the heat either is precipitated a moment later on coming in contact with cooler parts of the liquid, or it causes increased viscosity in the liquid. We may therefore say that the heat is developed, the soap formed and dissolved and the oil broken by the same force in the same place and at the same time. By this mechanism the oil globules are, as soon as formed, coated with a liquid soap which a moment later hardens about them in the form of soap membranes. These soap membranes at the moment of their formation are not as capable of holding the globules as they are later, when, on cooling, they become

more resisting. If this theory be true, it would follow that an appreciable length of time must elapse after the formation of an emulsion before it reaches its highest degree of stability. And this in fact I find to be true, that the emulsions can be more easily destroyed at the moment of their formation than later, and it is only in explanation of this and other facts that the above theory is offered. The following conclusions I draw from my experiments, and some of them are best explained by this theory.

*First.*—If bile be present an emulsion cannot form, although all the conditions otherwise favorable to its formation be present. This fact was pointed out by Gad, and he offered in explanation that the soap-dissolving properties of the bile prevented the formation of insoluble soap membranes, and that the unprotected oil globules ran together and came to the surface as free oil.

*Second.*—If bile is added to an emulsion, the moment after it is formed the emulsion rapidly clears by creaming, but no free oil appears on the surface. Here it seems that the soap not in membranes is dissolved. This increases the specific gravity and diminishes the viscosity of the liquid, and as a result the soap-coated globules rise to the surface as cream; why it is that the soap in the membranes more quickly acquires the property of resisting the solvent action of bile than the soap not in the membranes I cannot say, yet this seems the only explanation of the above phenomenon.

*Third.*—If bile be added to an emulsion some minutes after it has formed, it has no effect in destroying the emulsions. The above propositions clearly indicate that an appreciable length of time must elapse after the formation of an emulsion before it reaches its highest degree of stability.

*Fourth.*—One-tenth percent nitric and sulphuric acid and one-fifth percent lactic acid solutions rapidly destroy emulsions, the free oil running to the surface. Acids destroy emulsions by combining with the base of soaps and freeing the fatty acids; the soap being thus destroyed, the liquid is much less viscous while the specific gravity is very little altered.



The oil globules are therefore driven to the surface as cream, but if the acid be stronger, the soap in membrane is also destroyed, and free oil floats on the surface. The membrane soap is here found to be more resisting to soap destroyers than soap not in membranes.

*Fifth.*—Hydrochloric acid has a much less destructive influence on emulsions than has nitric or sulphuric acid, and lactic acid has a less destructive influence than acetic.

*Sixth.*—If *Sapo medicatus*<sup>1</sup> be shaken in a 0.1 percent nitric or sulphuric acid solution the soda of the soap will combine with the nitric or sulphuric acid, and fine globules of free fatty acid will rise to the surface. *Sapo medicatus* is more easily destroyed by nitric and sulphuric acids than it is by hydrochloric acid. These facts strongly corroborate the opinion that acids destroy emulsions by destroying soaps.

#### The Fat-splitting Properties of Pancreatic Juice

“Since the publications<sup>2</sup> of Claude Bernard, physiologists have generally believed that pancreatic juice has the property of splitting neutral fats into fatty acid and glycerine. Claude Bernard believed that the pancreatic juice had a two-fold action on fats. In the first place, he said that when neutral oil and pancreatic juice were shaken together an instantaneous emulsion resulted. In the second place, that the prolonged action of pancreatic juice on neutral oil would develop fatty acid. He did not in any way associate these two processes and believed them to be due to entirely different properties of the juice, the emulsion being an instantaneous process and the fat splitting occurring only after considerable time. And these two processes are still described as separate and distinct properties of pancreatic juice in some of our most recent text books. But since the publications of Brucke and Gad, most German physiologists have associated these processes, believing that the emulsion was wholly due to the fatty

<sup>1</sup> A soda soap made with olive oil acids.

<sup>2</sup> *Comptes rendus*, 28; *Arch. général*, 1849; *Mémoire sur le Pancreas*, Paris, 1856.

acid which had been developed in the oil by the fat-splitting ferment and that the pancreatic juice contained no emulsion ferment; this opinion was a matter of inference from the works of Brucke, Gad and others, rather than from actual experiments with the juice itself. I have failed to find that any systematic work in this direction had been done with pancreatic juice since the days of Claude Bernard. Quite a number of attempts have been made, but the difficulties in obtaining a normal juice were so great that no extensive work has been done and no important fact added to our knowledge. But while almost no work has been done with the juice itself, an immense amount of work has been done with ~~pancreatic extracts and infusions made from the gland.~~ Physiologists have seemed to take for granted that, in studying the physiological properties of pancreatic juice, the juice itself offered no advantage over these extracts. In fact they seemed to believe from the great difficulty in obtaining a normal juice that the extracts were preferable, and our knowledge of the present day is based almost exclusively on experiments with the extracts, and but for the fact that they contain a fat-splitting ferment the time-honored opinion of Claude Bernard would have carried but little weight. For these reasons, therefore, a systematic investigation into the fat-splitting properties of the pancreatic juice seemed to offer a fertile field for work.

"Although in the beginning the obstacle of obtaining normal juice in sufficient quantities to prosecute this investigation seemed insurmountable, yet I was fortunate enough to hit upon a method by which I could readily obtain from the rabbit a normal juice in sufficient quantities for experimental purposes. The operation for temporary pancreatic fistula in the rabbit is easily and quickly done as follows. Make an abdominal incision in the linea alba two and one-half inches long. Bring the duodenum, which is readily found high up in the right hypochondriac region, through this opening, run down the gut to a point where the peritoneum binds it so closely that it will not come through

the opening, and just at this point will be found the pancreatic duct as it runs through a leaf of the pancreas to the small intestine. Resect two inches of the intestine at this point, leaving its mesenteric attachment, tie the cut ends of the intestine above and below and drop them in the cavity, bringing the resected portion through the abdominal wound. The abdominal wound is now partially closed by stitches, leaving only sufficient opening for the mesentery running to the resected gut. This resected gut is now laid open opposite the mesenteric attachment and spread out on the abdominal wall. The ends of the gut are clamped and its margins packed with absorbent cotton to prevent bleeding. Insert a small glass canula through the pancreatic papilla into the pancreatic duct and cover the exposed mucous membrane with absorbent cotton saturated with common salt solution. The flow of juice begins at once and continues from 4-6 hours. In this manner about 1 cc of juice uniform and powerful in physiological action may be collected. This operation is a modification of the Heidenhain permanent fistula operation<sup>1</sup> and has the advantage of being simple and uniformly successful.

"In my experiments I used the pancreatic juice of the rabbit, as it seemed quite impossible for me to obtain from the dog a normal juice in sufficient quantities for experimentation. The fat used was neutral olive oil.

"I worked for several weeks with very faulty methods before I hit upon the method which I afterwards used and which, I think, is admirably adapted to the study of the fat-splitting properties of pancreatic juice. The foundation-stone of the method is the spontaneous emulsion method of Gad. We have previously seen how by this method we may determine when an oil has the proper percentage of fatty acid, to give the best spontaneous emulsion under certain given conditions. After having established the conditions under which one can get a good emulsion with a certain percent (5.5) of fatty acid, it is evident that we can use this method

<sup>1</sup> Hermann: Handbuch der Physiologie, Bd. V.

for determining when an oil has this percentage of fatty acid, and since the completeness of the spontaneous emulsion will be in direct proportion to the nearness with which the quantity of fatty acid in the oil approaches this percentage, we have also a method of estimating the amount of increase of fatty acid in any oil by testing its spontaneous emulsibility from time to time. For example, let us suppose that we have a neutral oil in which fatty acid begins to develop, and that this process slowly continues until all the oil is changed into fatty acid and glycerine. If the test of spontaneous emulsibility be applied to such an oil by placing a drop of it from time to time on carbonate of sodium solution, we get at first no emulsion at all, and then with the development of some fatty acid a slight emulsion, then more and more with increasing quantities of acid until the maximum emulsion is reached, which indicates that about five and a half percent of acid has been developed. The emulsion then decreases with the further increase of acid until finally we get no spontaneous emulsion at all, which indicates about 12 percent of acid. Beyond this point the increase of acidity cannot be measured by spontaneous emulsion. But in this particular and under these circumstances the emulsion formed by shaking is of some value, for good emulsions may still be had in this way after too much acid has been developed for spontaneous emulsion. But the greater the amount of acid the more shaking is required to give a good emulsion, until finally when all the oil has been changed into fatty acid and glycerine we get no emulsion at all, but only a cloudiness due to the insoluble soap formed. In this method we have a simple means of approximately estimating the increase of the fatty acid in an oil and of determining when all the oil has been changed to acid and glycerine. This method is not used to determine the exact quantity of acid which an oil contains, but is used rather to make a comparative estimate of the amount of acid in the same oil at different times and in different oils at the same time.

"This method is applied to the study of the fat-splitting

properties of pancreatic juice in the following manner: Arrange a series of watch-glasses containing a 0.25 percent solution of carbonate of sodium. Take a small test tube of 2 cc capacity and place in it  $\frac{1}{3}$  cc of pancreatic juice and twice as much neutral olive oil. Shake the tube and allow the juice and oil to separate, then pipette a drop of oil from the surface and place it on the soda solution in watch-glass 1. Again, shake the tube and allow the oil and juice to separate, then pipette as before, placing a drop of oil in watch-glass 2. Again shake and pipette as before, and repeat this process every three or four minutes until the experiment is completed. The beginning of each experiment and the time of pipetting must be carefully noted. If the pipettings are three minutes apart, then the first drops of oil will have been exposed to the action of pancreatic juice three minutes, the second drop six minutes, the third drop nine minutes, and so on. By the amount of spontaneous emulsion occurring in these drops when placed on the soda solution one can comparatively estimate the quantity of fatty acid they contain. For example, in an experiment such as I have just narrated one may find very little emulsion in glass 1, more in 2, a fair emulsion in 3, good in 4, and the maximum in 5, and then the emulsion gradually decreases. By such experiments as this the fat-splitting properties of pancreatic juice can be beautifully demonstrated, and an idea formed of the rapidity of its action. There is a possible element of error in this method which had better be spoken of here. It would seem that the alkali of the pancreatic juice would combine with the fatty acids forming soap and in this way the oil would soon be emulsified in the juice itself and not separate after shaking. This would indeed be a serious drawback if it actually occurred, but in truth it does not occur until late in the experiment after we have obtained the information we sought by the spontaneous emulsion method. It is true that after a large quantity of acid has developed and by repeated shaking we get an emulsion of oil in the juice which somewhat interferes with the method. Although the sodium in the pancreatic

juice exists in the form of a carbonate, it seems to be peculiarly associated with some other substance which interferes with its combining with fatty acid in the formation of soaps. This may be illustrated by the following interesting experiment. Place in a small test tube drawn out like a pipette equal quantities of pancreatic juice and neutral olive oil, 0.5 cc each. Shake the tube and set aside for 24 hours. At the expiration of this time break the pipette point and allow the contents of the tube to escape slowly through the opening thus formed in the bottom of the tube. The pancreatic juice, being at the bottom, is the first to escape, and it is clear and strongly alkaline; then comes the oil which formed the upper layer, and it is strongly acid. Here we have a rancid oil and an alkaline fluid in contact for 24 hours with very little soap formation. This experiment clearly indicates that something interferes with the formation of soap from the alkalies of the pancreatic juice. This is a plausible explanation of why the element of error caused by soap formation does not interfere with the practical application of the method. But even the small element of error which is introduced by soap formation may be reduced to a minimum by using small quantities of juice and three or four times as much oil, and in that way the quantity of soda is gently reduced and the action of the juice is but slightly retarded. This latter seems a strange statement, yet I have found in my experiments that within the limits named, the same quantity of juice splits large quantities of oil almost as readily as small. In passing, let me again call attention to the experiment above narrated as a simple and striking lecture experiment. The alkalinity of the juice and the acidity of the oil as it follows through the same opening may be demonstrated by litmus paper or solution. With these details as to method we are prepared to consider pancreatic juice and its action on neutral fats.

*First.*—The pancreatic juice of the rabbit is alkaline and remains so for some time after it is removed. On two occasions I tested juice that had stood exposed at room tem-

perature for 24 hours and found it alkaline and physiologically active. Different specimens of pancreatic juice may vary in physiological activity. As a rule, the juice obtained from a fistula that has been acting several hours is not as active as juice from the same fistula obtained soon after the operation.

*Second.*--If pancreatic juice be shaken with neutral olive oil, the oil rapidly takes on an acid reaction. That this acidity is due to fatty acid is shown by the facts that all the acid may be extracted with ether and the oil made emulsible by its presence. The gradual yet rapid development of fatty acid by the action of pancreatic juice on neutral olive oil may be beautifully demonstrated by pipetting drops of oil at intervals from the surface of a mixture of pancreatic juice and neutral olive oil and placing them on a 0.25 percent solution of carbonate of sodium in a series of watch-glasses. Soon we have a slight emulsion, then more and more until the maximum is reached, then the amount of emulsion becomes less and less as too much fatty acid is developed, until finally we have no spontaneous emulsion at all. That an excess of fatty acid is the cause of the decrease and cessation of spontaneous emulsion may be demonstrated as follows. Take a drop of oil from a mixture of oil and pancreatic juice after it has passed the litmus of spontaneous emulsibility and mix it with neutral olive oil, and the mixture is spontaneously emulsible. In one experiment, for example, I took one drop of oil that had passed the stage of spontaneous emulsibility and mixed it with four drops of neutral olive oil, and one drop of the mixture on soda solution gave a beautiful spontaneous emulsion. Here one drop of the oil acted on by the juice contained sufficient fatty acid to make five drops of oil spontaneously emulsible, that is, to give five drops of oil about 5.5 percent of fatty acid. The drop of oil acted on by the juice must therefore have contained about 30 percent of fatty acid and the time required to develop it was thirty-five minutes. Since 30 percent of acid is so quickly developed, it seems a fair inference that the prolonged action

of the juice would change all the oil into fatty acid and glycerine, and such in fact is found to be the case.

*Third.*—All the oil is split into fatty acid and glycerine by from 1-2 hours' action of the pancreatic juice—time varies with the specimen of the juice. This may be shown by pipetting such fatty matter from the surface of the juice and shaking it with soda solution and no emulsion will result, simply a little clouding such as occurs when fatty acid is shaken with soda solution. But if one drop of this same fatty matter be mixed with six or eight drops of neutral olive oil, this mixture will, on being shaken with soda solution, give a good emulsion. This experiment is best performed by adding a small quantity of bile to the juice before adding the oil. The bile does not interfere with the fat-splitting action of the juice, but it does interfere with the formation of an emulsion, and for that reason the oil and juice continue to separate after shaking.

*Fourth.*—The time required for pancreatic juice, acting in glass tubes at room temperature, to develop sufficient fatty acid (5.5 percent), in neutral olive oil to give the maximum spontaneous emulsion varies with different specimens of the juice and with the amount of shaking to which the juice and oil are subjected, but the average time as taken from my experiments was twenty minutes. In very active specimens of the juice it occurred as early as seven minutes, and in very poor specimens as late as sixty minutes. I also found that the juice did not act more rapidly in a basin of intestine than in the test tubes. In these experiments the resected intestine containing the pancreatic papilla was held by a fenestrated quadrilateral clamp made for the purpose, and into the basin of the intestine thus formed the pancreatic juice would ooze. Neutral olive oil was dropped into this basin and mixed with the pancreatic juice, and this oil did not become spontaneously emulsible more quickly than the oil in the test tubes, but the conditions here are also far from resembling those occurring in the normal duodenum, and the average rate of fat-splitting as established by these experi-



ments is probably considerably below the rate at which fats are split in the duodenum. It is probable that the time required by the most active juice more nearly represents the rapidity of action of pancreatic juice in the duodenum.

*Fifth.*—The action of pancreatic juice on most of the fats is rapid and complete. Castor oil is a notable exception to this rule, as only a very small quantity of acid is developed in it by the action of pancreatic juice for 5 hours at 37° C. Castor oil is therefore practically indigestible and this may in part account for its cathartic action. Pancreatic juice acts slowly on fats which have a melting point above body temperature, but it is an interesting physiological fact that their solidity at body temperature does not prevent their being split. Spermaceti for example, the melting point of which is above 38° C, is slowly split by the action of the pancreatic juice.

*Sixth.*—As I have previously said, the pancreatic juice of the rabbit and neutral olive oil when shaken together show very slight tendency to the formation of an emulsion, and it is only after considerable acid has developed that repeated shaking will give a mixture resembling an imperfect emulsion. But if we mix and shake at intervals one part of neutral olive oil and one part of pancreatic juice for about fifteen minutes, and then add six parts of soda solution, we get at once an apparently good emulsion. This emulsion does not remain good; it always, in the course of an hour or two, clears by creaming, when the whole mixture will be found to have a strong acid reaction due to the large quantity of fatty acid developed. Whatever may be the explanation of the clearing of this pancreatic emulsion, the fact remains that an emulsion will form in the presence of pancreatic juice if carbonate of sodium solution be added, but it does not remain permanent.

*Seventh.*—A permanent emulsion may be formed by pipetting the oil from the surface of a tube containing oil and juice and shaking it with the carbonate of sodium solution. The emulsion formed in this way remains very much the same for an indefinite length of time. In this experiment the oil is

made emulsible by the action of the juice and is then separated from it and emulsified with the soda solution; the emulsion itself contains no pancreatic juice and therefore does not clear. This permanent pancreatic emulsion reacts to emulsion-destroying agents and soap dissolvers very like a fatty acid emulsion made with rancid oil and sodium solution. For example, it is not destroyed by the addition of bile or fatty acids, but is destroyed by mineral acids, resisting hydrochloric better than nitric and sulphuric acids. The pancreatic emulsion also resembles the simple rancid oil emulsion in that an appreciable length of time must elapse after its formation before it reaches its greatest degree of stability. This may be demonstrated by adding bile in excess immediately after the formation of the emulsion, when it destroys the emulsion by creaming, but if the bile be added later no such effect is produced. It also resembles the rancid oil emulsion in that it cannot form at all in the presence of bile.

"The most important application of the method I have described is in obtaining comparative information concerning the fat-splitting properties of pancreatic juice. This application of the method may best be explained by detailing an experiment inquiring into the difference in the rapidity of action of pancreatic juice at room ( $18^{\circ}\text{C}$ ) and at body temperature ( $37^{\circ}\text{C}$ ).

Arrange two rows of watch-glasses containing 0.25 percent carbonate of sodium solution. Take two small test tubes,  $\frac{1}{3}$  cc of the same pancreatic juice in each, and to each tube add  $\frac{1}{3}$  cc of neutral olive oil. Shake both tubes equally and place one of them (A) in a sand bath kept in an oven at  $37^{\circ}\text{C}$  and leave the other (B) at room temperature. At the expiration of three minutes pipette a drop of oil from A and place it in watch-glass 1, row 1; then as quickly as possible, with a clean pipette, take a drop from B and place it in watch-glass 1, row 2. Both tubes are shaken and replaced and at the expiration of three minutes a drop is again pipetted from the surface of each. That from A is placed in row 1, that from B in row 2. This process is repeated again and

again to the end of the experiment. At the close of the experiment it will be found that the emulsion occurs almost twice as quickly in row 1 as in row 2. The three-minute drop of oil from A gives as good an emulsion as the six-minute drop of oil from B, and the nine-minute drop of oil from A gives the same emulsion as the eighteen-minute drop of oil from B. Since these tubes were, apart from the temperature, treated as nearly alike as possible, we infer that pancreatic juice acts about twice as rapidly at 37° C as it does at 18° C. The average ratio of increased rapidity of action, taken from my experiments, was as one to one and eight-tenths.

~~Whatever objections may be urged against the absolute~~ accuracy of the figures obtained by this method, the same do not apply to the comparative accuracy of these figures. Even though we may not be able, by this method, to estimate the amount of acid produced by pancreatic juice in nine minutes acting at 37° C, we do know by this method, whatever this amount may be, that it requires one and eight-tenths times as long for pancreatic juice to produce the same amount at 18° C. In comparative experiments such as this it is not necessary or practicable to have an equal length of time between the pipettings, but it is important that the tubes should be shaken at as nearly the same time and pipetted at as nearly the same time as possible, so that the oil drops be compared by spontaneous emulsibility may have been exposed by the action of the juice for the same length of time, thus establishing the comparative accuracy of the results.

The great value and wide application of this method is seen in the study of the influence of bile and other agents on the fat-splitting action of pancreatic juice.

"Bile alone does not split fats. This seems a well established physiological fact, which may be confirmed by shaking neutral olive oil and bile in a test tube and pipetting the oil at intervals to the surface of a carbonate of sodium solution as in previous pancreatic experiments, when it will be found that oil shaken with bile for 24 hours does not become emulsible. The value of this method is here most conspicuous as

the emulsibility of the oil could not be tested in the presence of the bile, because the bile would prevent an emulsion even if the fatty acid had been developed. But in this method the oil is separated from the bile after they have been in contact 24 hours and its emulsibility tested, and in this point lies the great value, and wide application of the method, since the very agents such as bile and hydrochloric acid which have the greatest influence on the fat-splitting action of pancreatic juice are the agents which interfere with the formation of emulsions."

Perhaps one of the most interesting things in this paper, so far as the theory of emulsification is concerned, is the fact of there being a maximum of spontaneous emulsification. Unfortunately this did not appeal to the author at all and we know only that 5.5 percent fatty acid is the best when one adds a drop of oil to an unspecified amount of a 0.25 percent sodium carbonate solution, the concentration referring possibly but not probably to the anhydrous salt. It seems probable that the absolute amount of the carbonate solution would have an effect since the oil is to be emulsified in the whole of it. We are given no information on this point nor are we told anything about how the optimum value of fatty acid varies with varying concentration of the sodium carbonate. Since we do not know the volume of the sodium carbonate solution we have no way of telling whether there is alkali enough to neutralize all the fatty acid or not.

It is a common thing for people to speak of milk as a perfect emulsion; but the facts do not warrant this. Cream starts to rise almost at once and nobody would call a synthetic emulsion a success which went to pieces as quickly as milk does. By passing milk through a homogenizer and thus decreasing the size of the globules, man improves on nature very much so far as the stability of the emulsion is concerned.

The fact, noted by the author, that the protecting film becomes stronger and less soluble in the course of time is probably due to the same cause that makes many hydroxides,

sulphides, and other colloidal precipitates become less soluble on standing. People often attribute this to a polymerization; but there is no experimental justification for this and we are really dealing with an agglomeration.

The author's experiments do not warrant the far-reaching and somewhat improbable generalization that the particular mixture of acids arising from the decomposition of any given fat form the best possible mixture of soaps for emulsifying that particular fat. All he has shown is that under the conditions of his experiments, a mixture of fatty acids is better than oleic acid. Even this may not be true under slightly different conditions. I have seen an emulsion made with ordinary soap which looked better at the start than a corresponding one made with sodium oleate. The first one went to pieces inside of a few days while the oleate emulsion was practically unchanged at the end of a month.

Moore and Krumbholz<sup>1</sup> have published a paper "On the Relative Power of Various Forms of Proteid in Conserving Emulsions" which I quote.

"It is well known that proteid solutions possess to a certain extent the power of preventing the coalescence of fat globules in suspension, and hence delay the separation of emulsions.

"Pancreatic juice obtained from a permanent fistula has less emulsive power than that from a temporary fistula; the former is also poorer in proteids and it is probable that this may have something to do with the diminished action. In fact, Minkowski<sup>2</sup> has expressed the opinion that it is chiefly to the proteid that emulsion is due. According to Kühne<sup>3</sup> the emulsive power does not depend upon the alkali of the juice, for an emulsion can be obtained in a faintly acid solution. It has also recently been shown that very perfect emulsions may exist in the small intestines during fat digestion, in fluids of markedly acid reaction. But in such cases

<sup>1</sup> Proc. Physiol. Soc. London, 54 (1898).

<sup>2</sup> See Abelman: Inaug. Diss. Dorpat., 1890.

<sup>3</sup> Lehrbuch physiol. Chem., 122.

it was shown that soaps were also probably present in solution and that the acid reaction was due to weak organic acids.<sup>1</sup>

"So far as we are aware, no one has hitherto made any experiments to test how far this property is shared by proteid derivatives. We have experimented with solutions made from white of egg and blood serum, with alkali and acid albumin prepared from each of these, and with Witte's peptone, consisting chiefly of deutero-albumose.

"Solutions of one in five of white of egg and serum were made up by diluting with tap water. From these solutions the alkali albumins were made by heating with 1 percent of sodium carbonate, and the acid albumins by similarly heating with 0.2 percent in each case of hydrochloric and of sulphuric acids. The Witte's peptone was used in 5 percent solution. As controls there were used tap water, 1 percent solution of sodium carbonate, and 0.2 percent solutions of hydrochloric and of sulphuric acid.

"Ten cc of each of the above fluids were shaken in test tubes equally briskly in each case and for an equal length of time with 5 percent of olive oil (*i. e.*, 0.5 cc). Then the test tubes were allowed to settle and the appearance noted in each case. It was found that those tubes in which the oil had been shaken up with tap water or diluted acid cleared almost instantly. The solution of albumoses cleared in a few minutes, that of serum albumin within an hour, that of egg albumin became nearly clear in 3-4 hours. The solution of 1 percent sodium carbonate remained slightly clouded, but formed a marked contrast to the two solutions of alkali albumin from the white of egg and blood serum solutions, respectively, which remained quite opaque several days after. The solutions of acid albumin also retained a permanent emulsion and were still white and opaque at the end of a week. In these solutions the reaction was markedly acid.

"Although the native serum albumin does not possess as much retaining power as the native white of egg solution the derived albumins made from it are distinctly more powerful

<sup>1</sup> Moore and Rockwood: Jour. Physiology, 21, 74 (1897).

than those similarly prepared from white of egg. This is seen more distinctly at the end of 24 hours and later, than in the beginning of the experiment.

"The forms of proteid with which we have experimented may hence be arranged in the following ascending order with regard to their power of maintaining emulsions: albumose, serum, white of egg, acid and alkali albumin. In this series albumose is practically inert, serum and white of egg have scarcely any action, while both alkali and acid albumin are very effective. Alkali albumin is slightly better than acid albumin, but the difference is probably due to the independent ~~action of the alkali in forming soaps. At first, there is a~~ marked difference between the alkali and acid albumin, but this nearly all disappears as the time increases after the shaking.

"If a mineral acid, such as hydrochloric acid, be added to a solution of alkali albumin, holding olive oil in an emulsion, in sufficient amount to redissolve the precipitated alkali albumin, the emulsion is not thereby destroyed but persists even in strongly acid solution.

This experiment clearly shows that the precipitations of emulsions held in suspension by alkalies alone is not due to the solution becoming acid, but to the decomposition of the soaps, which are in that case the only agency for holding the fat globules in suspension. Similarly the fat globules are removed from milk by the addition of acid, because this precipitates the caseinogen which in the case of milk holds them in suspension; when the caseinogen is by any means dissolved again the fat globules once more pass into suspension, reforming an emulsion.

"It has been found by Abelman<sup>1</sup> that after pancreas extirpation, milk-fat is the only form of fat which continues to be absorbed, and Neumeister<sup>2</sup> attempts to explain this by an experiment which is intended to show that milk differs from other emulsions in its behavior towards acids.

<sup>1</sup> Inaug. Diss. Dorpat, 1890.

<sup>2</sup> Lehrbuch physiol. Chem., 335 (1897).

"Neumeister clotted milk by rennet and then dissolved the clot by the action of pepsin and hydrochloric acid. He found that the acid fluid so obtained formed a very permanent emulsion, which was not destroyed by making it alkaline, followed by the addition of acid. This experiment does not show, however, that milk is essentially different from other emulsions, in acid solution the emulsion is retained by acid albumin, in alkaline solution by alkali albumin (or dissolved acid albumin).

"The action of acid and alkali albumins in so maintaining emulsions, must be of service in the digestion and absorption of fats. Proteid food is invariably eaten along with fats, and as the fat becomes emulsified it will be maintained in a finely subdivided form by the action of the acid and alkali albumin simultaneously formed. The fat does not become much subdivided in the stomach, and hence the acid albumin formed here does not come much into action, but afterwards in the duodenum the alkali albumin present undoubtedly must aid in preserving the emulsion which is formed there."

Wurster<sup>1</sup> states that "in a dilute solution of rosin soap containing free rosin, the latter separates as an emulsion, but does not collect together even on boiling. In a concentrated solution, however, the liquid becomes yellow at a certain temperature and the free rosin is rapidly deposited in a flocculent state." This experiment would have to be repeated under more definite conditions before one could discuss it safely. Donath<sup>2</sup> has used the formation of an emulsion as a means of detecting adulteration. He boils a nut-sized piece of beeswax for five minutes with a concentrated solution of sodium carbonate. If an emulsion is formed which remains on cooling, the wax is adulterated with rosin, tallow, stearic acid or Japanese wax.

The general results of this paper are as follows:

(1) Oils containing 5.5 percent free fatty acid will emulsify spontaneously when added in drops to a 0.25 percent

<sup>1</sup> Jour. Chem. Soc., 34, 626 (1878).

<sup>2</sup> Ibid., 26, 194 (1873).



sodium carbonate solution. Spontaneous emulsification takes place less readily if the oil contains more or less free acid.

(2) It is probably not true that the mixture of acids formed by partial hydrolysis of any given fat is the best possible mixture for emulsifying that fat in a dilute sodium carbonate solution.

(3) The protecting soap films in an emulsion do not reach their maximum strength and insolubility instantaneously.

(4) While moderate shaking is advantageous in preparing an emulsion, it is possible that excessive shaking may be detrimental.

(5) Milk is not a perfect emulsion.

(6) Albumose has very little power of maintaining an oil emulsion; serum and white of egg have scarcely any action, while both alkali and acid albumin are very effective.

*Cornell University*

## EQUILIBRIUM IN SYSTEMS CONSISTING OF LEAD HALIDES AND PYRIDINE

BY GEORGE W. HEISE

The object of this work is to study the systems lead iodide-pyridine, lead chloride-pyridine and lead bromide-pyridine in the light of the phase rule.

A compound of lead iodide and pyridine has been described by Pincussohn,<sup>1</sup> while various compounds of pyridine with lead chloride and lead bromide have been prepared and analyzed by Pincussohn,<sup>1</sup> Classen and Zahorski,<sup>2</sup> Reitzenstein<sup>3</sup> and Goebbels.<sup>4</sup> However, no systematic quantitative study of the solubilities of these compounds in pyridine has hitherto been attempted.

The present article is really a part of a series of investigations on the equilibria in systems of various salts and pyridine, carried on in this laboratory under the direction of Professor Kahlenberg.<sup>5</sup>

### Equilibrium between Lead Iodide and Pyridine

The pyridine used was a purified (Merck) preparation, dried one week over fused caustic soda and then distilled. Only the fraction passing over between 114° C and 115° C under a barometric pressure of 742 mm. was employed. Lead iodide was prepared from pure lead nitrate (Merck) by precipitation from aqueous solution with pure potassium iodide. The lead iodide thus obtained was carefully washed with cold water, dissolved in boiling water and filtered hot. Pure lead iodide crystallized out on cooling. The supernatant liquid was then drained off, and the yellow flakes of lead iodide were dried, first between sheets of filter paper and

<sup>1</sup> *Zeit. anorg. Chem.*, **14**, 379 (1897).

<sup>2</sup> *Ibid.*, **4**, 101 (1893).

<sup>3</sup> *Ibid.*, **18**, 289 (1898).

<sup>4</sup> *Ber. chem. Ges. Berlin*, **28**, 794 (1895).

<sup>5</sup> *Jour. Phys. Chem.*, **12**, 283 (1908); **13**, 421 (1909); **14**, 189 (1910).

finally for several weeks in a vacuum desiccator. All of the work was done by diffused daylight or weak artificial light.

The solubility determinations were performed in a glass tube fitted with a glass stirrer. For determinations at or near room temperature, a large water bath was used as a thermostat. For determinations between room temperature and zero, the reaction tube was tightly fitted into one neck of a three-necked Wolff bottle. The temperature was kept constant by admitting a carefully regulated stream of ice water through a second neck, while an equal amount was drawn off through the third. Freezing mixtures of snow and salt were used from  $0^{\circ}$  down to  $-20^{\circ}$  C. For lower temperatures, solid carbon dioxide was necessary. For determinations above  $30^{\circ}$ , the reaction tube was carefully fitted into a large side-neck test tube provided with a reflux condenser. Boiling liquids in the outer tube kept the temperature constant. The following series of liquids was employed:

Liquid	Boiling point in degrees C
Ether	35
Carbon bisulphide	46
Acetone	57
Methyl alcohol	66
Ethyl alcohol	78
Water	100
Isobutyl alcohol	106

An oil bath was used as a source of heat in all determinations above  $100^{\circ}$  and also in securing temperatures lying between the boiling points of the substances above mentioned. Temperatures below  $-20^{\circ}$  were read on a toluene thermometer. An ordinary mercury thermometer served for higher temperatures.

In all cases the solvent was stirred with an excess of salt for 5 hours, to ensure saturation. After the stirring, the very finely divided solid was allowed to settle. This generally required at least an hour. The supernatant liquid was then siphoned directly into a weighing bottle. To hold back any

solid particles, the upper end of the siphon was carefully capped with a little cotton and muslin.

The solubility of lead iodide proved to be very slight and consequently the following procedure for determining the strength of the solutions was adopted: After the solution was weighed, the pyridine was carefully evaporated off over an oil bath heated to about 150°. The flask was thoroughly wiped, cooled and weighed. A number of blank tests with samples of known composition proved that this method yields satisfactory results.

All the results recorded in the following table are the average of a number of concordant readings and, judging from the corresponding curve (Fig. 1), they must be near the true values.

Equilibrium between saturated solution and solid  $\text{PbI}_2 \cdot 3\text{C}_5\text{H}_5\text{N}$

Temperature in degrees C	Grams $\text{PbI}_2$ in 100 grams of pyridine
— 43.5 Freezing point of saturated solution	—
— 37	0.166
— 28	0.168
— 20	0.175
— 9	0.186
0	0.200
+ 3	0.215
6 (transition point)	0.225

Equilibrium between saturated solution and solid  $\text{PbI}_2 \cdot 2\text{C}_5\text{H}_5\text{N}$

15	0.208
35	0.188
57	0.190
77	0.228
92	0.290
98	0.340
105	0.370
108	0.410
112	0.445

At  $-43.5^\circ$ , solid pyridine and salt separate out together; this is the freezing point of the saturated solution.

This temperature marks a quadruple point; the four phases of the non-variant system in equilibrium are: solid pyridine, solid salt, saturated solution and vapor. The solubility increases very gradually from  $-43.5^\circ$  to  $+6^\circ$ . Between these temperatures, the solid in equilibrium with the saturated solution is  $\text{PbI}_2 \cdot 3\text{C}_5\text{H}_5\text{N}$ . It appears as minute, white crystals which are fairly stable even at room temperature.

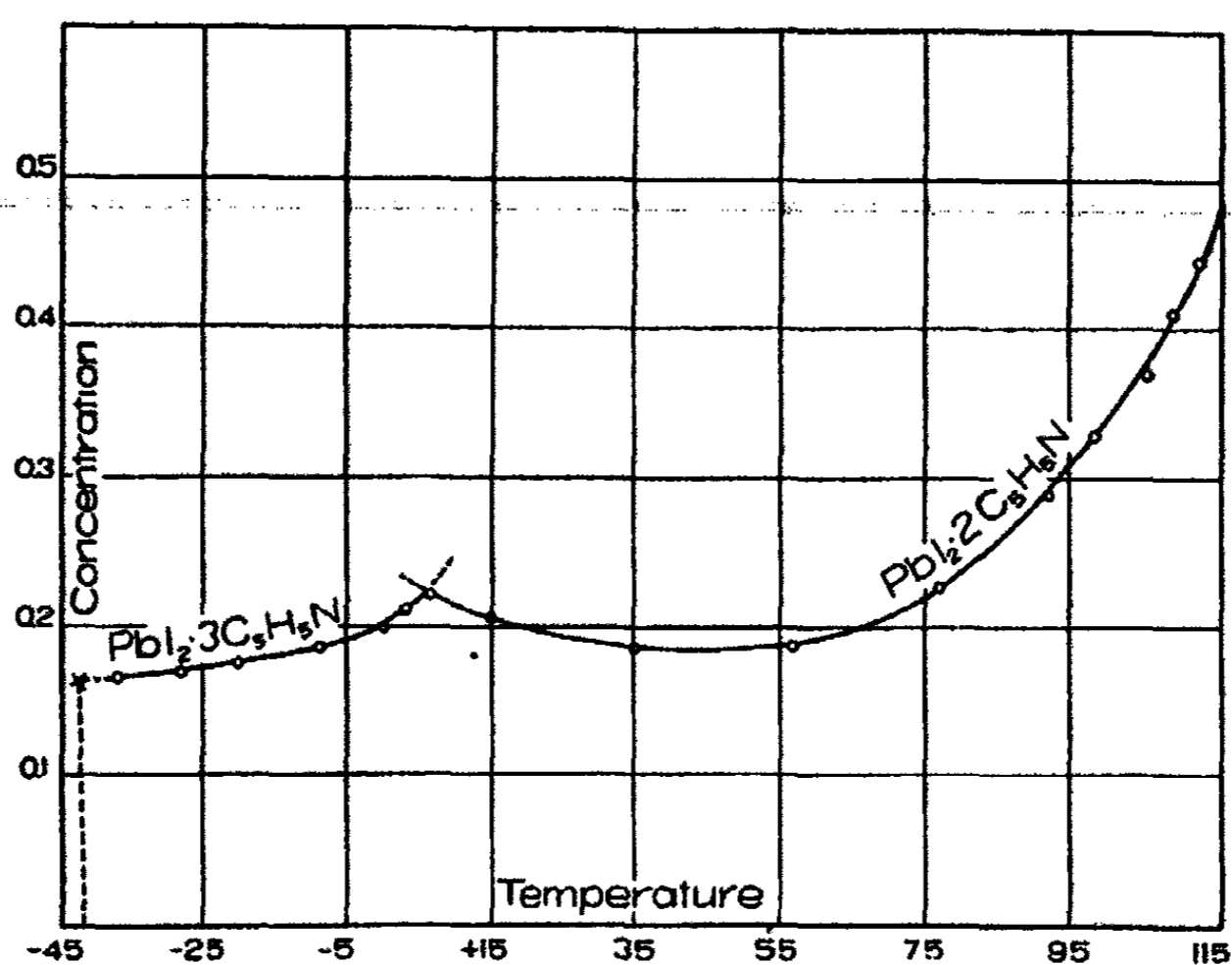

Fig. 1

Analysis of the solid showed 33.95 percent of pyridine, while the calculated amount in  $\text{PbI}_2 \cdot 3\text{C}_5\text{H}_5\text{N}$  is 33.96 percent. Though the solid forms a thick paste in pyridine, it can readily be dried on a porous plate.

Between  $6^\circ$  and  $65^\circ$  the solubility remains almost unchanged, but from  $65^\circ$  to the boiling point of pyridine it rises steadily. Between these temperatures, the solid in equilibrium with the saturated solution is  $\text{PbI}_2 \cdot 2\text{C}_5\text{H}_5\text{N}$ . It does not differ from the first-mentioned compound in appearance, having the same finely divided form and peculiar

chalk-white color. The particles were too small to enable any conclusions to be drawn concerning their crystalline structure. Upon analysis, the solid was found to contain 25.6 percent of pyridine, which coincides with the calculated value for  $\text{PbI}_2 \cdot 2\text{C}_5\text{H}_5\text{N}$ .

At 6° there is then a quadruple point at which vapor, saturated solution,  $\text{PbI}_2 \cdot 3\text{C}_5\text{H}_5\text{N}$  and  $\text{PbI}_2 \cdot 2\text{C}_5\text{H}_5\text{N}$  are in equilibrium.

In the work on lead chloride and lead bromide, the apparatus and method were the same as described for lead iodide. Both salts were made by precipitation from solutions of pure (Merck) lead nitrate by means of the corresponding potassium halide, and in each case the product was purified by recrystallization from hot water.

#### Equilibrium between Lead Chloride and Pyridine

The experimental results obtained in the case of lead chloride are given below. In each case, the reaction mixture was stirred at least 3 hours to ensure equilibrium in the system.

#### Equilibrium between saturated solution and solid $\text{PbCl}_2 \cdot 2\text{C}_5\text{H}_5\text{N}$

Temperature in degrees C	Grams $\text{PbCl}_2$ in 100 grams of pyridine
— 20	0.303
0	0.364
+ 22	0.459
44	0.559
65	0.758
76	0.893
90	1.07
94	1.12
102	1.31

The solubility rises more or less regularly with the temperature. As the curve (Fig. 2) indicates, there is but one solid in equilibrium with the solution. This solid has the composition  $\text{PbCl}_2 \cdot 2\text{C}_5\text{H}_5\text{N}$ , it separates out on cooling a hot, saturated solution in well-defined, needle-like crystals.

Analyses showed a pyridine content of from 33–35 percent, the calculated amount for  $\text{PbCl}_2 \cdot 2\text{C}_5\text{H}_5\text{N}$  being 36.2 percent. The compound loses pyridine very rapidly in air, a fact which makes it difficult to obtain concordant analyses and would account for the discrepancy between the calculated and the observed values.

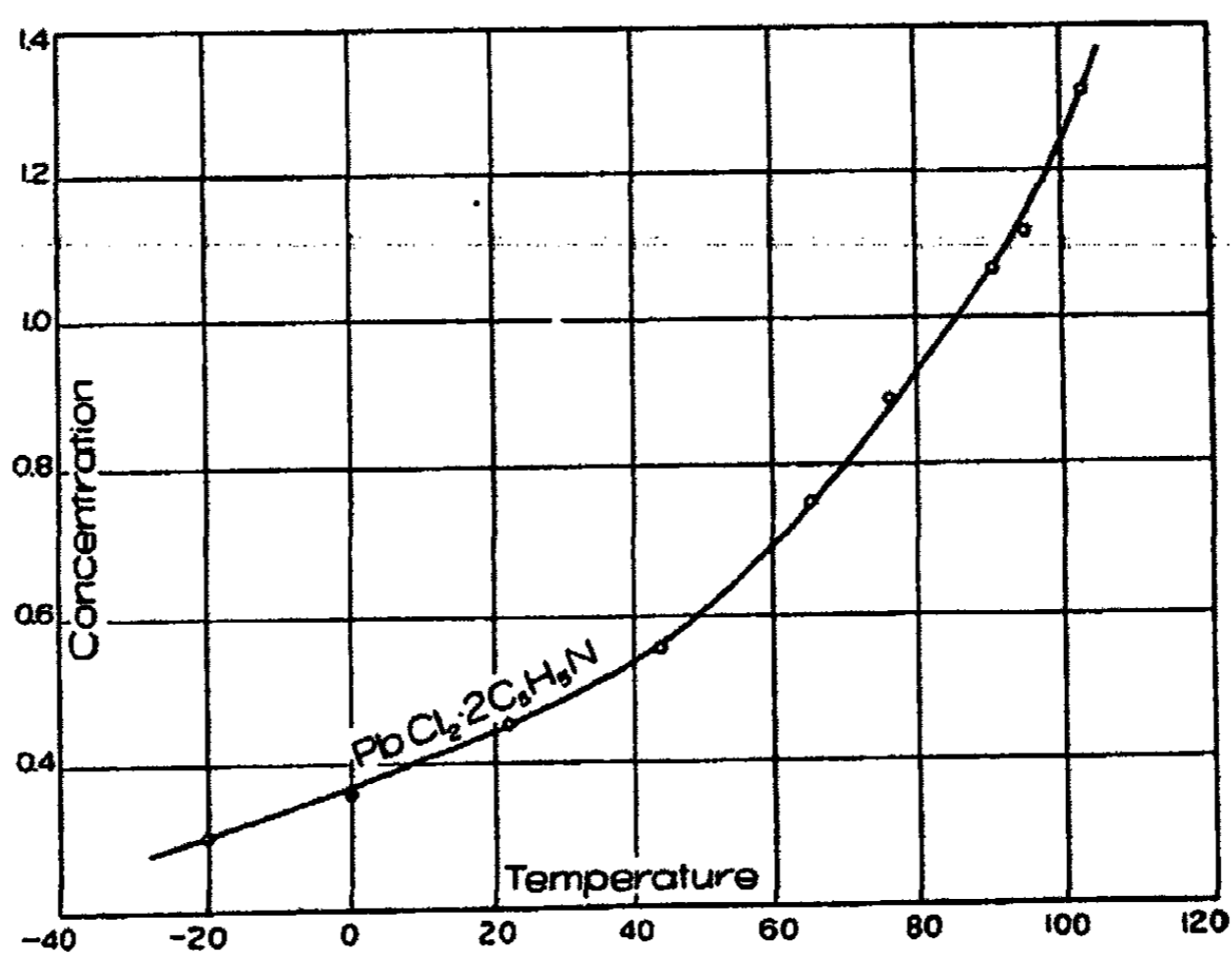

Fig. 2

There are three compounds of pyridine and lead chloride mentioned in the literature, *viz.*,  $\text{PbCl}_2 \cdot \text{C}_5\text{H}_5\text{N}$ ,<sup>1</sup>  $4\text{PbCl}_2 \cdot 3\text{C}_5\text{H}_5\text{N}$ <sup>1</sup> and  $3\text{PbCl}_2 \cdot \text{C}_5\text{H}_5\text{N}$ .<sup>2</sup> None of these has been found in the course of this work and their existence consequently seems very doubtful. It is possible that the fact that the compound,  $\text{PbCl}_2 \cdot 2\text{C}_5\text{H}_5\text{N}$ , decomposes very rapidly in air misled previous investigators, for none of them mentioned the temperature at which their work was conducted.

<sup>1</sup> Classen and Zahorski: *Loc. cit.*

<sup>2</sup> Reitzenstein: *Loc. cit.*

**Equilibrium between Lead Bromide and Pyridine**

For lead bromide the following results were obtained:

**Equilibrium between saturated solution and solid  $PbBr_2 \cdot 3C_5H_5N$**

Temperature in degrees C	Grams PbBr <sub>2</sub> in 100 grams of pyridine
-26	1.02
-10	0.89
-5	0.84
0	0.800
13	0.661
19 (transition point)	

**Equilibrium between saturated solution and solid  $PbBr_2 \cdot 2C_5H_5N$**

26	0.583
45	0.661
64	0.800
77	0.969
95	1.33
100	1.44
105	1.56

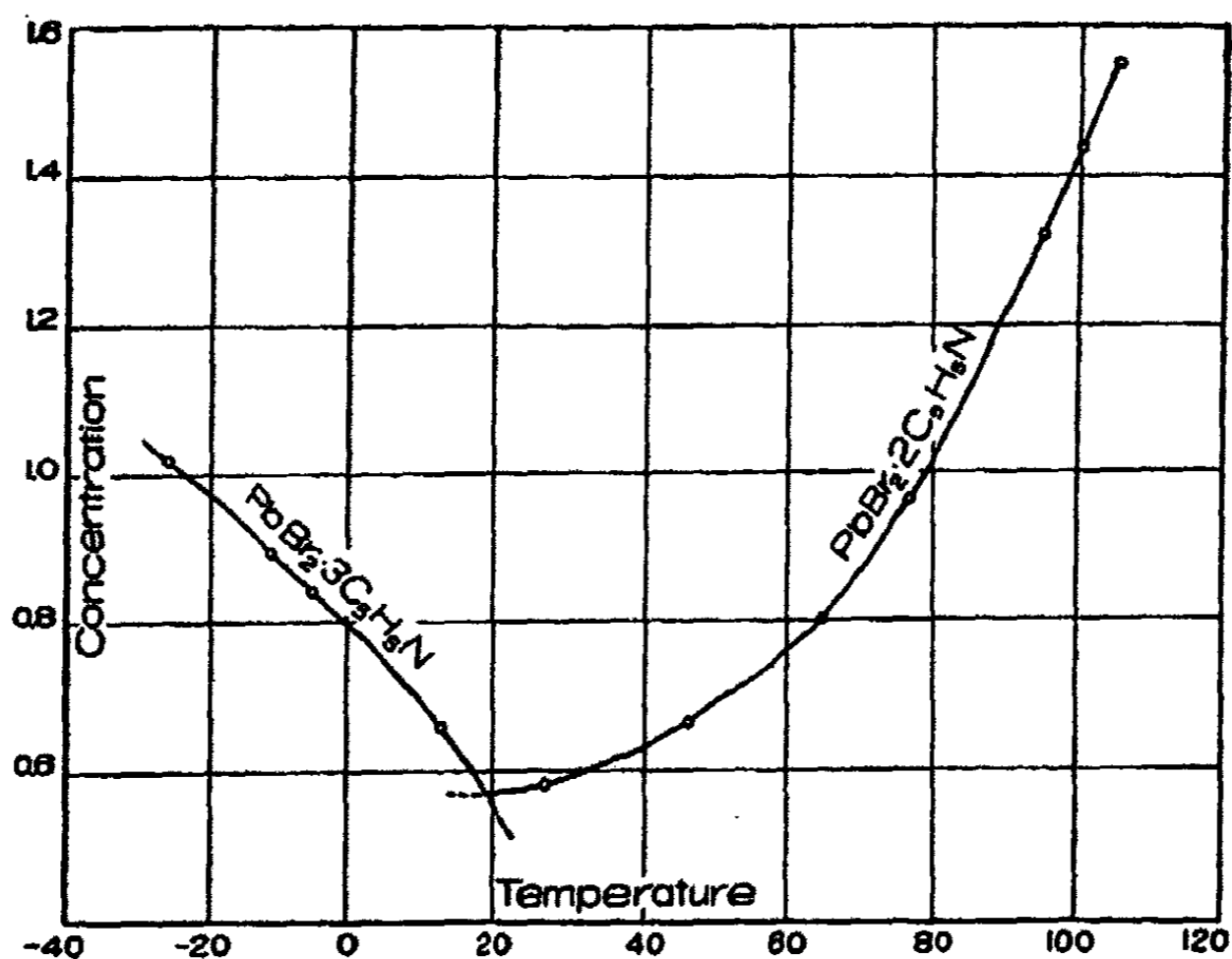

Fig. 3



As will be seen from the corresponding curve (Fig. 3), the solubility of lead bromide undergoes some rather remarkable changes with changes in temperature. Below  $19^{\circ}$ , the salt becomes less soluble with rise in temperature, the solid in equilibrium with the saturated solution being  $\text{PbBr}_2 \cdot 3\text{C}_5\text{H}_5\text{N}$ . On warming a saturated solution, the solid separates out in minute crystals, showing by analysis a pyridine content of 37 percent. The calculated amount of pyridine in  $\text{PbBr}_2 \cdot 3\text{C}_5\text{H}_5\text{N}$  is 39.2 percent. The discrepancy of 2.2 percent is probably due to the fact that the compound is exceedingly unstable, losing pyridine very rapidly in the air, even at temperatures  $30^{\circ}$  or more below the transition point.

Above  $19^{\circ}$ , the solubility rises rapidly until the boiling point of the saturated solution is reached. The solid in equilibrium with the solution is  $\text{PbBr}_2 \cdot 2\text{C}_5\text{H}_5\text{N}$ , analysis showing a pyridine content of from 28–30 percent. The calculated amount is 30.1 percent, and as this compound is also very unstable, the agreement is probably as good as could be expected.

At  $20^{\circ}$  there is a transition point at which  $\text{PbBr}_2 \cdot 3\text{C}_5\text{H}_5\text{N}$ ,  $\text{PbBr}_2 \cdot 2\text{C}_5\text{H}_5\text{N}$ , saturated solution and vapor are in equilibrium with each other.

Three compounds of lead bromide and pyridine have been mentioned previously, namely,  $\text{PbBr}_2 \cdot \text{C}_5\text{H}_5\text{N}$ ,<sup>1</sup>  $\text{PbBr}_2 \cdot 2\text{C}_5\text{H}_5\text{N}$ <sup>1</sup> and  $5\text{PbBr}_2 \cdot 7\text{C}_5\text{H}_5\text{N}$ .<sup>1</sup> But one of these compounds,  $\text{PbBr}_2 \cdot 2\text{C}_5\text{H}_5\text{N}$ , was actually found in this work. The fact that the compounds previously recorded show a smaller percentage of pyridine than those described in the present series of determinations would seem to point to the explanation that the investigators analyzed samples that had lost pyridine of crystallization.

#### Summary

In this work, the equilibrium between pyridine and halides of lead has been studied. Lead iodide forms two crystalline compounds with pyridine,  $\text{PbI}_2 \cdot 2\text{C}_5\text{H}_5\text{N}$  and  $\text{PbI}_2$ .

<sup>1</sup> Goebbels: Loc. cit.

$3\text{C}_5\text{H}_5\text{N}$ . The latter is stable below  $6^\circ$ , the former is the stable salt above that temperature. The crystals are minute in both cases. They are fairly stable and may be dried and analyzed very readily.

Lead chloride forms but one compound with pyridine,  $\text{PbCl}_2 \cdot 2\text{C}_5\text{H}_5\text{N}$ , within the range of temperature of the investigation, *i. e.*, from  $-20^\circ$  to  $+110^\circ$ . On cooling the saturated solution, the compound separates out in well-defined, needle-like crystals. In air, the crystals are exceedingly unstable, losing pyridine very rapidly.

Lead bromide forms two compounds with pyridine between  $-26^\circ$  and  $110^\circ$ ,  $\text{PbBr}_2 \cdot 3\text{C}_5\text{H}_5\text{N}$ , stable below  $19^\circ$ , and  $\text{PbBr}_2 \cdot 2\text{C}_5\text{H}_5\text{N}$ , stable above the latter temperature. In both cases, the crystals are small and extremely unstable. It is rather interesting to note that the solubility of lead bromide rises sharply as the temperature is lowered below the transition point.

Of the compounds mentioned above, the analyses of all but one,  $\text{PbBr}_2 \cdot 2\text{C}_5\text{H}_5\text{N}$ , are here reported for the first time.

My thanks are due to Professor Kahlenberg, at whose suggestion and under whose direction this work was done.

*Laboratory of Physical Chemistry,  
University of Wisconsin,  
Madison, March, 1912*

STUDIES IN THE ELECTROCHEMISTRY OF THE PROTEINS. VIII. THE DISSOCIATION OF SOLUTIONS OF THE SULPHATE AND CHLORIDE OF PROTAMIN (SALMIN)

BY T. BRAILSFORD ROBERTSON

(From the Rudolph Spreckels Physiological Laboratory of the University of California)

1. INTRODUCTION

In previous communications<sup>1</sup> it has been shown:

(1) That the caseinates and the serum globulins of the alkalies and of the alkaline earths obey the Ostwald dilution law for a binary electrolyte, expressed in the form:

$$m = \frac{1.037 \times 10^{-2}}{\rho(u+v)} x + \frac{1.075 \times 10^{-4}}{K\rho(u+v)^2} x^2 \dots \dots \dots (1)$$

where  $m$  = the equivalent concentration of the base neutralized by the protein,  $x$  = the conductivity of the solution in reciprocal ohms per cc at 30° C,  $\rho$  = the number of equivalents of protein salt to which one equivalent of neutralized base gives rise,  $u + v$  = the sum of the migration velocities, in cm per second per volt per cm potential full, of the ions into which the salt dissociates and  $K$  is the dissociation-constant of the salt.

(2) The salts which ovomucoid forms with sulphuric and hydrochloric acids obey the Ostwald dilution law for a tertiary electrolyte.

(3) Assuming the value of  $(u + v)$  to be approximately the same for all protein salts (since they dissociate only into heavy ions) the value of  $\rho$  for the caseinates and serum globulins of the alkaline earths is 1, while for the caseinates and serum globulins of the alkalies it is 2, and for the salts which serum globulin and ovomucoid form with acids it is 4.

<sup>1</sup> T. Brailsford Robertson: Jour. Phys. Chem., 11, 542 (1907); 12, 473 (1908); 14, 528, 601, 709 (1910); 15, 166, 179, 387, 521 (1911). "Die physikalische Chemie der Proteine," Dresden, 1912. Chapters 7-10.

These deductions have been confirmed by cryoscopic determinations.

(4) It appears highly probable that the salts of casein and serum globulin with the alkalis are formed and dissociate in accordance with an equation of the type:

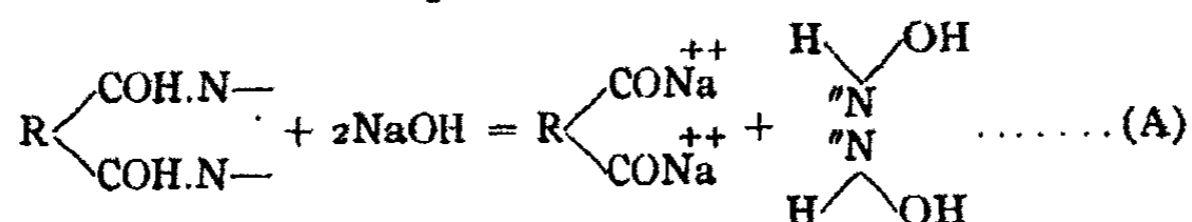

the two anionic radicles being united to form a single ion, while the salts of casein and serum globulin with the alkaline earths form and dissociate in accordance with an equation of the type:

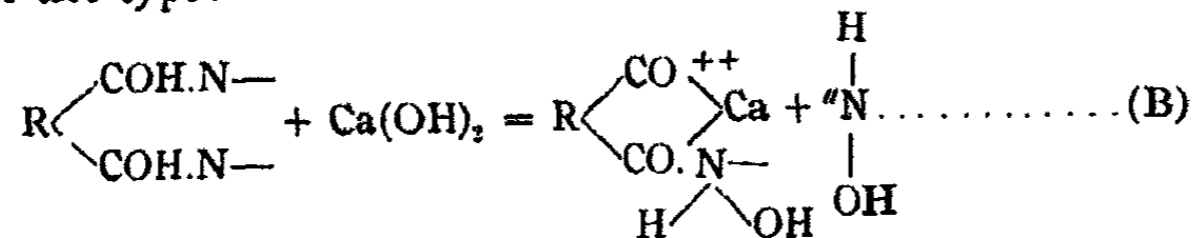

and the salts which ovomucoid forms with acids form and dissociate in accordance with equations of the types:

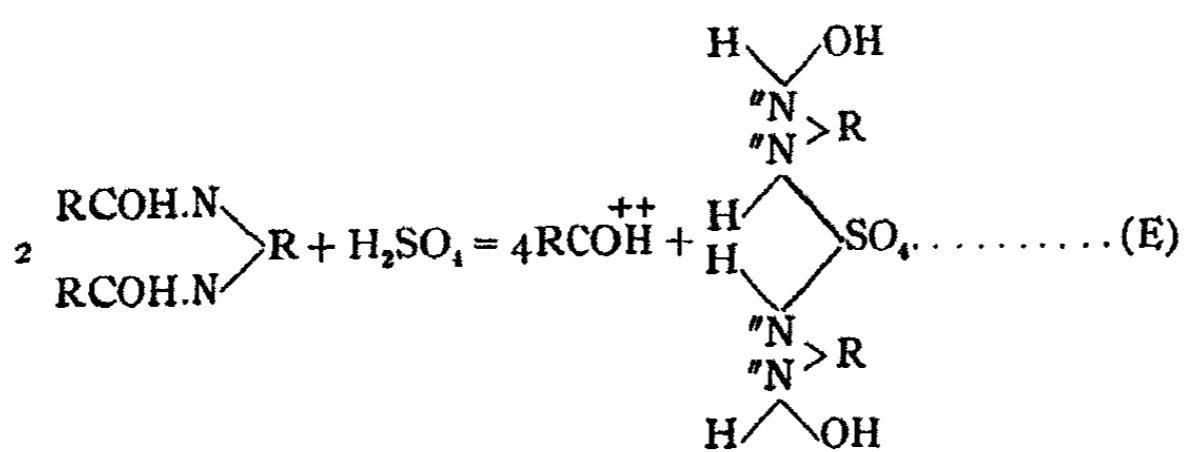
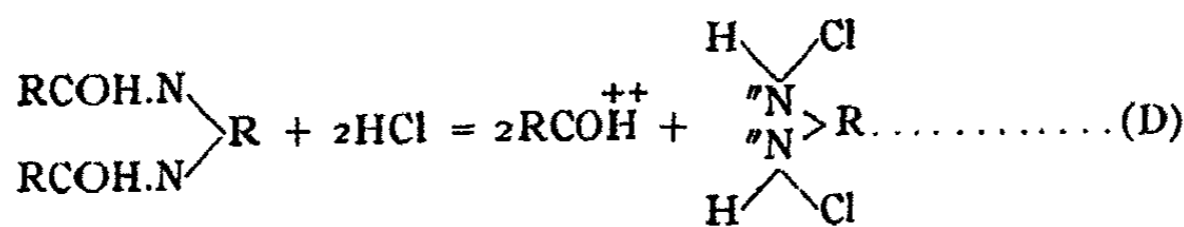
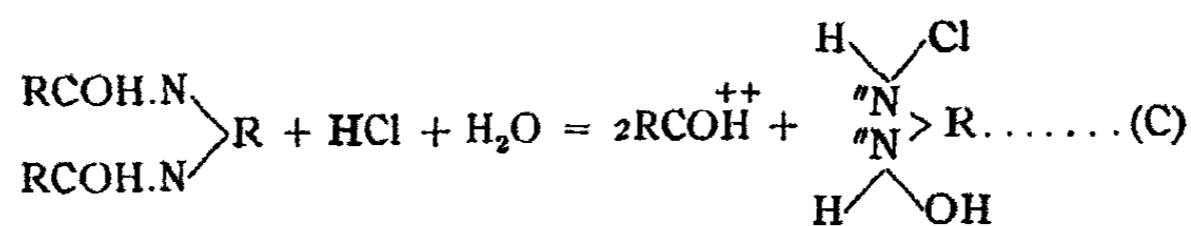

Of the proteins hitherto investigated electrochemically, casein and serum globulin are predominantly acid, while ovomucoid, although predominantly basic, is nevertheless not markedly so, its power to neutralize bases being only slightly less than its power to neutralize acids. It appeared of interest to determine the mode of formation and dissociation of the salts which its strikingly *basic* protein forms with acids; accordingly, the following investigations were undertaken.

## 2. EXPERIMENTAL

### (a) The Preparation of Salmin Sulphate

A member of the protamin group, namely salmin,<sup>1</sup> was prepared by the method of Kossel<sup>2</sup> as follows:

The ripe testicles of the Pacific salmon were minced and the macerated mass which was thus obtained was shaken up in tall glass cylinders with five or six times its volume of distilled water. The thick suspension of sperm which was thus obtained was syphoned off from the supernatant connective tissue and curdled by the addition of 80 cc per liter of *N*/10 acetic acid. The curdled mass of sperm was then washed in ten times its volume of 95 percent alcohol and this washing was repeated twice; it was then washed once in the same volume of absolute alcohol and then in the same volume of ether. The powder, wet with ether, which was thus obtained, was spread out upon filter paper to dry in the air in a warm, dry place.

Each 15 grams of the dried sperm was then stirred up in 350 cc of 1 percent by volume  $H_2SO_4$ , for about 6 hours. This mixture was then filtered through hardened filter paper and the filtrate obtained from the extraction of 15 grams of sperm was placed in a tall glass cylinder of about 4000 cc capacity which was then filtered with absolute alcohol. After allowing the precipitate to settle, the supernatant fluid was

<sup>1</sup> According to Taylor: Univ. of Calif. Publ. Pathol., 1, 7 (1904); the protamin which is contained in the sperm of the Pacific salmon is identical with the salmin found in the sperm of the European salmon.

<sup>2</sup> A. Kossel: Zeit. physiol. Chem., 25, 165 (1898).

syphoned off, the precipitate contained in two cylinders was collected in one and this was filled with alcohol again.<sup>1</sup> The entire precipitate, suspended in alcohol, from the extract of 300 grams of sperm, was dissolved by the addition of about 4 liters of hot water (about 80° C), the least soluble portion was filtered off, and the remainder reprecipitated by the addition of 10 volumes of alcohol. This precipitate was washed once in the same volume of alcohol as that employed in precipitation and then in a like volume of ether. The final suspension of protamin sulphate in ether, obtained after syphoning off the supernatant ether, was collected in a hardened filter, dried over sulphuric acid at 40° for 2 days and then pulverized and sifted. The product is a friable white powder. The yield from 300 grams of sperm was 14.6 grams.

The empirical formula of the substance which is thus obtained is, according to Kossel<sup>2</sup> and Taylor,<sup>2</sup>  $C_{39}H_{57}N_{17}O_6 \cdot 2H_2SO_4$ . It readily dissolves in water up to about 2 percent at 20°. It diffuses through parchment paper (Taylor). Its solutions are very faintly acid in reaction. According to Taylor the acidity of a  $\frac{1}{2}$  percent solution, measured by the gas-chain, is  $N/300$   $N H^+$ ; I found that 1 gram of my preparation in  $\frac{1}{4}$  percent solution required the addition of 9.6 cc of  $N/10$  KOH to render the solution just alkaline to rosolic acid, corresponding, in  $\frac{1}{2}$  percent solution, to an acidity of less than  $N/200$ ; since an acidity determined by titration in protein solutions must obviously be considerably in excess of the true acidity it may be inferred that the acidities of solutions of my preparation were not appreciably in excess of Taylor's estimate cited above. Since a 1 percent solution of protamin sulphate contains 0.0424 equivalent of  $H_2SO_4$  per liter, it is evident that protamin sulphate does not, in

<sup>1</sup> It is necessary to avoid washing with alcohol too frequently, as on suspending the protamin sulphate in alcohol for a third or fourth time a very stable suspension is produced from which protamin is only deposited very slowly.

<sup>2</sup> Loc. cit.

aqueous solution, undergo hydrolytic dissociation to any very appreciable extent. According to Taylor, a perfectly neutral preparation of protamin sulphate may be obtained by a special and lengthy process of preparation and purification.

#### (b) The Preparation of Salmin Chloride

Several attempts were made to prepare salmin carbonate according to the method recommended by Taylor,<sup>1</sup> in order to prepare the chloride from this substance. Many difficulties were found to attend this procedure, however. If excess of  $\text{Ba}(\text{OH})_2$  be added to a dilute solution of protamin sulphate great difficulty is encountered in removing this excess by means of  $\text{CO}_2$ , even at  $50^\circ \text{C}$ . After several hours' passage of  $\text{CO}_2$ , clear filtrates can be obtained which contain barium, a fact which is probably attributable to the formation of the barium salt of a carbamino derivative of the protamin.<sup>2</sup> Moreover, as Taylor points out, great difficulty is experienced in obtaining clear filtrates; indeed I have found the only successful method to consist in filtration under pressure through a Chamberland filter, a process which is attended by considerable loss of the protamin, since it is, to some extent, retained by the filter.<sup>3</sup>

Accordingly, salmin chloride was prepared directly from the sulphate in the following manner:

To a carefully weighed amount (1.48 grams) of protamin sulphate dissolved in 100 cc of water was added an exactly sufficient weight of carefully chosen barium chloride crystals, dissolved in about 20 cc of water, to precipitate the  $\text{H}_2\text{SO}_4$  in the protamin sulphate. This mixture was then set aside in a tall glass cylinder at  $50^\circ$  for 24 hours at the end of which time a compact precipitate of barium sulphate had settled to the bottom of the cylinder from which the clear supernatant fluid could readily be decanted. This fluid was filtered

<sup>1</sup> Loc. cit.

<sup>2</sup> Siegfried: *Ergeb. d. Physiol.*, 9, 334 (1910).

<sup>3</sup> This is true also of protamin chloride. A 1 percent solution of protamin chloride, after filtration through a porcelain filter under pressure, was found to be reduced in concentration to about  $\frac{1}{2}$  percent.

through a hardened filter and the protamin chloride precipitated by the addition of 5-6 volumes of absolute alcohol. After allowing the precipitate to settle the supernatant fluid was syphoned off and the precipitate washed in 1 liter of absolute alcohol and twice in 1 liter of ether (ueber Natrium destilliert), and was finally collected on a hardened filter and dried over  $H_2SO_4$  at  $36^\circ$  for 24 hours. It was then pulverized and sifted and dried for another 24 hours. The yield was only about a third of a gram, which is attributable to the fact that the precipitate, after washing in alcohol, only settled very incompletely—a phenomenon which appears to be characteristic of very anhydrous (or, as Taylor believes, very highly purified) preparations of salmin.

The empirical formula of this substance is, according to Kossel,  $C_{30}H_{37}N_{17}O_8 \cdot 4HCl$ . It dissolves readily in water yielding very faintly acid solutions.

**(c) The Conductivity Determinations**

The methods employed in the conductivity estimations were those which I have described fully elsewhere.<sup>1</sup> The resistance-capacity of the conductivity-vessel employed was 0.1949. The conductivity of the distilled water employed was  $3 \times 10^{-6}$  reciprocal ohms per cc at  $30^\circ$  C. The tabulated conductivities are the observed conductivities diminished by the conductivity of the distilled water.

The following were the results obtained :

TABLE I—SALMIN SULPHATE

Grams salmin sulphate in 100 cc. of solution	Equivalents of $H_2SO_4$ in a litre of solution	Conductivity of solution in reciprocal ohms per cc. at $30^\circ$ C
0.2500	0.01053	$758 \times 10^{-6}$
0.1250	0.00526	$441 \times 10^{-6}$
0.0625	0.00263	$250 \times 10^{-6}$
0.0313	0.00132	$137 \times 10^{-6}$
0.0156	0.00066	$74 \times 10^{-6}$
0.0078	0.00033	$38 \times 10^{-6}$

<sup>1</sup> T. Brailsford Robertson: Jour. Phys. Chem., 14, 528 (1910). "Die physikalische Chemie der Proteine," Dresden, 1912. Anhang.



TABLE II—SALMIN CHLORIDE

Grams salmin chloride in 100 cc of solu- tion	Equivalents of HCl in a litre of solution	Conductivity of solution in reciprocal ohms per cc. at 30° C
0.1250	0.00558	$686 \times 10^{-6}$
0.0625	0.00279	$365 \times 10^{-6}$
0.0313	0.00139	$194 \times 10^{-6}$
0.0156	0.00070	$100 \times 10^{-6}$
0.0078	0.00035	$52 \times 10^{-6}$

Applying equation<sup>1</sup> (1) to the above cited results and enumerating the constants  $\frac{1.037 \times 10^{-2}}{\rho(u+v)}$  and  $\frac{1.075 \times 10^{-4}}{K\rho(u+v)^2}$  from all of the experimental data by the method of least squares we obtain, for salmin sulphate:

$$m = 9.09 x + 6408 x^2 \dots \dots \dots (2)$$

where  $m$  is the equivalent concentration of combined acid in the solution and  $x$  is its conductivity.

For salmin chloride we obtain:

$$m = 6.92 x + 1781 x^2 \dots \dots \dots (3)$$

Applying, instead of equation (1), the equation:

$$m = \frac{1.037 \times 10^{-2}}{\rho(u+v)} x + \frac{1.115 \times 10^{-6}}{K\rho(u+v)^3} x^3 \dots \dots \dots (4)$$

which is the corresponding form of the dilution law for an electrolyte which dissociates into *three* ions,<sup>2</sup> we obtain, for salmin sulphate:

$$m = 10.58 x + 6.02 \times 10^6 x^3 \dots \dots \dots (5)$$

and for salmin chloride:

$$m = 7.28 x + 1.82 \times 10^6 x^3 \dots \dots \dots (6)$$

In the following tables the experimental values of  $m$  and those computed from the observed conductivities with the aid of the above equations are compared:

<sup>1</sup> Cf. Introduction.

<sup>2</sup> T. Brailsford Robertson: "Die physikalische Chemie der Proteine," Dresden, 1912, p. 216.

TABLE III—SALMIN SULPHATE

Equivalents of H <sub>2</sub> SO <sub>4</sub> per litre of solution			Degree of dissociation of the salmin sulphate	
Experimental	Calc. from Equation 2	Calc. from Equation 5	Calc. from Eqn. 2 Percent	Calc. from Eqn. 5 Percent
0.01053	0.01057	0.01065	65	76
0.00842	0.00834	0.00824	69	80
0.00526	0.00527	0.00518	76	89
0.00263	0.00267	0.00274	85	100
0.00132	0.00137	0.00146	94	100
0.00066	0.00071	0.00079	100	100
0.00033	0.00035	0.00040	100	100
	$\Sigma\Delta = + 0.00003$	$\Sigma\Delta = + 0.00031$		

TABLE IV—SALMIN CHLORIDE

Equivalents of HCl per litre of solution			Degree of dissociation of the salmin chloride	
Experimental	Calc. from Equation 3	Calc. from Equation 6	Calc. from Eqn. 3 Percent	Calc. from Eqn. 6 Percent
0.00558	0.00559	0.00558	85	89
0.00279	0.00276	0.00275	92	97
0.00139	0.00141	0.00143	95	99
0.00070	0.00071	0.00073	97	100
0.00035	0.00036	0.00038	100	100
	$\Sigma\Delta = + 0.00002$	$\Sigma\Delta = + 0.00006$		

The degrees of dissociation which are enumerated in these tables are computed from the ratios of  $\frac{1.037 \times 10^{-2}}{\rho(u+v)} x$  to the calculated values of  $m$ .

The agreement between the experimental values of  $m$  and those calculated from equations 2 and 3 (dilution-law for a binary electrolyte) is highly satisfactory. The agreement

between the experimental values of  $m$  and those calculated from equations 5 and 6 (dilution-law for a tertiary electrolyte) is not so good. It would appear probable, therefore, that the sulphate and chloride of salmin yield 2 ions each (or a multiple of 2) on dissociation, and not 3 or a multiple of 3. The evidence afforded by conductivity determinations is, however, not sufficient, taken by itself, to enable us to determine the number of ions yielded by a molecule of an electrolyte;<sup>1</sup> for this additional data, which may be derived from cryoscopic measurements, are requisite.

#### (d) The Cryoscopic Determinations

One-half percent or more concentrated solutions of salmin sulphate, on being cooled to the neighborhood of  $0^{\circ}\text{C}$ , become diphasic, the salmin sulphate separating out in the form of an oil; consequently solutions of salmin sulphate cannot be employed for the purpose of cryoscopic measurements.

A  $\frac{1}{2}$  percent solution of salmin chloride was investigated cryoscopically. Three successive determinations yielded the result:  $\Delta = 0.04^{\circ} \pm 0.003$  corresponding to a molecular + ionic concentration of  $M/46$ .

The equivalent-concentration of  $\text{HCl}$  neutralized by salmin in a  $\frac{1}{2}$  percent solution of salmin chloride is  $M/45$ . Each molecule of neutralized hydrochloric acid yields therefore one molecule or one ion of salmin chloride.

The equivalent conductivity of a solution of salmin chloride (or sulphate) does not increase more than 15 percent on dilution from  $\frac{1}{8}$ - $\frac{1}{128}$  percent and at a dilution in the neighborhood of  $\frac{1}{64}$  percent approximates to constancy. Consequently, these salts are highly ionized in solution and we may conclude, from the above-cited result, *that two molecules of hydrochloric acid, in uniting with salmin, yield two ions of salmin chloride.*

One molecule of salmin chloride contains at least four

<sup>1</sup> cf. T. Brailsford Robertson: "Die physikalische Chemie der Proctine," Dresden, 1912, p. 202.

molecules of combined hydrochloric acid.<sup>1</sup> Hence one molecule of salmin chloride must yield four ions or a multiple thereof. On the assumption, which is borne out by the behavior of other protein salts,<sup>2</sup> that each pair of these ions is capable of combining the true relationship between the conductivity and the dilution of a solution of protamin chloride is that expressed by equations 1 or 3, namely that which is characteristic of a binary electrolyte.

### 3. THEORETICAL

The protein salts of inorganic acids and bases which have hitherto been investigated do not dissociate the inorganic radicle as such but bound up in a complex protein ion.<sup>3</sup> That this is also the case with salmin chloride may easily be inferred from the above-cited data. If each hydrochloric acid molecule bound up in a molecule of salmin chloride were to yield a chlorine ion to the solution then each molecule of hydrochloric acid would lead to the appearance of two, or at any rate, more than one ion in the solution.

From the value of the constant  $\frac{1.037 \times 10^{-2}}{\rho(u+v)}$  in equation 1 as yielded by equation 3, we can estimate the value of the constant for salmin chloride. We thus find it to be:  $150 \times 10^{-5}$ .

The sum of the migration-velocities of two protein ions under unit potential-gradient at 30° C is from  $30 \times 10^{-5}$  cm per second to  $40 \times 10^{-5}$  cm per second. Dividing the above value of  $\rho(u+v)$  by  $40 \times 10^{-5}$  we obtain, in round numbers,  $\rho = 4$ .

Hence, if salmin chloride dissociates into two or a multiple of two *protein* ions, their valency must be 4.

Summing up the inferences which we have drawn from the above data, therefore, we may conclude that *each molecule*

<sup>1</sup> Cf. Introduction.

<sup>2</sup> Cf. T. Brailsford Robertson: "Die physikalische Chemie der Proteine," Dresden, 1912.

<sup>3</sup> Cf. previous articles of this series. Also "Die physikalische Chemie der Proteine," loc. cit.

of salmin chloride yields four 4-valent protein ions. Since salmin sulphate would also appear to obey the dilution law for a binary electrolyte rather than that for a tertiary electrolyte, we may assume with plausibility that salmin sulphate dissociates in an analogous manner

These phenomena are obviously analogous to those displayed by the caseinates of the alkalies<sup>1</sup> and correspond with those which would be exhibited by a salt which forms and dissociates in accordance with equations of the type:

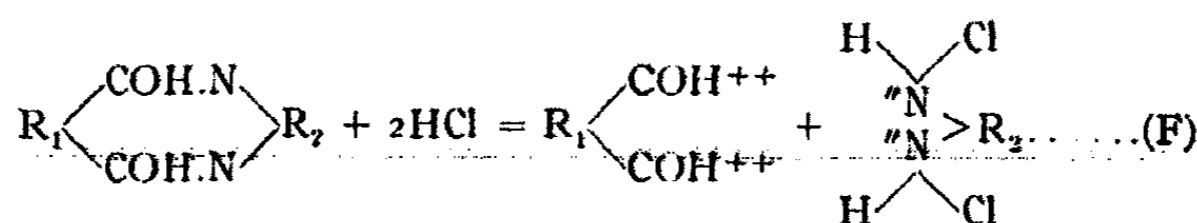

and

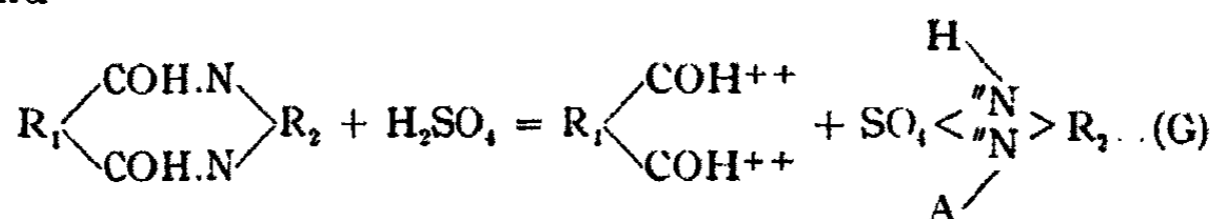

this process of combination and dissociation being repeated twice, *i. e.*, at four COH.N linkages in each molecule of salmin. It will be obvious that the properties of a salt formed according to these equations would in every way correspond with those of salmin chloride and sulphate, respectively, in so far as they have been observed. Every two molecules of neutralized acid would yield two 4-valent ions. None of the reactions illustrated by equations B, C, or D in the introduction would yield a salt exhibiting these properties, nor would any process of combination involving monoamino radicles, so far as we know at present, yield one quadrivalent ion for each molecule of neutralized acid.

We may therefore conclude that the behavior of salmin chloride or sulphate in solution is such as to indicate that *diamino-radicles are responsible for the neutralization of acids by salmin* and not only that the anions of these salts are formed from diamino radicles, but that the cations, also, are either

<sup>1</sup> Cf. Equation A in the introduction.

formed from diamino radicles or from monoamino radicles which remain linked in pairs.

These inferences are in remarkable harmony with our knowledge of the structure of the salmin molecule. As is well known from the work of Kossel, the protamins as a group are characterized by their high diamino-acid content, salmin containing 87.4 percent of arginin.<sup>1</sup> According to Kossel and Dakin the proportion of diamino to monoamino radicles in salmin is 2 : 1 and, according to the same authors, salmin may be constructed from the union of 10 mol. arginin + 2 mol. serin + 1 mol. aminovalerianic acid + 2 mol. prolin or else from the union of 12 mol. arginin + 2 mol. serin + 1 mol. aminovalerianic acid + 3 mol. prolin. If we were to accept the latter formula, that of salmin chloride would be: 12 mol. arginin + 2 mol. serin + 1 mol. aminovalerianic acid + 3 mol. prolin + 12 mol. HCl. Recalling the fact that each diamino-radicle can neutralize two molecules of hydrochloric acid, it will be evident that in neutralizing twelve molecules of hydrochloric acid only half the arginin radicles would be used up. It is inviting to suppose that the remainder form the corresponding cations.

Assuming the valencies of the ions produced by salmin sulphate and chloride to be 4, we can compute, from the values of the constants in equations 2 and 3, the values of  $u + v$  and of  $K$  (the sum of the specific ionic migration velocities and the dissociation-constant, respectively) for these two salts. The results are enumerated in the accompanying table:

TABLE V

Salt	$(u + v)$ in cm per sec. per unit potential gradient	$K =$ dissociation constant
Salmin sulphate	$28.5 \times 10^{-5}$	0.0516
Salmin chloride	$37.5 \times 10^{-5}$	0.1076

<sup>1</sup> A. Kossel and H. D. Dakin: *Zeit. physiol. Chem.*, 41, 412 (1904).

## 4. CONCLUSIONS

(1) Solutions of the chloride and sulphate of salmin obey the Ostwald dilution law for a binary electrolyte.

(2) The depression of the freezing point of water which is brought about by the presence of dissolved salmin chloride is equal (in 1/2 percent solution) to the depression which would be produced by a dissolved substance of the same molecular (or molecular + ionic) concentration as that of the combined acid. Each molecule of combined acid, therefore, produces one ion (or molecule) in the solution of salmin chloride.

(3) It is probable that each multiple of  $C_{30}H_{57}N_{17}O_6 \cdot 4HCl$  in the molecule of salmin chloride dissociates yielding four quadri-valent ions.

(4) It is suggested that the formation and dissociation of salmin chloride takes place in accordance with equations of the type:

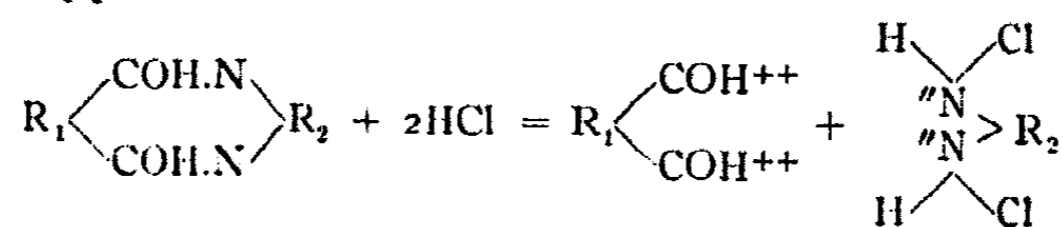

while the formation and dissociation of salmin sulphate takes place in accordance with equations of the type:

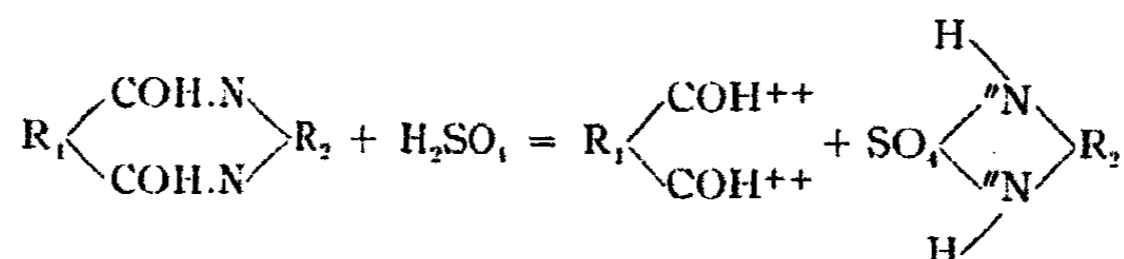

(5) The experimental data enumerated in this article are in harmony with the view that half of the arginin radicles in the salmin molecule unite with acid to form the anions of the salt, while the remainder of the arginin radicles form the corresponding cations.

## THE ACTION OF WATER VAPOR ON GELATINE

BY WILDER D. BANCROFT

It was found by von Schroeder,<sup>1</sup> in Ostwald's laboratory, that a piece of gelatine apparently did not reach the same equilibrium point in presence of saturated water vapor that it did when immersed in liquid water. Some gelatine was liquefied and then allowed to solidify in the form of a plate. The solidified mass consisted of 0.679 gram gelatine and 0.122 gram water. This plate was immersed in water with the result shown in Table I.

TABLE I  
Weight of dry gelatine, 0.679 gram

Time of immersion	Water content of gelatine plate	
	Grams	Percent adsorbed
0 min.	0.122	17.0
5 min.	2.282	336.1
10 min.	2.934	432.1
20 min.	3.669	540.3
30 min.	4.072	599.7
40 min.	4.300	633.3
50 min.	4.415	650.2
60 min.	4.506	663.6
2 hours	4.941	727.7
24 hours	6.911	1018.0
48 hours	7.734	1139.0

The experiment was stopped after forty-eight hours and another gelatine plate containing a large amount of water was placed in a space saturated with water vapor, the temperature being the same as in the preceding experiment. It was supposed that the gelatine would not lose water under these circumstances; but this proved not to be the case. The data are given in Table II.

<sup>1</sup> Zeit. phys. Chem., 45, 109 (1903).



TABLE II  
Weight of dry gelatine, 0.433 gram

Time in vapor phase	Water content of gelatine plate	
	Grams	Percent adsorbed
0 day	—	—
1 day	4.659	1076
2 days	4.400	1016
3 days	4.322	998
4 days	4.276	988
5 days	4.241	979
7 days	3.730	861
9 days	3.346	759
11 days	2.687	621
14 days	2.088	482
	1.484	343

By standing for fourteen days in saturated water vapor, the gelatine went down to about the water concentration which fairly dry gelatine would have had after standing five minutes in liquid water at the same temperature.

Other experiments were made with gelatine plates which had only been allowed to stand a relatively short time in water and which, therefore, had not taken up anything like the maximum amount of water. These also lost water when placed in the vapor phase. A similar result was obtained with an Agar-agar plate which had been allowed to swell in water. On the other hand, a piece of filter paper which had been left for an unspecified time in water gained a little in weight when placed in the vapor phase.

Von Schroeder then tried placing a dry gelatine plate in presence of saturated water vapor. The results are given in Table III.

This plate had apparently reached equilibrium in presence of saturated water vapor; but it increased rapidly in weight when immersed in water at the same temperature, as can be seen from the data in Table IV.

TABLE III  
Weight of dry gelatine, 0.904 gram

Time in water phase	Water content of gelatine plate	
	Grams	Percent adsorbed
0 day	0.0 ?	0.0?
1 day	0.154	17.1
2 days	0.218	24.1
3 days	0.277	30.7
4 days	0.294	32.6
5 days	0.347	36.2
7 days	0.357	39.5
8 days	0.366	40.5
15 days	0.372	41.2
17 days	0.368	40.7
18 days	0.369	40.8
20 days	0.374	41.4

TABLE IV  
Weight of dry gelatine, 0.904 gram

Time of immersion	Water content of gelatine plate	
	Grams	Percent adsorbed
0 min.	0.374	41.4
15 min.	3.283	363
30 min.	4.739	524
45 min.	5.397	597
60 min.	6.002	664

If a gelatine plate is placed vertically with the lower part in the water and the upper part in the vapor, the lower part will swell much more than the upper part; and the dividing line will be quite sharp. Von Schroeder points out that these experiments show that the vapor pressure of water in gelatine must be higher than the vapor pressure of pure water because water distills from the gelatine to the vapor phase. He also points out that the vapor pressure of the water in the gelatine can be lowered by allowing the gelatine to swell in a salt solution instead of in pure water. By making

the salt solution concentrated enough, the gelatine should then take up more water when placed in a vapor phase saturated with respect to pure water. This proved to be the case. If the gelatine plate was allowed to swell in a N/100,000 sulphate solution, it increased further in weight when placed over pure water. If allowed to swell in a N/1,000,000 sulphate solution, the gelatine lost water when placed over pure water. Von Schroeder gives some data for the two cases; but they are rather unintelligible. He says that the gelatine, which had swelled in the N/100,000 sulphate solution, showed the following increases in weight when placed in the vapor phase:

After 24 hours	1.318 grams
After 48 hours	1.341 grams
After 72 hours	1.351 grams

There is nothing to show to what weight of dry gelatine this refers or how much water the gelatine took up while in the sulphate solution. It seems probable that the unknown amount of gelatine, containing the unknown amount of water, took up 1.318 grams water in the first twenty-four hours and 0.0033 gram in the next forty-eight hours; but it may be that the gelatine plate took up 4.010 grams (1.318 + 1.341 + 1.351) in seventy-two hours. This last guess is perhaps the more probable in view of the fact that von Schroeder says that "with a N/1,000,000 sulphate solution there was a distinct loss of water:

After 24 hours	1.210 grams
After 48 hours	1.107 grams
After 72 hours	0.814 gram

This ought to mean that the gelatine lost 3.131 grams (1.210 + 1.107 + 0.814) in seventy-two hours unless von Schroeder by mistake has given the actual weight of the gelatine plate; but in that case he ought to have given the initial weight. Fortunately, it is quite immaterial what his real data were. The essential thing is that the difference between the vapor pressure of pure water and of N/100,000 sulphate solution is apparently sufficient to keep a mass of

0.433 gram dry gelatine + 4.659 grams water from losing over three grams of water (cf. Table II) when placed in saturated water vapor. As von Schroeder justly remarks: "These experiments show that very considerable changes in the degree of swelling of a gelatine plate are caused by very slight changes in the vapor pressure of the swollen gelatine."

It seemed possible that these extraordinary results might be due to the action of gravity causing the liquid water to sink down in the meshes of the gelatine when this latter was placed in the vapor phase. I quote von Schroeder's<sup>1</sup> experiments in regard to this and also his tentative solution of the problem.

"A gelatine cylinder, which had swelled in water, was placed as a plug in an inverted flask having no bottom. The flask was supported on a tripod so that the neck dipped into a crystallizing dish filled with water. The flask was filled with water and, in order to keep a vapor phase saturated with respect to water, a large beaker lined with moist filter paper was inverted over the flask, the rim of the beaker resting on the bottom of the crystallizing dish. A trace of mercuric iodide kept the gelatine from spoiling. No formation of drops at the lower end of the gelatine plug could be detected though the experiment ran for over four months.

"Equally unsuccessful was another experiment along similar lines. A swollen gelatine cylinder was suspended in a vapor phase saturated with respect to water and was watched to determine whether the lower end of the cylinder formed drops or swelled more, and whether the upper end shriveled.

"I then had made a tubular vessel with a small side-vessel blown on. The gelatine plate was fastened on a glass frame and placed in the main vessel while the side-vessel was filled with water. The air was pumped out of the apparatus which was then sealed. When the water was in the side-vessel it was above the gelatine. By tipping the apparatus, water could be brought into the main vessel under the gelatine. By tipping the apparatus more, the gelatine could

<sup>1</sup> *Zeit. phys. Chem.*, 45, 114 (1903).

be flooded. If desired the water could all be poured back into the side-vessel. It was thus possible to let the gelatine swell while entirely in the water vapor, then to let the gelatine swell while half in the water, and finally to observe the swelling when the gelatine was completely immersed. When the water was poured back into the side-vessel, it was possible to note the shrinking of the gelatine even when the level of the water was higher than the gelatine. Even this experiment was not decisive.

"By determining qualitatively the rise in capillary tubes according to the method of Röntgen and Schneider,<sup>1</sup> it was found that the surface tension of a dilute gelatine solution against air is less than the surface tension of water against air. Quantitative measurements of the same sort have been made by Quincke.<sup>2</sup>

	Sp. g.	Surface tension against	
		air	water
Water	1.000	8.253	0
Gelatine (very dilute)	1.000	7.277	0
Agar-agar (very dilute)	1.000	7.842	0
Fish glue (very dilute)	1.000	6.790	0

"I have only found one reference in the literature to any difference in the degree of swelling in water and in water vapor. Volbehr<sup>3</sup> writes that it is not necessary that all the water, taken up by a substance when swelling, should be adsorbed by the frame work. There may also be interstices filled with water which ought not to be counted when considering the affinity between water and substance. Of course this water is much less in amount than the total which a swelling substance can take up. By this way of wording, Volbehr does not eliminate the apparent contradiction between the admitted facts and the second law of thermodynamics.

<sup>1</sup> Ostwald-Luther: Hand- und Hilfsbuch, 263.

<sup>2</sup> Wied. Ann., 35, 580 (1888).

<sup>3</sup> Untersuchungen über die Quellung der Holzfaser: Kiel, 1896.

"It is undoubtedly safe to say that the second law holds in this case and that is why I speak of an apparent contradiction. There may have been some experimental error, such as that the vapor phase was not saturated or that the temperature was not constant, in spite of the fact that I was particularly careful in regard to both of these points. If not, then there could not have been equilibrium between the swelling substance and either the water or the water vapor.

"The fact that the phenomena could be repeated as often as desired is an argument against the assumption that the error is due to any irreversible process. We must seek an explanation of the apparent anomaly in the fact that the rate with which a reversible process takes place plays an important part in the calculation of the work-equivalent of that reversible process. If we keep in mind the principle put forward by Maxwell, Gibbs, Le Chatelier, and van't Hoff, in regard to the resistance of a system to a compulsory change [theorem of Le Chatelier] and if we keep especially in mind the theorem of Gibbs that a suddenly decreased surface has temporarily a smaller surface tension than the equilibrium one, we can at any rate give a qualitative explanation of this apparently puzzling phenomenon.

"To illustrate this, I will cite a concrete case in which one passes from the same original state to what appears to be the same final state isothermally and reversibly with two different expenditures of work, in apparent defiance of the second law of thermodynamics. We start with a cylinder in which there is a movable piston so that we can change the volume and pressure relations of the water vapor in the cylinder at will. The cylinder is connected by a capillary, having an infinitely small cross-section, to a water reservoir which is filled with water up to the capillary. The whole apparatus is supposed to be in a thermostat so that all changes take place isothermally. Let the water vapor have the volume  $v_1$  and then raise the piston by the volume  $v$ , the piston being raised infinitely slowly. In this case the work done by the

machine is  $p v$  where  $p$  is the pressure of the saturated vapor. If, however, the piston rises only so slowly that temperature and pressure are always at equilibrium values but fast enough so that there is not time for a perceptible amount of water to evaporate from the reservoir into the cylinder through the capillary, the work done during the same expansion  $v$  will be  $v_1 p \log \frac{v_1 + v}{v_1}$  and it will be done practically reversibly.

Although the system is now externally in the same state (the piston is exactly in the same position), the system is, nevertheless, not in definite equilibrium and the two amounts of work are different.

"In our particular case this would mean that the gelatine with its extremely high viscosity is readily susceptible to hysteresis effects with reference to surface tension. The rapid expansion of the swelling gelatine when in the water would correspond to the rapid movement of the piston, and would involve more work than was necessary for the slow swelling of the gelatine in the vapor phase which corresponds to the slow movement of the piston. This difference in the work-equivalents would then be the cause of the gelatine losing water when placed in the vapor phase."

It is doubtful whether this alleged explanation has ever satisfied anybody. Freundlich<sup>1</sup> gives a different one.

"The different behavior of an elastic gel towards liquid water and towards saturated water vapor is not easily accounted for. In the vapor phase water will unquestionably be adsorbed by the wetted walls of the gel as shown in the diagram.<sup>2</sup> In accordance with what we have said about cotton and in accordance with the steep pitch of the curve it is probably very difficult to reach a definite equilibrium because the adsorbed water gradually dissolves in the walls of the gel, reacts with them, etc. In liquid water these changes take place very much more rapidly: the water dissolves in the walls of the gel (and the gel dissolves to some extent

<sup>1</sup> Kapillarchemie, 496 (1909).

<sup>2</sup> Freundlich: Kapillarchemie, 179 (1909).

in the water), the walls change their volume, new surfaces are formed, etc. Swelling takes place and reaches a not very definitely marked limit when the elastic contracting forces of the gel just balance those forces which tend to increase the volume. It is also to be noticed that the gel, which has swollen to the maximum amount, is under water and that the outer, limiting parts of the gel are under the influence of the attracting forces of the adjoining, surrounding portions of the water and that they are therefore just as much under a uniform pressure as a particle of liquid in the midst of the liquid.

~~"This state of things changes when the swollen gel is brought into the saturated vapor phase. It is no longer surrounded by liquid in mass and the pull due to that drops out. Therefore, the elastic walls of the gel press on the water inside the gel. Since these walls are presumably more permeable to water vapor than to liquid water, the vapor pressure of the water in the cavities of the gel is increased and consequently we have evaporation and a shrinking of the gel. From this it follows that it is not a matter of indifference whether the swollen gel is removed slowly or rapidly from the liquid. If it is removed infinitely slowly, the part projecting into the vapor phase must shrink. That portion of the water which is held weakly, will not be carried along. The surface tension between the walls of the water or the air is changed and, therefore, the work-equivalent is different. There is no violation of the second law of thermodynamics, though there seems to be when we say that a system which is in equilibrium with liquid water is not in equilibrium with saturated water vapor. The rapid transfer<sup>1</sup> of the gel from the liquid phase to the vapor phase is not a reversible process."~~

Although this explanation is based on Schroeder's, it is an improvement on it. Even in this form it is neither very clear nor very convincing. The whole matter seems to me quite simple if one takes into account the structure

<sup>1</sup> Von Schroeder: *Zeit. phys. Chem.*, 45, 117 (1903).



of the gel. We are dealing with a cellular structure. If we place a dry paper bag in a space saturated with water vapor, the paper will adsorb a certain amount of water; but there will be no tendency for the water to condense inside the bag and to fill it with liquid water. If we put this same bag into liquid water, the paper will take up water as before; but water will also pass into the bag and fill it because then the surface between liquid and paper will be a minimum with reference to the mass of liquid inside the bag, the surface of contact remaining constant while the mass of water inside the bag increases. If we lift the bag into the vapor phase, and if the bag is so constructed that the actual dripping is negligible, the water will distill from the curved surface in the bag to the plane surface in the containing vessel. The smaller the bag is, the greater will be the curvature of the water within and consequently the higher the vapor pressure. With the microscopic spaces in solidified gelatine, the vapor pressure of the drops of water will be enough higher than that of water in mass to counterbalance the differences of level in von Schroeder's experiments. Since we know that a N/100,000 sulphate solution cuts down the vapor pressure of the drops to below that of water in mass, it would be a simple matter for anybody mathematically inclined to calculate what the vapor pressure of the drops is when they consist of pure water and from that what their dimensions are. Since filter paper and water do not form a gel, the abnormal phenomena were not obtained by von Schroeder in this case.

An objection to my explanation is that a paper bag full of water does bulge at the lower end and that von Schroeder looked for this effect and could not find it. The reason that he did not find it is because his methods of measurement were not sensitive enough. In the case of gelatine we have the equivalent of myriads of small paper bags. Each one undoubtedly bulges at the lower end when the gelatine is placed in the vapor phase. Since it is very difficult to make out the cellular structure even under the microscope, it is quite clear that one could not hope to detect a bulging at the

lower end by examining a strip of gelatine with the naked eye. In von Schroeder's experiments the lower ends, that he was looking for, extended practically to the top. His gelatine was all lower ends—and upper ends.

Another good point about the explanation I have offered is that it accounts for the relatively large amounts of water which are taken up by the gelatine when it swells under water. The amount of water which a paper bag will hold is out of all proportion to the amount of water which can be adsorbed by the paper itself. While some gelatine will dissolve or disintegrate in the water, we may neglect this and other disturbing factors for the present. As a first approximation it is probably safe to say that the water taken up from the vapor phase goes into the cell walls. The bulk of the excess taken up when the gel swells under water goes into the cavities. Assuming the facts to be as stated in Tables I-IV, water to the extent of about forty percent of the dry weight of the gelatine was taken up by the cell walls while water to the extent of at least eleven hundred percent of the dry weight of the gelatine was inside the cells. If we take an alumina jelly<sup>1</sup> with 1/600 of alumina by weight, only a negligible proportion of the water is in the cell walls. We cannot realize this experimentally as yet by letting alumina swell because we do not get sufficiently elastic cell walls in the case of precipitated alumina; but this dilute alumina jelly corresponds theoretically to the swollen gelatine.

The general results of this paper are:

1. The behavior of swollen gelatine in liquid water and in saturated water vapor is a necessary consequence of the cellular structure of the gelatine jelly, and does not involve any assumption of irreversible changes.

2. The microscopic globules of water in the gelatine cells have a higher vapor pressure, owing to their curvature, than water in mass. The swollen gelatine, therefore, loses water in contact with saturated water vapor.

3. When gelatine swells in a N/100,000 sulphate solution,

<sup>1</sup> Crum: Jour. Chem. Soc., 6, 216 (1854).

the globules have a lower vapor pressure than that of water in mass. When gelatine swells in a N/1,000,000 sulphate solution, the globules have a higher vapor pressure than that of water in mass.

4. From the data in regard to solutions, it would be possible to make a first approximation as to the size of the water globules in a gelatine jelly.

5. As a first approximation we may consider that the equilibrium in contact with saturated vapor gives us the liquid in the cell walls. The excess amount taken up when the gel is immersed in the liquid represents, as a first approximation, the liquid inside the cells.

6. An alumina jelly is equivalent theoretically to a swollen alumina though it has never been prepared in that way.

7. All conclusions in regard to partial pressures of gels are subject to modification in so far as the colloidal substance forms a true solution under the conditions of the experiment.

8. Moistened filter paper is not a gel and therefore does not show von Schroeder's phenomenon.

*Cornell University*

## THE DECOMPOSITION OF BROMOFORM

BY GEORGE J. SARGENT

E. D. Campbell<sup>1</sup> made some bars of annealed crucible steel, containing 1.29 percent carbon, anode in a 4 percent hydrochloric acid solution. A weak current was passed through the solution. After fifteen or sixteen hours the bars were removed, the adhering residue brushed off, and then placed in a fresh solution and the process repeated. The residues were collected and washed by decantation. Only the heavier particles were allowed to settle.

The result was a heavy, bright, steel-gray powder which appeared, under the microscope, as thin plates or scales. Its carbon and its iron content agreed quite well with the formula  $\text{Fe}_3\text{C}$ . By alternately moistening and then drying in an air bath at a temperature of about  $70^\circ\text{C}$  for six weeks, it was slowly but completely oxidized to  $\text{Fe}_2\text{O}_3$ . The carbide was practically completely soluble in moderately concentrated hydrochloric acid, with the evolution of hydrogen and hydrocarbon of the paraffin and olefine series. Campbell found that the paraffin hydrocarbons consisted almost entirely of ethane, and the olefine hydrocarbons principally of ethylene and butylene with some dibutylene.

To quote Campbell: "As early as 1864, Hahn,<sup>2</sup> and, again in 1877, Cloez<sup>3</sup> showed, by dissolving cast irons in dilute hydrochloric or sulphuric acid, that a portion of the carbon passed off with the hydrogen as ethylene,  $\text{C}_2\text{H}_4$ , propylene,  $\text{C}_3\text{H}_6$ , butylene,  $\text{C}_4\text{H}_8$ , and dibutylene,  $\text{C}_8\text{H}_{16}$ . This they showed by passing the gas through bromine and purifying and fractionally distilling the dibrom derivatives thus obtained.

"At the time of Hahn's and Cloez's work no definite

<sup>1</sup> Jour. Am. Chem. Soc., 18, 836 (1896).

<sup>2</sup> Liebig's Ann., 129, 57 (1864).

<sup>3</sup> Comptes rendus, 85, 1003 (1877).

carbide of iron had been isolated, and no possible explanation offered for presence of the gaseous products of solution of a mixture of hydrogen, olefins and paraffins. We would recall two well-known facts before offering a possible explanation for the composition of the gas evolved in dissolving iron containing carbon. The first of these is the tendency of the olefine with the general formula  $C_nH_{2n}$ , to combine with nascent hydrogen to form the corresponding paraffins,  $C_nH_{2n+2}$ , and also the tendency of some of the higher olefines, especially butylene,  $C_4H_8$ , and those of a higher molecular weight to form condensation products.

"It would seem not unreasonable to assume that iron is capable of forming a series of what we might properly term ferro-carbons analogous to the olefine series of hydrocarbons; that this series has the general formula  $C_nFe_{3n}$ , in which the group  $-Fe-Fe-Fe-$  replaces  $H_2$  in the olefine series,  $C_nH_{2n}$ ; that, when these ferro-carbons are acted upon by an acid, such as hydrochloric or sulphuric acid, the first reaction is the substitution of two hydrogen atoms for the two iron atoms, thus producing the analogous olefine,  $C_nH_{2n}$ , free hydrogen being liberated between the iron atoms. Thus, the primary products of solution of these ferro-carbons would be olefines,  $C_nH_{2n}$ , and hydrogen, but, owing to the tendency of the olefines to combine with nascent hydrogen, the secondary reaction producing a greater or less proportion of paraffins would take place.

"That this is probably the case is rendered the more probable from the fact that the proportion of paraffins to olefines varies somewhat with varying conditions of solution. The first reaction in the case of the simplest of these ferro-carbons,  $C_2Fe_6$ , when dissolved in hydrochloric acid, is as follows:



Or the reaction may be represented graphically as follows:

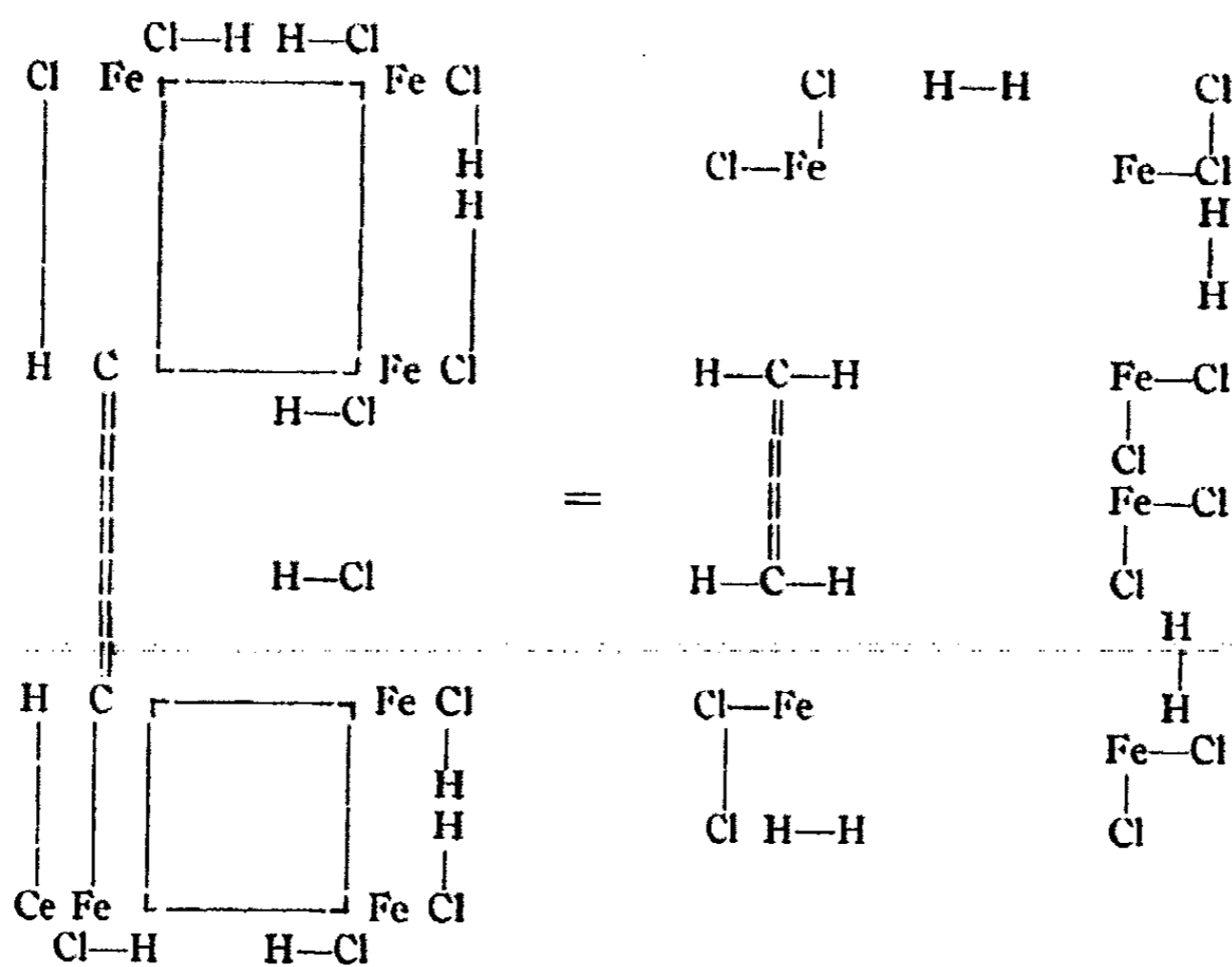

"The secondary reaction between hydrogen and the olefines would be one of direct addition to form the homologous paraffins."

Campbell's assumed structure of the hypothetical series of ferro-carbons has the defect, that while the first member of the series  $\text{C}_2\text{Fe}_6$ ,  $\text{Fe—Fe—C=C—Fe—Fe}$  on treatment with acids

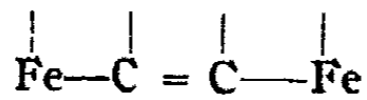

would give  $\text{H}_2\text{C} = \text{CH}_2$ , the second member of the series  $\text{C}_3\text{Fe}_9$ ,

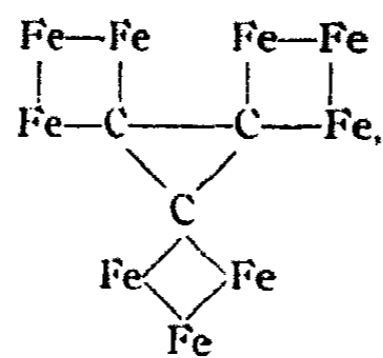

would give

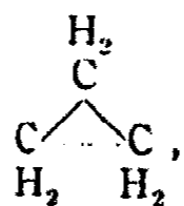

THE DECOMPOSITION OF BROMOFORM. BY J. W. BOYD AND J. W. BOYD, JR.

trimethylene, not propylene. The third member of the series,  $C_4Fe_{12}$ , would give

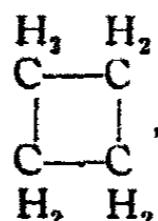

tetramethylene, not butylene.

The work of Gladstone and Tribe<sup>1</sup> on the decomposition of chloroform, bromoform, and iodoform by the zinc-copper couple seemed at least to suggest a simpler explanation for the composition of the gas evolved when iron containing carbon is dissolved in acids.

Gladstone and Tribe used a zinc-copper couple prepared by treating some well-crumpled zinc foil with a dilute copper sulphate solution, whereby the zinc becomes coated with a deposit of copper. The couple was then washed and dried. It was found to have no appreciable action on chloroform either alone or in the presence of ether.

Gladstone and Tribe used a solution of 5 cc (7.5 grams) of chloroform dissolved in 20 cc of absolute alcohol. The action of the couple on this solution began at a temperature of about 50° C. The reaction was represented by the equations

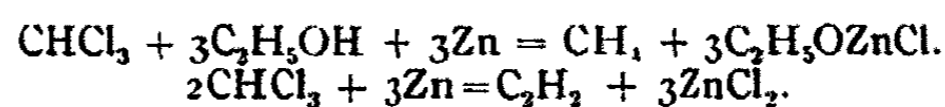

The reactions ran nearly to completion. A yield of 1.7 percent acetylene meant that 1.7 percent of the total chloroform in the solution was decomposed to form acetylene.

A moist couple acted on chloroform at ordinary temperatures according to the equation

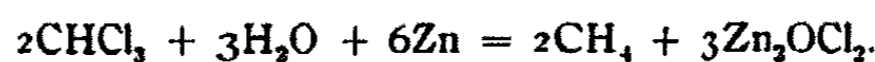

The action of the couple on a bromoform solution consisting of 2.5 cc (7 grams) bromoform in 20 cc of absolute alcohol was very rapid at room temperatures. A yield of 19 percent acetylene was obtained. The reaction ran nearly

<sup>1</sup> Jour. Chem. Soc., 28, 508 (1875).

to completion as shown by the amount of zinc and bromine in solution, yet the amount of  $C_2H_2$  and  $CH_4$  obtained accounted for only slightly over one-half of the bromoform. When zinc foil was substituted for the couple, the action at  $50^\circ C$  was slight, but fairly rapid at  $60^\circ C$ . The yield of acetylene was greatly decreased being only 1.73 percent, also there was little loss of any of the CH of the bromoform. At ordinary temperatures the action of the moist couple on bromoform was very slow, methane being evolved; at  $60^\circ C$  a little acetylene was found mixed with the methane.

The action of the couple on an alcoholic solution of iodoform was extremely slow at ordinary temperatures, probably due to the slight solubility of the iodoform. In one experiment 8.45 grams of iodoform and 10 cc of absolute alcohol were added to the couple and the whole heated to  $40^\circ C$ . A yield of 27.4 percent of acetylene was obtained. There was a very considerable loss of the CH of the iodoform. When zinc foil was substituted for the couple, a yield of only 15 percent of acetylene was obtained. The loss of CH was far less than with the couple. Gladstone and Tribe thought that the loss of CH might be due to the formation of benzene, but tests gave only negative results. It was then thought that copper acetylide might have been formed on the surface of the copper in the couple. Accordingly the couple at the end of the reaction was washed with alcohol, then with water, dried and burned with copper oxide. An amount of carbon dioxide closely corresponding to the loss of CH was obtained. Thinking that a greater yield of acetylene would be obtained by substituting platinum for the copper of the couple, since acetylene was not known to combine with platinum, a zinc-platinum couple was used. The action of this couple on an alcoholic solution of iodoform was more energetic than that of the zinc-copper couple. The yield of acetylene was about the same as that obtained when the zinc-copper couple was used. The loss of CH was also very nearly the same.

The following research was undertaken to determine whether the yield of acetylene could be appreciably varied



by varying the concentration of the reacting solution. Bromoform was selected in preference to chloroform owing to the greater yield of acetylene, and in preference to iodoform owing to the limited solubility of the latter in alcohol. Since difficulty was experienced in the preparation of the zinc-copper couple by the method of Gladstone and Tribe, the method proposed by Lachman<sup>1</sup> was used, with a slight modification. A mixture of 12 parts of cupric oxide and 88 parts of zinc dust was heated in a combustion tube to dull redness for twenty minutes, with a stream of dry hydrogen passing through. In order to obtain as uniform a couple as possible, a considerable amount of the couple was prepared and mixed by shaking as uniformly as possible. It was noticed in some preliminary experiments, that the couple after some time appeared less active. This was believed to be due to a slow oxidation of the zinc by the oxygen of the air. To prevent this as far as possible the couple was kept in a flask in an atmosphere of hydrogen. In all the experiments the same amount of the couple was used, namely, 15 grams. It is recognized, however, that the use of the same amount of couple in each experiment does not ensure that the same extent of surface of the sample is in contact with the bromoform solution.

The decomposition of the bromoform was carried on in a flask with a capacity of about 60 cc fitted with a three-holed rubber stopper. Through one hole was introduced a thermometer, through another the tip of a burette, and through the third hole a capillary tube which connected the flask with a gas storage pipette. Owing to the solubility of acetylene in water or even in a salt solution, the gases were collected over mercury.

As it was usually necessary to heat the bromoform solution, especially the more dilute ones, in order to start the reaction and often necessary to cool them after the reaction had started, the decomposition flask was suspended in a beaker of water. By heating the water the contents

<sup>1</sup> Am. Chem. Jour., 19, 410 (1897).

of the flask could be heated and it was also possible to run cold water in and out of the beaker, thus cooling the contents of the flask.

In making a determination fifteen grams of the couple were placed in the decomposition flask and the air in the apparatus replaced by dried hydrogen. The gas storage pipette was filled with mercury and the pressure of the hydrogen in the flask, which was above atmospheric pressure, was brought to the latter pressure by turning the burette stopcock quickly. The bromoform solution was then placed in the burette and run into the flask. The hydrogen displaced by the solution passed into the storage pipette. The temperature of the contents of the decomposition flask was raised if necessary to start the reaction and was kept as near  $35^{\circ}\text{C}$  as possible. This was usually very difficult if not impossible; however the temperature was somewhere within the limits of  $30^{\circ}$  and  $40^{\circ}$ , save in exceptional cases. The pressure in the flask during the reaction was kept slightly below atmospheric pressure. In this way, in the unlikely case of slight leaks, no methane or acetylene would be lost and any air leaking in except in excessive amounts would have no influence on the results. After a sufficient amount of gas had been evolved, by which time the reaction took place only very slowly, the bromoform solution was cooled to room temperatures. This practically caused the reaction to stop. Absolute alcohol was now run in by means of the burette until all the gas in the flask was displaced. The gas in the storage pipette was analyzed in two portions. In the first portion the methane was determined; in the second the acetylene was determined.

To determine the methane a known amount of the gas was passed into a pipette containing an ammoniacal cuprous chloride solution, then into a pipette containing potassium hydroxide, and finally into a pipette containing concentrated sulphuric acid. The gas now consisted of hydrogen, methane, bromoform vapor, and traces of alcohol vapor. This gas was passed into a combustion pipette and the hydrogen and

methane determined. The amount of hydrogen in the apparatus at the start could be found by adding the volume of the bromoform solution used and the volume of absolute alcohol added. If the hydrogen by the two methods agreed within the limits of experimental error the amount of alcoholic vapor mixed with the hydrogen, methane, and bromoform vapor must be slight. This was found to be the case.

It was found to be impossible to determine the acetylene by noting the decrease in volume of the gas in the ammoniacal cuprous chloride pipette as the contraction was far larger than the amount of acetylene present. At one time it was believed that formic aldehyde vapor was present because colored rings were obtained with resorcinol and also with gallic acid tests. However, blank tests in the presence of zinc bromide, alcohol and water gave similar results.

The second portion of gas was passed into a small flask containing ammoniacal cuprous chloride and the copper acetylide formed was filtered and washed, first with dilute ammonium hydroxide and then with water. The precipitate was partially decomposed by means of hot hydrochloric acid, the small amount undissolved was heated to decompose it into copper and carbon and the copper dissolved with a little nitric acid. The solution containing the copper from the copper acetylide was made slightly alkaline with sodium hydroxide and boiled in order to precipitate the hydrated cupric oxide. This precipitation was carried on in a porcelain dish to avoid contamination with silica. After filtration the precipitate was washed, dried, ignited and weighed. This method of determination gives slightly high results, due to the adsorption of sodium salts by the cupric oxide.

Acetylene is somewhat soluble in alcohol or bromoform, so that some acetylene remained in the solution in the decomposition flask. In order to determine the amount, the solution was filtered and washed once with alcohol. This operation was carried on as rapidly as possible to avoid loss of acetylene. The acetylene in the filtrate was distilled in a current of hydrogen and passed into some ammoniacal cuprous chloride solu-

tion. Together with the copper acetylide, there was precipitated some nearly black substance which on ignition either volatilized or was oxidized. The copper in the copper acetylide was determined as before.

In the following tabulation of data:

- V = volume of bromoform solution used
- V<sub>1</sub> = volume of gas taken for the determination
- V<sub>2</sub> = volume of gas from the absorption pipettes
- V<sub>3</sub> = volume of oxygen added plus V<sub>2</sub>
- V<sub>4</sub> = volume after combustion
- V<sub>5</sub> = volume of CO<sub>2</sub> = volume of CH<sub>4</sub>
- V<sub>6</sub> = total volume of CH<sub>4</sub>, corrected
- V<sub>7</sub> = total volume of C<sub>2</sub>H<sub>2</sub>, corrected
- H = height of the barometer in millimeters
- T = room temperature
- W<sub>1</sub> = weight of CuO corresponding to the acetylene in the gas evolved.
- W<sub>2</sub> = weight of CuO corresponding to the acetylene dissolved in the solution. By percent acetylene is meant the volume of acetylene in the total CH<sub>4</sub> + C<sub>2</sub>H<sub>2</sub> found.

The solution first used was solution A, which consisted of one part by weight of bromoform and four parts by weight of absolute alcohol. Appreciable action of the couple on this solution began at about 20° C. At a temperature of 35° C, the action was fairly rapid for a short time, then becoming rather slow.

SOLUTION A

Determination of CH<sub>4</sub>

V	V <sub>1</sub>	V <sub>2</sub>	V <sub>3</sub>	H	T
30	88.2	77.6	160.4	740	20°
36	72.3	63	145.3	740	22.5
V <sub>4</sub>	V <sub>5</sub>	V <sub>6</sub>	V <sub>7</sub>	H	T
38.65	26.65	36.2	740	20°	
48.6	22.5	34.9	740	22.5	

Determination of C<sub>2</sub>H<sub>2</sub>

V <sub>2</sub>	W <sub>1</sub>	W <sub>2</sub>	V <sub>7</sub>	Percent C <sub>2</sub> H <sub>2</sub>
44	0.0058	0.0238	5.8	13.8
52.5	0.0064	0.0226	5.32	13.2

The solution next used consisted of one part of bromoform and three parts of absolute alcohol.

SOLUTION B					
Determination of CH <sub>4</sub>					
V	V <sub>1</sub>	V <sub>2</sub>	V <sub>3</sub>	H	T
30	71.8	62.9	135.5	741	21°
Determination of C <sub>2</sub> H <sub>2</sub>					
V <sub>4</sub>	V <sub>5</sub>	V <sub>6</sub>	V <sub>7</sub>	Percent C <sub>2</sub> H <sub>2</sub>	
37.6	22.2	36.5	741	21°	
V <sub>1</sub>	W <sub>1</sub>	W <sub>2</sub>	V <sub>7</sub>	Percent C <sub>2</sub> H <sub>2</sub>	
58.5	0.0077	0.0274	6.26	14.7	

As only a small increase of acetylene was found, a much stronger solution was used. Solution C consisted of four parts of bromoform and five parts of absolute alcohol.

An appreciable reaction of the couple on this solution began as low as 15° C and in a short time became very violent. The decomposition flask was cooled immediately the reaction began but it was very difficult to keep the temperature of the contents of the flask below 40° until after the violence of the reaction had decreased considerably.

SOLUTION C					
Determination of CH <sub>4</sub>					
V	V <sub>1</sub>	V <sub>2</sub>	V <sub>3</sub>	H	T
25	69.1	55.4	113	748	24°
25	70.1	56.8	112.5	741.5	25
V <sub>4</sub>	V <sub>5</sub>	V <sub>6</sub>	V <sub>7</sub>	Percent	
33	14.1	22.6	748	24°	
29	12.4	17.6	741.5	25	
Determination of C <sub>2</sub> H <sub>2</sub>					
V <sub>1</sub>	W <sub>1</sub>	W <sub>2</sub>	V <sub>7</sub>	Percent	
53.2	0.0118	0.0184	6.41	22.1	
41.5	0.0066	0.0188	5.15	22.6	

These results show an increase of about 9 percent acetylene as compared with those obtained with solution A. By using more concentrated solutions of bromoform without doubt far greater yields of acetylene would be obtained. Stronger

solutions were not used owing to the violence of the reaction which made temperature regulation very difficult.

The influence of water on the yield of acetylene was next investigated. Solution D consisted of one part bromoform, one part of water, and four parts of absolute alcohol.

SOLUTION D

Determination of  $\text{CH}_4$

V	$V_1$	$V_2$	$V_3$	H	T
30	71.1	60.3	121.2	742	22°
30	77.6	65.7	141.1	746	24

$V_4$	$V_5$	$V_6$	H	T
36.6	12.4	17.8	742	22°
39.4	20.6	29.9	746	24

Determination of  $\text{C}_2\text{H}_2$

$V_1$	$W_1$	$W_2$	$V_1$	Percent $\text{C}_2\text{H}_2$
41.3	0.0090	0.0308	7.78	30.5
47.2	0.0234	0.0323	13.24	30.7

The addition of an amount of water equal to the amount of bromoform to solution A considerably more than doubles the yield of acetylene. This result was rather unexpected as Gladstone and Tribe state, regarding the action of the zinc-copper couple on bromoform in the presence of water: "At ordinary temperature, action takes place very slowly, methane being evolved and zinc bromide and oxybromide formed. At 60° the action is, of course, more rapid and the methane is found mixed with a little acetylene."

Since the couple acts on water with the evolution of hydrogen while with absolute alcohol there is no appreciable reaction it might be thought that water added to the bromoform solution would tend to reduce the  $\text{CH}$  to  $\text{CH}_4$  with a greater yield of methane. On the other hand, when water and alcohol are mixed there is an evolution of heat and, therefore, the alcohol would probably be in a more stable state. Water added to a mixture of bromoform and alcohol causes the bromoform to be less soluble, and, therefore, the

bromoform is in a less stable state. Accordingly, a greater yield of acetylene in the presence of water might be expected.

In order to determine whether the increase of acetylene was due to the specific nature of the water, an equal amount of benzene was substituted for the water. Solution E consisted of one part of bromoform, and one part of benzene, and four parts of absolute alcohol. The benzene vapor in the gas evolved was removed by passing the gas into a pipette containing an ammoniacal solution of nickel cyanide.

SOLUTION E					
Determination of $\text{CH}_4$					
V	$V_1$	$V_2$	$V_3$	H	T
30	74.7	65.5	137.8	735	26°
30	71.5	61.5	124.4	743	23
$V_4$	$V_5$	$V_6$			
47	18.8	26.1	735	26°	
29.9	17.5	25.8	743	23	
Determination of $\text{C}_2\text{H}_2$					
$V_1$	$W_1$	$W_2$	$V_2$	Percent $\text{C}_2\text{H}_2$	
42.9	0.0077	0.0108	4.49	14.7	
44.2	0.0071	0.0140	4.58	15.1	

These results are somewhat higher than those obtained with solution A but easily show that the increased yield of acetylene in the presence of water was due to the specific nature of the water. Further proof of this is given by the work of Cazeneuve<sup>1</sup> who obtained good yields of acetylene by adding bromoform and a solution of  $\text{CuCl}_2$  to zinc dust. The resulting zinc-copper couple decomposes the bromoform. It seems rather strange, in view of this, that Gladstone and Tribe obtained only a little acetylene mixed with the methane.

The action of zinc-copper couples prepared by different methods is quite probably not exactly the same. Gladstone and Tribe obtained very much less acetylene by the decomposition of bromoform by means of zinc foil than by means of the zinc-copper couple. It is evident that a couple containing

<sup>1</sup> Comptes rendus, 97, 1371 (1883).

one amount of zinc would act somewhat differently from a couple containing a different amount of zinc.

It is quite possible that Gladstone and Tribe's loss of CH was partially or even wholly due to acetylene remaining behind dissolved in the decomposition solution. They say nothing of this possibility or of any boiling of the solution which would remove dissolved acetylene.

Berthelot, in 1866, found that on heating pure acetylene in a curved tube over mercury to a temperature sufficient to soften hard glass, the volume of the gas decreased and at the same time tarry products made their appearance. In one experiment, 97 percent of the original acetylene had disappeared, leaving only 3 percent unchanged, while almost all the carbon and hydrogen of the acetylene were found in the liquid and solid products of the reaction. These latter consisted of various polymers of acetylene, such as benzene, which was the chief product, styrolene, etc.

Iron carbide is not the only carbide yielding more than one hydrocarbon on decomposition. Moissan prepared  $CeC_2$ ,  $LaC_2$ ,  $YtC_2$ , and  $ThC_2$ , which are decomposed by water, giving mixtures of acetylene and methane. Moissan also prepared the definite well-crystallized compound  $Ur_2C_3$ , which, on decomposition by water, not only gives a gaseous mixture of methane, acetylene, and hydrogen, but also amounts of liquid and solid hydrocarbons corresponding to two-thirds of the carbon contained in the carbide. In accordance with Campbell's view of this behavior, it would seem necessary to assume the existence of several series of uranium carbides. All these uranium carbides would have to be isomorphous and be present in such amounts as to give uranium and carbon contents agreeing with the formula  $Ur_2C_3$ .

To account for the products ethane, ethylene, butylene, and dibutylene, which are obtained by the decomposition of iron carbide by hydrochloric acid, Campbell believed it not unreasonable to assume the existence of a series of ferro-carbons analogous to the olefine series of hydrocarbons. Yet here is a carbide,  $CHBr_2$ , which on decomposition gives



the direct products methane and acetylene in varying amounts depending on the conditions, and the indirect products benzene, styrolene and naphthalene. It is not necessary or even possible to assume the existence of a series of bromoforms in order to account for the products obtained by the decomposition of bromoform. This being the case, it appears unnecessary to assume the existence of a series of ferro-carbons analogous to the olefine series of hydrocarbons, especially in the absence of anything directly tending to prove their existence.

A simpler and, at present, apparently more probable explanation for the products obtained by the decomposition of iron carbide by hydrochloric acid, is that the first product of the decomposition are hydrogen, ferrous chloride and  $\text{CH}_2$ . This  $\text{CH}_2$  is liberated in the so-called nascent state and in the very probable presence of catalytic agents. It is also incapable of existing alone. Under these conditions it polymerizes into  $\text{C}_2\text{H}_2$ ,  $\text{C}_3\text{H}_4$ ,  $\text{C}_6\text{H}_8$ , etc.

Some of the  $\text{C}_2\text{H}_2$  formed is reduced to  $\text{C}_2\text{H}_6$ . The above explanation for the products of the decomposition of iron carbide seems also applicable to the products obtained by the decomposition by water of the carbides  $\text{CeC}_2$ , and  $\text{LaC}_2$ ,  $\text{YfC}_2$ ,  $\text{ThC}_2$  and  $\text{U}_2\text{C}_3$ . In the case of bromoform, we evidently have  $\text{CH}$  set free which polymerizes to  $\text{C}_2\text{H}_2$  or is reduced to  $\text{CH}_4$ , depending on the conditions of the experiment. Special experiments would be necessary to show whether, or how, the iron carbides could be decomposed so as to yield methane or acetylene as the chief gaseous products. This interesting problem does not come within the scope of this investigation which merely proves that it is not safe to deduce the molecular weight of a carbide from its hydrocarbon decomposition products.

This investigation was undertaken at the suggestion of Professor Bancroft, to whom the author is greatly indebted for the many very valuable suggestions given during the research.

*Cornell University*

## ON A DEVICE FOR MEASURING TRANSPARENCY

BY M. M. FELDSTEIN

Since in the preceding article<sup>1</sup> only a general description of the Friedburg absorptiometer was intended, no attempt was made to give an exact theory of the instrument. As it proved, however, useful in measurements exacting a certain degree of accuracy, we consider it expedient to give a few details.

The instrument is represented in the following diagram:

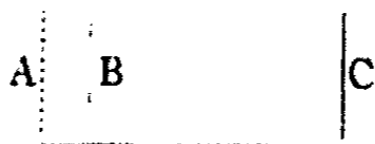

A represents the opaque object, B the polarizer, and C the analyzer.

Denoting by  $E$  the intensity of the light transmitted by the opaque body, by  $I$  the intensity of the light transmitted by the analyzer, and by  $\varphi$  the angle through which the analyzer is turned from the initial position of maximum light, we have by the Law of Malus:

$$I = E \cos^2 \varphi \quad (1)$$

In comparing the transparency of two objects, each time we turn the analyzer to a point where further darkening is imperceptible. If we denote by subscripts <sub>1</sub> and <sub>2</sub> respectively the quantities referring to each object, we obtain from the preceding condition and from (1)

$$E_1 \cos^2 \varphi_1 = E_2 \cos^2 \varphi_2 \quad (2)$$

During the experiment the intensity ( $S$ ) of the source of light remains constant, that is

$$S_1 = S_2 \quad (3)$$

<sup>1</sup> L. H. Friedburg, "On a Device for Measuring Transparency:" Jour. Phys. Chem., 14, 84 (1910).

Now dividing both sides of (3) by  $E_1 \cos^2 \varphi_1$  and  $E_2 \cos^2 \varphi_2$  respectively, we obtain:

$$\frac{S_1}{E_1} : \frac{S_2}{E_2} = \cos^2 \varphi_1 : \cos^2 \varphi_2$$

But the ratio of the intensities of the impinging and transmitted light is the definition of transparency. We may, therefore, state the law of the instrument in the following way:

The transparencies of two objects are in the ratio of the squares of the cosines of the angles through which the analyzer is turned from the position of maximum light, to that where further darkening is imperceptible, the intensity of the source of light remaining constant.

*College of the City of New York*

## NEW BOOKS

*Traité de Radioactivité.* By Mme. P. Curie. Vol. I. 17 × 26 cm; pp xiii + 426; Vol. II, pp. 548. Paris: Gauthier-Villars, 1910. Price: 30 francs.

—The subject is presented under the following heads: ions and electrons; methods of studying and measuring radioactivity; radioactivity of uranium, thorium and minerals; the new radioactive substances; short-term radioactivity, induced radioactivity, etc.; radioactive gases or emanations; induced radioactivity; theory of the transformations of radioactive substances; nature of the radiations; different phenomena noted in presence of radioactive substances; evolution of heat from radioactive substances; uranium and its descendants; radium and its descendants, polonium; thorium and its descendants; actinium and its descendants; production of radium—ionium and the relations between the radioactive substances; radioactivity of the earth and the air.

Mme. Curie accepts Rutherford's theory of the gradual degradation of the radioactive substances. On p. 136 exception is taken to the loose use of the term radioactivity. Phosphorus emits light, and ionizes the surrounding air to some extent; but it should not be considered as radioactive in the sense in which we apply the word to uranium or thorium because the phosphorus oxidizes and because the ions produced are very much larger than those produced by the Röntgen or Becquerel rays. The hydration and dehydration of quinine sulphate is not an atomic property of anything and therefore the effects produced should not be classed as radioactive. Zinc gives out negative ions when exposed to ultraviolet light; but Mme. Curie will not class zinc among the radioactive metals. She bars incandescent substances even though they emit ultraviolet rays of very short wave length. The power of affecting a photographic plate is not accepted as a criterion of radioactivity.

*"The substances which are called radioactive are those which emit Becquerel rays spontaneously, the emission being dependent on definite kinds of atoms. The spontaneity of the emission and its atomic character are the essential characteristics of radioactivity.*

*"The radioactivity of the compounds of uranium and thorium seems to be permanent. There are substances known, however, which come under the preceding definition of radioactive substances and which appear not to have a permanent radioactivity. Polonium is a case in point. It has not yet been isolated but mixtures of it with inactive substances have been obtained. The radioactivity of these mixtures disappears gradually and is a function of the time. We cannot therefore consider the permanency of the radioactivity as an essential characteristic. According to the modern theories of radioactivity, we nevertheless consider radioactivity as an inseparable property of the substance displaying it. If the radioactivity disappears we conclude that the substance itself has disappeared. From this point of view the radioactive elements are composed of instable atoms which are destroyed by emitting Becquerel rays, thus giving rise to other atoms with a lower atomic weight. The radioactivity is more permanent, the lower the rate of decomposition."*

The chapter on the nature of the radiations takes up about half the second

volume. The results as to the effect of temperature on radioactivity seem a bit contradictory. P. Curie found no change when the radioactive substance was cooled to the temperature of liquid air. This has been confirmed by Dewar for a range of temperature from  $+150^{\circ}$  to  $-255^{\circ}$  (liquid hydrogen). At high temperatures, other results are obtained, p. 214.

"If radium is heated to a high temperature it continues to be radioactive. When barium chloride, containing radium, has just been melted at about  $800^{\circ}$ , it is radioactive and luminous. A prolonged heating at a high temperature causes a temporary decrease in the radioactivity of the substance. The decrease is considerable and may amount to 75 percent of the total radiation: the relative decrease being less for the rays which are readily adsorbed than for the more penetrating ones, these latter being pretty thoroughly cut out by heating. In course of time the radiation assumes the intensity and characteristics which it had before the heating, the time necessary being about a month."

In the chapter on the different phenomena noted in presence of radioactive substances, Mme. Curie discusses the phenomena of luminescence, the ionization of gases, the decomposition of water, etc.

Wilder D. Bancroft

**Nephritis.** By Martin H. Fischer. 14 × 20 cm; pp. 198. New York: John Wiley & Son, 1912.—The subject is classified under the headings: the albuminuria; the morphological changes in the kidney; the disturbances in secretion in nephritis; on the treatment of nephritis.

The term nephritis is used to mean the non-purulent inflammations of the kidney. The general conclusion, to which the author comes, is stated early in the book, p. 2. "All the changes that characterize nephritis are due to a common cause—the abnormal production or accumulation of acid in the cells of the kidney. To the action of this acid on the colloidal structures that make up the kidney are due the albuminuria, the specific morphological changes noted in the kidneys, the associated production of casts, the quantitative variations in the amount of urine secreted, the quantitative variations in the amount of dissolved substances secreted, etc."

On p. 5 the author states his conviction that "albuminuria results whenever conditions are offered in the body which permit the solid colloidal membrane that separates the blood from the urine to go into solution in the urine."

The passage on the physicochemical structure of the kidney, p. 5, is worth quoting in full.

"The system that is involved in the production of urine consists in the main of three parts or phases—the blood, the urinary membrane, and the urine.

"The blood consists of a liquid portion in which are floating various nucleated and non-nucleated cells. These cells are fairly solid colloid structures, that in their general properties are often said to be 'jelly-like,' a characterization that really fits them very well, for in their general biological behavior they are not unlike a stiffened gelatine, for example, but the liquid portion of the blood is also essentially colloid in character, only the colloids here are in a fluid state. It corresponds, say, with a 'solution' of gelatine or of albumin or globulin. Present in both the liquid and the solid portions of the blood are normally a number of salts and various non-electrolytes which play an important part in maintaining the normal state of the colloids that are found here. For the

sake of brevity we will ordinarily, in this paper, refer to the whole blood as a single phase, and so as one of the phases making up the ordinary secretory system. We need not especially emphasize the fact that taken strictly this is not correct; there really exist several phases within the blood itself.

"Under the urinary membrane we will include all the structures that lie between the blood on the one side and the urine on the other. The urinary membrane as we will use the term is made up of all the different cells that are found between the blood on the one side and the urine on the other, together with their various intercellular substances. The whole constitutes a fairly firm structure to which we may again apply the term 'jelly-like.' In the terms of physical chemistry this membrane consists of a mixture of various emulsion colloids in the solid or gel state. We find present here also, as in all the body tissues, various electrolytes and non-electrolytes. This membrane has not the same composition everywhere. Not only does histological evidence show a striking difference in the character of the cells that make up the different parts of the urinary membrane (different cell structure in the glomeruli, convoluted and straight tubules, etc.), but so does physiological evidence (adsorption of dyes). So this membrane also is itself composed of several phases, but unless specially noted we will simply refer to the whole as the second phase of our secretory system.

"The third phase of our secretory system is formed by the urine. As is well known this is, under normal conditions, an aqueous solution of various crystalloids—electrolytes and non-electrolytes. Colloidal material is present in only very small amount and consists of that trace of albumin already referred to that is found in normal urine, together with some mucin, etc., derived from the urinary tract. When the urine becomes albuminous, as in nephritis, this colloid content rises. As we have said, this is because in albuminuria the albumin of the urinary membrane goes into 'solution' in the urine: the solid colloidal urinary membrane (a gel) becomes a sol."

The experiments on the effect of basket ball, p. 44, are interesting as are also those on cloudy swelling, p. 77, and those, p. 88, on the voluntary production of hyaline or of granular casts.

On p. 53 we read that "albuminuria is the constant *accompaniment of salt starvation*, be this a complete salt starvation or only such a partial one as is induced by completely eliminating the sodium chloride from the food. Under this same heading is to be classed the albuminuria consequent upon the *excessive consumption of water* low in salts. The latter washes the salts out of the body and so leads indirectly to the same state as that induced by a lack of salts in the diet. The effect of a salt-free diet is twofold. In the first place it leads to the accumulation of acids in the tissues. Other things being equal, we have on this basis alone therefore a reason for the albumin going into solution (and so an albuminuria) when salts are withheld from the diet. But the salts act in yet another way. We found, in detailing the experiments on the solution of fibrin and of gelatin in acids, that this tendency of the colloidal gels to go into solution in a given concentration of acid is greatly inhibited through the presence of all salts, even neutral salts incapable of an effect which might be construed as due to a mere neutralization of the acid. Through the withdrawal of salts from the tissues, whether by salt starvation or through leaching these out with water,

we favor therefore the tendency of the proteins to go into solution in two ways: not only do we render possible an abnormal production or accumulation of acids in the tissues, but we take away at the same time the effect of the salts in reducing the tendency of the colloids to go into solution in such acids as may be abnormally present, or those which, like carbon dioxide, are normally produced in the tissues."

The reviewer is not qualified to pass upon medical questions but the author has certainly written an interesting book. *Wilder D. Bancroft*

**Die Kolloide in Biologie und Medizin.** By *H. Bechhold*. 16 X 23 cm; pp. xii + 408. Dresden: Theodor Steinkopff, 1912. Price: 14 marks.—The author begins with seven chapters on the general properties of colloids; then come five chapters on the biocolloids, the sub-heads being carbohydrates, lipoids, albuminoids, foods and beverages, enzymes, serums. The third section of the book deals with the organism as a colloidal system, while the last part of the book is devoted to toxicology and pharmacology.

There are a great many interesting things in the book, such as: centrifuging collargol or caseine, p. 5; the structure of jellies, p. 9; ultra-filtration of emulsions, p. 15; adsorption of fatty acids, p. 27; displacement of adsorbed enzymes, p. 27; dyeing of naphthalene, p. 29; composition of blood cells and of serum, p. 32; separation of albumoses, p. 35; molecular weight of albumin, p. 38; diffusion of colloids into colloids, p. 50; membranes permeable to fats, p. 55; ageing of gelatine, p. 67; antagonism of different cations, pp. 75, 221, 352; coagulation of white of egg, p. 75; the dissolving of agar-agar, p. 125; action of proteids in increasing the solubility of salts, p. 136; cash value of better cooking, p. 153; ageing of condensed milk, p. 159; formation of wood, p. 229; excitation by ions, p. 271; resorption in the intestines, p. 294; emulsification of olive oil with albumin, p. 326; positive and negative ferric oxide, p. 358; adsorption and fixation of mercury, p. 371; technique of staining tissues, p. 387.

The author has made extensive use of Fischer's hypothesis as to the non-existence of cell walls. Attractive though this hypothesis is in some respects, it is not deemed by the biologists to be in accord with facts. *W. D. B.*

**Leçons sur les Hypothèses cosmogoniques.** By *H. Poincaré*. 16 X 25 cm; pp. xxv + 279. Paris: A. Hermann et Fils, 1911. Price: \$1.25.—The subject is discussed under the following heads: Kant's hypothesis; Laplace's hypothesis; Faye's hypothesis; the hypothesis of du Ligondès; See's hypothesis; theory of G. H. Darwin; the source of the solar heat; theories of Lockyer, Schuster and Arrhenius; the Milky Way and the theory of gases; See's explanation of the formation of spiral nebulae; Belot's hypothesis. The author's own summing up of the relative status of the different hypotheses is to be found in the preface.

"After this sketch, people doubtless expect me to draw some conclusions and that embarrasses me. The more one studies the problem of the origin of the stars, the less one feels inclined to be dogmatic. Each one of the theories proposed is very satisfactory to a certain extent. Some account for certain facts admirably; others have a wider scope but are either somewhat more vague as to detail or give us a definiteness which is clearly illusory.

"If it were merely a question of the solar system, I should adopt Laplace's

old hypothesis. It needs very few changes to make it satisfactory. As there are a number of stellar systems, it is necessary to take a broader point of view, in which case the hypothesis of Laplace must either be abandoned completely or must be modified so as to be only a special case, applicable merely to the solar system, of a more general hypothesis which would apply to the universe and would account for each star being where and what it is.

"Our data are insufficient for this and there is still much to be done in the way of making observations. Do Kapteyn's two streams of stars really exist and are there others? What are the nebulae and especially what are the spiral nebulae? Are they at enormous distances outside of the Milky Way and are they themselves Milky Ways seen from far off? In spite of their spectra, is it theoretically impossible to resolve them into masses of true stars; must we accept Bohlín's measurements as to the parallax of the nebula of Andromeda and the conclusions which See draws from them that, while this celestial object is doubtless composed of suns, the suns are no larger than the asteroids between Mars and Jupiter? Is it possible to maintain that our solar system has developed from one of the types of nebulae with which we are familiar, the spiral, planetary, or annular for instance? We cannot attempt to answer this last question until we know more about the nature, distance and dimensions of the nebulae.

"There is one point which strikes everybody, the spiral form of certain nebulae. This occurs too often to be merely a matter of chance. Consequently any cosmogonic theory is incomplete which does not take account of this phenomenon and yet not one of them is satisfactory on this point, and the explanation which I once gave is no better than the others. We have as yet no final theory as to the development of the universe." *Wilder D. Bancroft*

**An Experimental Course of Physical Chemistry. Part I. Statical Experiments.** By James Frederick Spencer. 12 X 19 cm; pp. xiv + 228. London: G. Bell & Sons, 1911. Price: 3/6.—In the preface we read that "an experience of teaching physical chemistry, extending over several years, has shown the author that unless the student actually performs physico-chemical experiments and verifies physico-chemical laws for himself in the laboratory, he is apt to regard the subject from too academic a standpoint. He may become interested in its principles either for their own sake, or for the purpose of passing an examination, but he does not consider it necessary that he should concern himself with its practical side. This, obviously, can only lead to a very one-sided and incomplete conception of the subject. This work has been written, therefore, to provide the student of physical chemistry with a guide, which shall enable him to carry out for himself the simpler physico-chemical operations."

This sounds well; but will not stand examination. It is hardly to be believed that the author thinks that he has discovered the advantages of laboratory practice. The reviewer is not at all clear what the author has in mind when he refers to the practical side of physical chemistry. It would have been simpler and more interesting if the author had said frankly that he wished to write a book and that this was the book he had written.

The headings of the chapters are: interpretation of results; determination



of weight, volume and temperature; thermostats and constant temperature ovens; manipulation of gases; density; atomicity; molecular weights in solution; solubility; viscosity and surface tension; polarimetry; spectroscopy; refractivity; thermal measurements. *Wilder D. Bancroft*

**Gesammelte Werke.** By *Walther Ritz*. (*Publiées par la Société suisse de Physique.*) 16 × 25 cm; pp. xxii + 541. Paris: Gauthier-Villars, 1911. Price paper, 18 francs.—Walther Ritz was a young Swiss physicist who died in 1909 at the age of thirty-one. The few working years which this gave were even less actually owing to the fact that Ritz could only work at intervals during the last four or five years of his life. In spite of these handicaps the work done by Ritz was so brilliant that the Swiss Physical Society has decided very wisely to publish the collected works in a special volume.

The papers in this volume fall naturally into three groups: those dealing with series spectra; those with the theory of electrodynamics; and those dealing with the solutions of problems involving partial differential equations. It is a monumental record for one so young. *Wilder D. Bancroft*

**Le Mouvement.** By *J. Andrade*. 15 × 23 cm; pp. vi + 328. Paris: Felix Alcan, 1911. Price: 6 francs.—In the preface the author says:

"There are some general facts which are of importance to the study of the concepts of time or space and to the physical measurement of these values. These facts have been studied for a long time by philosophers and geometers; they must now become a part of all scientific professions and must be adapted to the needs of technical education, needs still scarcely understood in our school work; it has seemed to me that a realistic intuition might throw a new light on these facts, apparently as old as the world."

What the author has done is to present his subject as the work of individual men, sacrificing thereby something of polish; but gaining a good deal in interest. The four divisions of his subject are: number and extension, the concepts of geometry; motion and the concepts of force; the measurement of extensions; the mechanical measurements of time. *Wilder D. Bancroft*

**Untersuchung und Nachweis organischer Farbstoffe auf spektroskopischem Wege.** By *Jaroslav Formanek and Eugen Grandmougin*. 17 × 25 cm; pp. 164. Berlin: Julius Springer, 1911. Price: 10 marks.—The first volume was reviewed (13, 738) over two years ago. This first part of the second volume contains chapters on the handling of the spectroscope, on the spectroscopic study of dyes and on the spectroscopic investigation of mixtures of dyes by themselves, in fibers, or in foods and drinks. The authors classify the green dyes in six groups, giving the typical spectra for each group. They also give a list of the green dyes together with an account of the way in which they behave with the more common reagents. The same thing is done for the blue dyes except that they are classified in five groups instead of in six. *Wilder D. Bancroft*

## ON THE SOLUBILITY OF ACTINIUM EMANATION IN LIQUIDS AND IN CHARCOAL

BY G. HEVESY

In the determination of the solubility of radium emanation in water and in different organic liquids, various experimenters (v. Traubenberg, Himstedt, Mache, Hoffmann, Kofler, Ramstedt,<sup>1</sup> etc.) have employed the well-known statical method, agitating the liquid with air containing the emanation until complete partition of the emanation between the two phases had taken place, afterwards estimating the activity still present in the air and in the liquid. Since the life of radium emanation is very long in comparison with the time necessary for its distribution between the two phases, no difficulties are encountered in the employment of the above mentioned statical or "shaking method." Such, however, is not the case when determining the solubility of thorium emanation; the short period of this product, which scarcely amounts to a minute, renders it difficult to carry out the experiments. Since, however, a practically complete partition of thorium emanation between air and a little violently agitated petroleum takes place after 1½ minutes, that is to say, a period where 30 percent of the emanation originally present is available in the undecayed condition, Klaus<sup>2</sup> was still able to estimate the solubility of thorium emanation in water and in petroleum by the shaking method. The half-value period of actinium emanation amounts to only 3.9 seconds. If we agitate the air containing the latter with a liquid and assume that the equilibrium-partition requires, as in the case of thorium emanation, then after this period has elapsed only  $9 \cdot 10^{-8}$  times the original quantity of emanation is present. Consequently, as the possibility of determining

<sup>1</sup> v. Traubenberg: Phys. Zeit., 5, 130 (1904). Himstedt: Phys. Zeit., 5, 210 (1904). Mache: Wiener Be., 113, 1329 (190). Hoffmann: Phys. Zeit., 6, 337 (1905). Kofler: Phys. Zeit., 9, 6 (1908). Ramstedt: Le Radium, 8, 253 (1911).

<sup>2</sup> Klaus: Phys. Zeit., 6, 820 (1905).

the solubility of actinium emanation in liquids by the shaking method was precluded, a dynamical "flow method" was employed. The basis of this method is as follows:

If an air current carrying emanation be allowed to bubble through a liquid, a portion of the emanation is absorbed by the latter and the diminution in activity of the air current affords a means of measuring the absolute quantity of emanation. In comparison with the shaking method, in which the maximum contact is aimed at, every endeavor is made to entirely avoid this in the method under discussion, and to permit only absorption and diffusion. Two processes take place, the first of which we assume to be absorption occurring instantaneously at the limiting surface, and the second a diffusion which can be expressed numerically.

This consideration is, however, only necessary in the quantitative determination of the solubility. In the case of the qualitative determination of solubility which we shall now discuss, both convection and diffusion may be equally active assuming, of course, that the relative external conditions are the same in all cases.

#### **The Absorption of Actinium Emanation by Different Liquids**

If an absorbent liquid be placed between the source of the actinium emanation and the ionization chamber of an electroscope it is equivalent to prolonging the path of the emanation, or the time which the emanation would require to pass from its source into the ionization chamber. If the observed activity in the case of a non-absorbent liquid is  $Ie^{-\lambda t}$  (where  $t$  is the time required for the emanation to reach the ionization chamber), it would be  $Ie^{-\lambda t'}$  in the case of an absorbent liquid, and  $Ie^{-\lambda t}$  and  $t'$ , respectively would give a qualitative measure of the solubility. Table 1 shows the activity observed after the passage of a current of air containing actinium emanation through a layer of liquid 3 cm high. The values are means of series of 5 concordant determinations and refer to rates of flow of 0.12, 0.15 and 0.20 cm

per second at the ordinary temperature and were estimated with the aid of the emanation electroscope described further on.

TABLE I

Velocity of flow, cm per sec.	0.12 Activity	0.15 Activity	0.20 Activity
Aqueous KCl solution saturated at 18° C	5.5	21.2	60.5
Conc. H <sub>2</sub> SO <sub>4</sub>	3.5	19.3	58.0
Water	3.0	16.4	52.5
Ethyl alcohol	1.8	14.0	43.5
Amyl alcohol	0.8	3.2	29.8
Acetone(?)	—	—	28.4
Benzaldehyde	—	2.9	22.8
Benzene	—	2.2	22.5
Toluene	—	2.0	16.5
Petroleum	—	1.7	9.2
Carbon disulphide	—	—	3.0

In this table the value given for acetone has not the same degree of certainty as the other figures, since a considerable quantity of acetone evaporated in the course of one minute from the washing flask into the ionization chamber and impaired the sulphur insulation of the electroscope. This deterioration of the insulation, which was also observed after some time in the experiments carried out with benzene and carbon disulphide (and which probably resulted from the formation of a relatively good conducting sulphur solution on the surface of the insulation) could be rendered abortive by allowing a rapid current of dry air to sweep through the electroscope.

In Table 2 the liquids are tabulated, in order of increasing absorption power for radium, thorium and actinium emanations, respectively according to measurements made by v. Traubenberg,<sup>1</sup> Boyle,<sup>2</sup> Ramstedt<sup>3</sup> and the author.

<sup>1</sup> v. Traubenberg: Loc. cit.

<sup>2</sup> R. W. Boyle: Bulletin of the Macdonald Phys. Build. No. 1, 52 (1910).

<sup>3</sup> Ramstedt: Loc. cit.

TABLE 2

Absorptive power for radium emanation (Ramstedt)	Absorptive power for thorium emanation (Boyle)	Absorptive power for actinium emanation (Author)
Aqueous salt solution	Aqueous salt solution	Aqueous salt solution
Water	Sulphuric acid	Sulphuric acid
Ethyl alcohol	Water	Water
	Ethyl alcohol	Ethyl alcohol
		Amyl alcohol
Acetone		Acetone
Benzene		Benzene
Toluene		Toluene
Petroleum (v. Traubenberg)	Petroleum	Petroleum
Carbon disulphide		Carbon disulphide

The solubility of various gases in organic liquids has been recently studied by MacDaniel<sup>1</sup> who found that the order of the absorptive powers of the liquids was quite as dependent on the characteristics of the gases absorbed as on the nature of the absorbent media. Only when dealing with similar gases can the same order of the series of liquids be expected.

In Table 2 we see that the order of the liquids arranged according to their absorptive powers, for the emanations in question, is identical in all three cases. From this we may conclude that these three emanations are chemically closely related. Consequently, as radium emanation is known to belong to the "inert" group of gases, we must include thorium and actinium emanations in the same category.

#### Experimental

In all the experiments about to be described the source of actinium emanation used was about 0.05 gram of an actinium preparation wrapped in tissue paper and placed in a glass tube. The samples of this preparation, which Professor Rutherford kindly placed at my disposal, had, according to Boltwood,<sup>2</sup> an activity equivalent to approximately 20,000

<sup>1</sup> Jour. Phys. Chem., 15, 608 (1911).

<sup>2</sup> Proc. Roy. Soc., 85 A, 77 (1911).

times the uranium standard. If air was allowed to pass through the glass tube (*d* in Fig. 1) containing the actinium, the air carried on the emanation; a portion of the latter was absorbed while flowing through the absorbent liquid contained in (*e*), while the rest passed into the ionization chamber of the electroscope (*g*), the accompanying air current traversing the bubble-counter (*h*) after leaving the ionization chamber. A very regular air current was supplied from a cylinder (*a*) filled with air at 150 atmospheres. In order to dry the air completely a washing flask (*b*) containing sulphuric acid, and a tube (*c*) filled with phosphorus pentoxide, were employed. Since the initial emanation content of the air current was rather greater than that in the succeeding steady state, air was allowed to pass through the tube containing the actinium for a period of thirty minutes before each experiment.

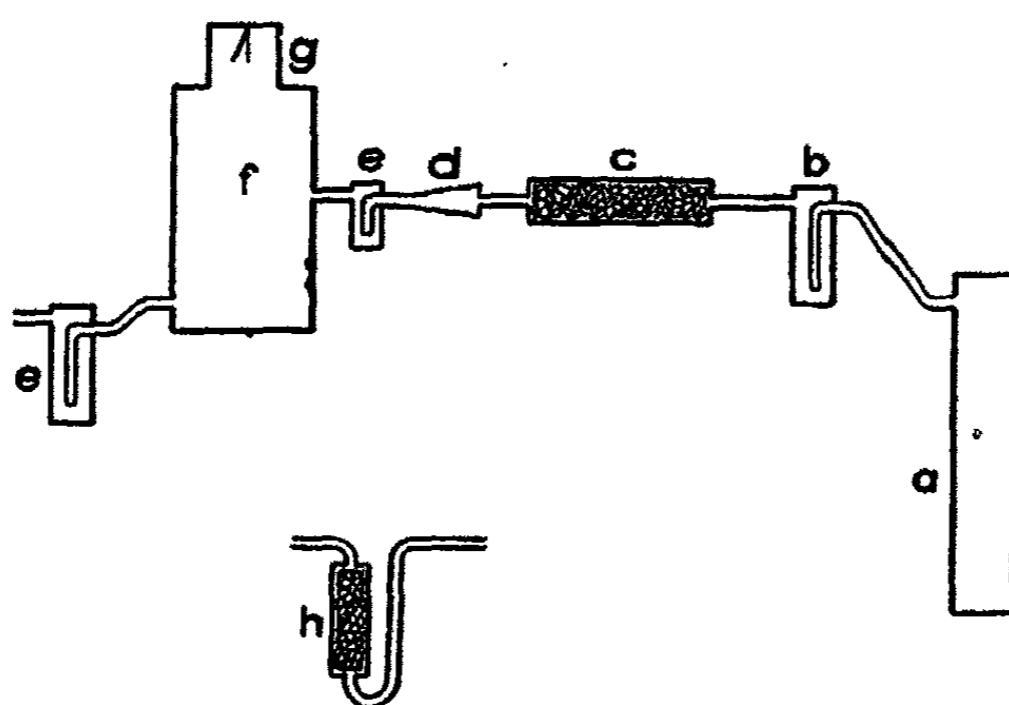

Fig. 1

The emanation electroscope employed consisted of a cylindrical ionization chamber (*f*) 7.2 cm in diameter and of 500 cm capacity. It carried a small closed copper chamber, fitted with two mica windows, and the gold leaf which was attached to a rod passing through the sulphur insulation 8 cm into the ionization chamber.

It was found more satisfactory to measure, not the activity of the active deposit in the ionization-chamber, but that of the emanation, and afterwards to deduct the activity corresponding to the active deposit. This latter was determined after each experiment, immediately after interrupting the air current bearing the emanation; first, however, allowing 40 seconds to elapse, after which time the emanation present in the ionization chamber had decayed to 0.2 percent of its original value. In most of the experiments the correction necessitated by the presence of the active deposit was only quite small.

In a series of experiments with absorption vessels of different capacities, the same order of the absorptive powers of the liquids investigated for actinium emanation was always observed, whatever the dimensions of the absorption vessel used. It was also found that the quantity of emanation passing into the ionizing chamber was independent of the horizontal dimensions of the liquid, *i. e.*, of the diameter of the cylindrical washing flask, but that on the other hand, it was greatly influenced by the vertical dimension, *i. e.*, on the length of the column of liquid. On account of this discovery which, moreover, receives strong confirmation from the study of the solution phenomena of actinium emanation, special care was taken to always have the same height of column in comparative experiments with liquids.

#### **Determination of the Partition of an Emanation of Short Period between Air and a Liquid Phase**

Let us suppose a uniform air current carrying an emanation to flow through a vertical, narrow column of liquid, and consider the former as an air cylinder embedded in a concentric liquid cylinder. In the equilibrium state the emanation is distributed, in accordance with its partition coefficient, between the flowing air and the surrounding liquid film. We assume that this partition comprises two processes; in the first place there is an instantaneous partition between the gaseous phase and a very thin contiguous layer

of the liquid and then a slower diffusion process from this boundary layer to the interior of the liquid. The correctness of this assumption, to which we are led by physico-chemical consideration of the mechanism of reactions,<sup>1</sup> is directly confirmed experimentally by MacBain's<sup>2</sup> investigations, in the case of the absorption of hydrogen by charcoal. MacBain<sup>2</sup> succeeded in heavily charging a sample of charcoal with hydrogen in the form of a solid solution and at the same time in almost entirely freeing the surface from the absorbed hydrogen. Inversely, he also charged the surface alone with hydrogen and showed that while the surface condensation took place instantaneously the diffusion on the other hand required 12 hours.

Our assumption is rendered very probable by the fact that when an air current containing actinium emanation flows through our vertical liquid-cylinder, the equilibrium between the air phase and the limiting layer of the liquid establishes itself instantaneously. As will be seen below it does not concern us whether the limiting film of the liquid is identical with the molecular layer and has consequently a thickness of the order of magnitude  $10^{-7}$ , or whether it has a thickness of  $10^{-8}$  or  $10^{-9}$ . The second stage of the process, *viz.*, the slow diffusion of actinium emanation towards the interior of the liquid, would appear to prevent rapid attainment of equilibrium. We see, however, from the differential equation for the diffusion of radioactive substances, which is an extension of Fick's differential equation, that the process of diffusion, thanks to the very short period of actinium emanation, is confined to a very small distance from the limiting layer: the second portion of the process, therefore, consisting of the distribution of the emanation in the interior of the liquid by diffusion also takes place very rapidly.

Let us now consider the differential equation for the diffusion of radioactive substances and, in connection there-

<sup>1</sup> See Nernst: "Theoretische Chemie," Stuttgart, 1909. Freundlich: Kapillarchemie, Leipzig, 1908.

<sup>2</sup> McBain: Zeit. phys. Chem., 58, 481 (1910).



with, calculate the volume which actinium emanation can attain by diffusion. This latter we can derive from the term  $v_1$  of the equation  $\eta = \frac{A_1 v_2}{A_2 v_1}$  where  $\eta$  is the partition coefficient,  $A_1$  and  $A_2$  the quantities of emanation present in the two phases and  $v_2$  the volume of air (which can easily be determined), and  $v_1$  that of the "active" value of liquid. The last quantity, which is generally in such case most difficult to arrive at, can in our case easily be determined, thanks to the short period of actinium emanation.

The differential equation for the diffusion is, provided diffusion occurs only in one (in our case horizontal direction):

$$\frac{\partial c}{\partial t} = D \frac{\partial^2 c}{\partial x^2}$$

where  $c$  = concentration  
 $t$  = time  
 $x$  = distance  
 $D$  = diffusion constant

In the case of a radioactive substance of which the constant is the left-hand side of the equation takes an additional linear term equal to  $\lambda c$ , and we have accordingly

$$\frac{\partial c}{\partial t} = D \frac{\partial^2 c}{\partial x^2} - \lambda c.$$

In the equilibrium condition

$$\frac{\partial c}{\partial t} = 0$$

$$D \frac{\partial^2 c}{\partial x^2} = \lambda c.$$

Integration gives

$$C = P e^{-\sqrt{\frac{\lambda}{D}} x} + Q e^{+\sqrt{\frac{\lambda}{D}} x}$$

if  $x = \infty$

$$C = 0 \quad Q = 0$$

if  $x = 0$

$$C = C_0$$

from which follows (I)

$$C = C_0 e^{-\sqrt{\frac{\lambda}{D}} x}.$$

Provided that  $D$  and  $\lambda$  are known, we can calculate from equation (I) the concentration  $C$  pertaining to each value of

$x$  in terms of the concentration of the limiting layer. The values in question are given in column 3 of Table 3 for actinium emanation and in column 6 for thorium emanation.

TABLE 3

1 $x$ in cm	Actinium emanation		4 $x$ in cm	Thorium emanation	
	2 $x$	3 C in multiple of Co		5 $x$	6 C in multiple of Co
1	400	0	1	105	0
0.1	40	0	0.1	10.5	0.00001
0.02	8	0.000	0.08	8.40	0.0002
0.01	4	0.0183	0.05	5.25	0.005
0.005	2	0.135	0.04	4.20	0.015
0.0001	0.4	0.670	0.01	1.05	0.350
0.00005	0.2	0.819	0.005	0.53	0.595
0.00001	0.04	0.960	0.001	0.11	0.900
0.000001	0.004	0.996	0.001	0.011	0.990
0.0000001	0.0004	0.9996	0.00001	0.0011	0.999

$$D = 0.1 \text{ cm}^2 \text{ day}^{-1} \\ = 0.18 \text{ sec}^{-1}$$

$$D = 0.1 \text{ cm}^2 \text{ day}^{-1} \\ = 1.28 \cdot 10^{-2} \text{ sec}^{-1}$$

The diffusion constant of actinium emanation in liquids has not been determined experimentally here, but the value  $0.07 \text{ cm}^2 \text{ day}^{-1}$  has been found for the diffusion constant of radium emanation<sup>1</sup> in water, and since more rapid diffusion of actinium emanation in liquids might be expected in accordance with the more rapid diffusion in air,<sup>2</sup> we have therefore assumed for  $D$  the value  $0.1 \text{ cm}^2 \text{ day}^{-1}$ . (The influence of the possible error due to this assumption will be considered later.)

It will be seen from the figures in Table 3 and from Figs. 2 and 3 that the distance from the dividing surface of liquid air in which emanation is present in noteworthy quantity is about 0.01 cm. The "active" volume of two cylinders, one of which is the air-column having the radius  $r$ , and the other

<sup>1</sup> Wallstabe: Phys. Zeit., 4, 721 (1903).

<sup>2</sup> See Debierne: Le Radium, 4, 225 (1907). Chaumont: Le Radium, 6, 106 (1909). Russ: Phil. Mag., 22, 420 (1909).

the cylinder having the radius  $r_1 + r_2$ , where  $r_2$  is the above-mentioned layer-thickness 0.01 cm.

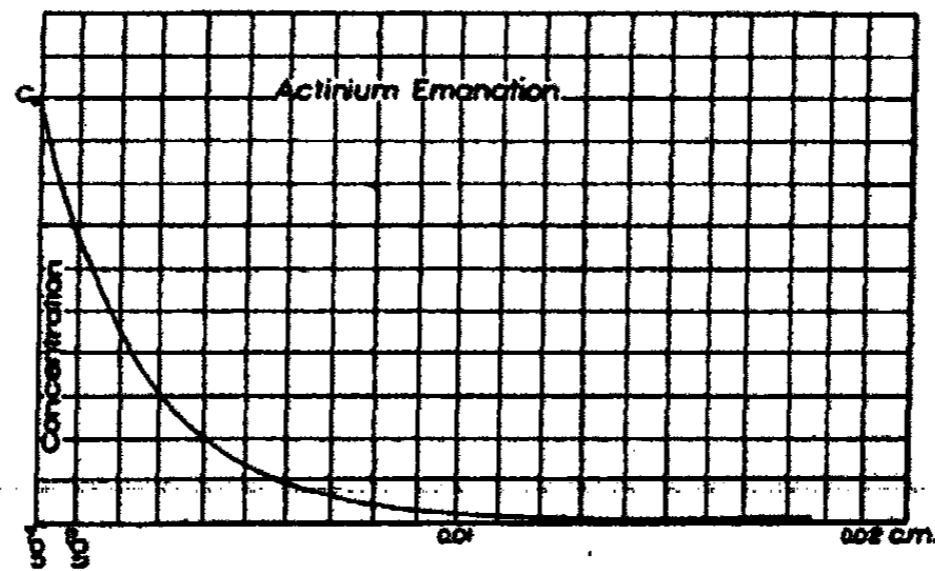

Fig. 2

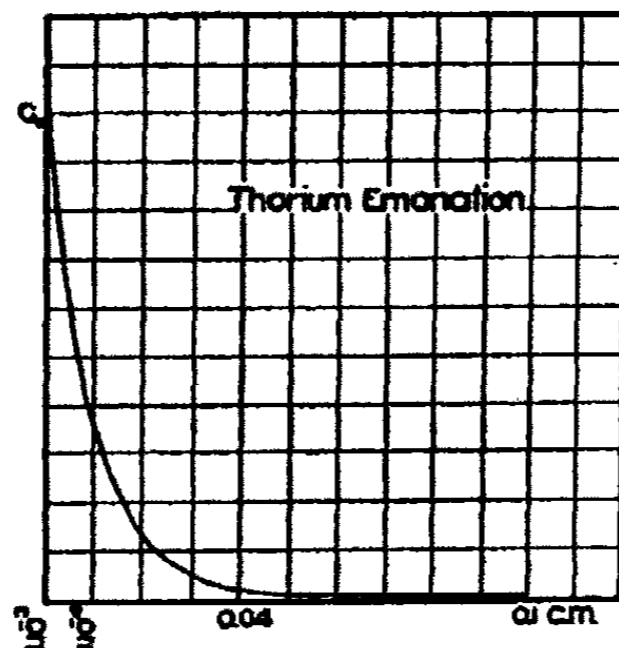

Fig. 3

If we desire to calculate the total quantity of emanation present in the "active" volume, it is not sufficient simply to multiply the concentration of the limiting layer corresponding to the equilibrium partition between the two phases by this volume, for, in spite of the condition of equilibrium, there is a regular diminution of the emanation-concentration in a horizontal direction towards the interior of the liquid and the quantity of emanation so calculated would be too large. Instead of this we must multiply the "active" volume by the average concentration, or, which amounts to the same

thing, multiply the concentration of the limiting layer by the volume in which the quantity of emanation now present would be present in the same concentration as in the limiting layer. The quantity of emanation present in the liquid would accordingly be

$$Co'\alpha v = \frac{Co'r_1}{r_2} \int_{x=0}^{x=r_2} e^{-\sqrt{\frac{\lambda}{D}} x} dx. \quad (2)$$

In spite of the state of equilibrium holding inside the liquid phase the concentration will be subject to a steady decrease. Similarly in the air-column the concentration of actinium emanation will fall off with increasing height on account of the decay of the emanation with time.

Indicating the concentration of emanation at the bottom of the wash bottle by  $c$ , the quantity of emanation in the entire air-column is expressed by

$$rv c' = rv'c = \frac{crv}{\lambda} \int_{y=0}^{y=h} e^{-\frac{\lambda}{a} y} dy. \quad (3)$$

In the liquid phase, where the vertical falling off will occur in like manner, the quantity of emanation is given by

$$vCo\alpha = vCo\alpha \int_{y=0}^{y=h} e^{-\frac{\lambda}{a} y} dy. \quad (4)$$

(cf. also equation (2)).

The partition-coefficient  $\eta$  between the liquid and gaseous phases is derived by the following train of reasoning. From the fundamental law of radioactive change we know that the quantity of emanation breaking up in the liquid phase is proportional to the actual quantity present or, by equation (4), equal to

$$\lambda v'Co\alpha = \lambda v'xc\alpha$$

if

$$Co = xc.$$

The column of air, since a part of the emanation was absorbed

by the liquid, will now only contain a quantity of emanation represented by  $rv'c' - \lambda xc'va$ . From this we see that the mean concentration of emanation in the air phase is

$$c' - \lambda xc' \alpha \frac{v}{rv} \quad (5)$$

and in the liquid phase

$$xc' \alpha. \quad (6)$$

In order to evaluate  $x$  let us take into consideration the fact that the quantity of emanation breaking up per unit of time in the air phase is

$$rv'c' \left( 1 - \lambda x \frac{\alpha v}{rv} \right) (A - I). \quad (7)$$

The sum of losses expressed by equations 7 for the air and by equation 4 for the liquid per second is proportional to the difference of the ionization currents measured when the emanation-laden air is led into the ionization chamber, in one case passing direct and in the other through the particular solution en route. The equations

$$\lambda xc'va + rv'e' \left( 1 - \lambda x \frac{\alpha v}{rv} \right) (A - I) = K[T - i] \quad (6)$$

$$rv'c'(A - I) = K(T - i) \quad (7)$$

where

$$A = \frac{1}{h} \int_0^h e^{-\lambda y} dy - 1$$

$I$  = ionization current when the air does not pass through the absorption vessel.

$i$  = ionization current after passage through an absorbing.

$i'$  = ionization current after passage through a non-absorbing liquid, e. g., mercury.

together with equations (5) and (6) furnish for the absolute partition-coefficient between the two phases the value

$$\eta = \frac{rvA(R - I)}{v\alpha\lambda(I - A)} \cdot \frac{A(R - I)}{I - A} \quad (8)$$

and for the relative solubilities of the emanation in two liquids

$$\eta_2/\eta_1 = \frac{R_2 - I}{R_1 - I} \cdot \frac{I - AR_1}{I - AR_2} \quad (9)$$

$$R = \frac{T - i}{T - i'}$$

Since  $R - I$  (cf. Table 4) is very small, the expression for the partition-coefficient  $n$  given by equation (8) may in our case be simplified as follows

$$\eta = \frac{rvA(R - I)}{\alpha v \lambda (I - A)} \quad (10)$$

where

$$rv = 4\pi r_1^2 Rh = 0.06 \text{ cc}$$

$$r = 8\pi r_2^2 h + 4\pi r_2^2 = 0.034 \text{ cc}$$

$$\alpha = \frac{I}{r_2} \int_{x=0}^{x=r_2} e^{-\sqrt{\frac{I}{D}} x} dx = 0.246$$

$$\frac{rv}{\alpha v} = 8.34.$$

The values of  $I$ ,  $i$  and  $i'$  which represent the mean of 10 determinations and also those of  $R - I$  and  $\eta$  are collected in Table 4 for various velocities of flow. For 3 different velocities the values found for  $\eta$  are 2.2, 1.9 and 2.0, respectively. If we consider the possible sources of error in the determination of  $\eta$ , the chief points will be the fixing of the diffusion coefficient of the actinium emanation in water as  $0.1 \text{ cm}^2 \text{ day}^{-1}$  and the negligence of convection. With regard to the former as the diffusion constant is only met with in our equation among the square roots, a slight divergence from the above values does not greatly influence the result; thus in the case of  $D = 0.09$ , would not be equal to 0.24 but 0.23, and would be 2.17 instead of 2.05.

In choosing the experimental arrangements and in conducting the experiments themselves, special weight was attached to obviating convection, but even if such did occur it could scarcely affect our values. The inclusion of a linear term ( $\lambda c$ ) in the extended Fick differential equation lends quite a different form to the diffusion process; in contrast to the slow diffusion process of unalterable or slowly changing

substances in liquids, the diffusion process of the actinium emanation is very rapid in comparison with the slight convection.

TABLE 4

$q$ in cc per sec.	I	$i$	$i'$	$R-i$	A	
0.1	50	2	3	0.02	0.73	2.2
0.12	85	6	8	0.03	0.58	1.9
0.14	126	13	19	0.05	0.54	2.0

#### Relative Solubility of Actinium Emanation in Various Liquids

The solubility of the actinium emanation in a liquid, referred to that in water taken as unity is given by equation (9), according to which

$$\eta r = \frac{T - ir}{T - i}$$

where  $ir$  is the ionization current after the emanation has flowed through the liquid in question. The values of  $T$ ,  $i$ ,  $ir$  which express the mean results of from 5-10 determinations and those of  $\eta$  in Table 6. Over the interval investigated, the solubility was found to be independent of the velocity of flow.

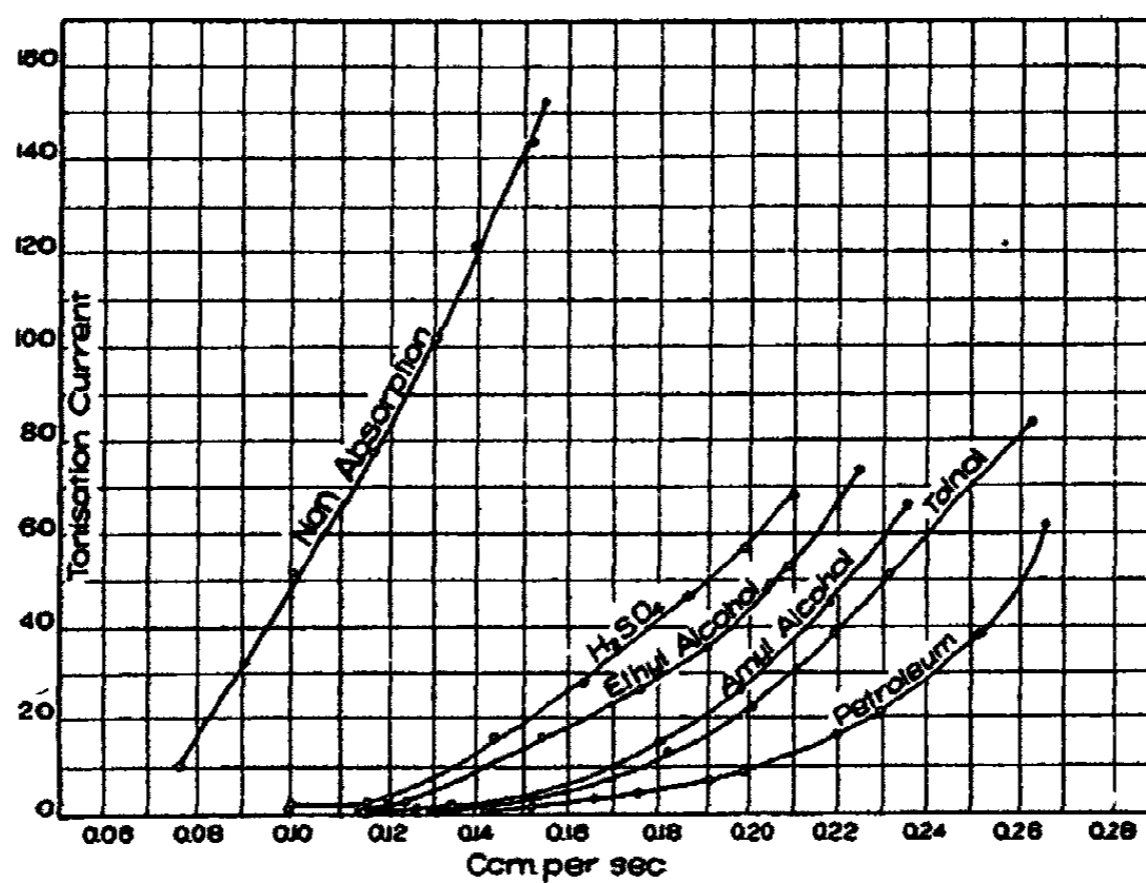

Fig. 4

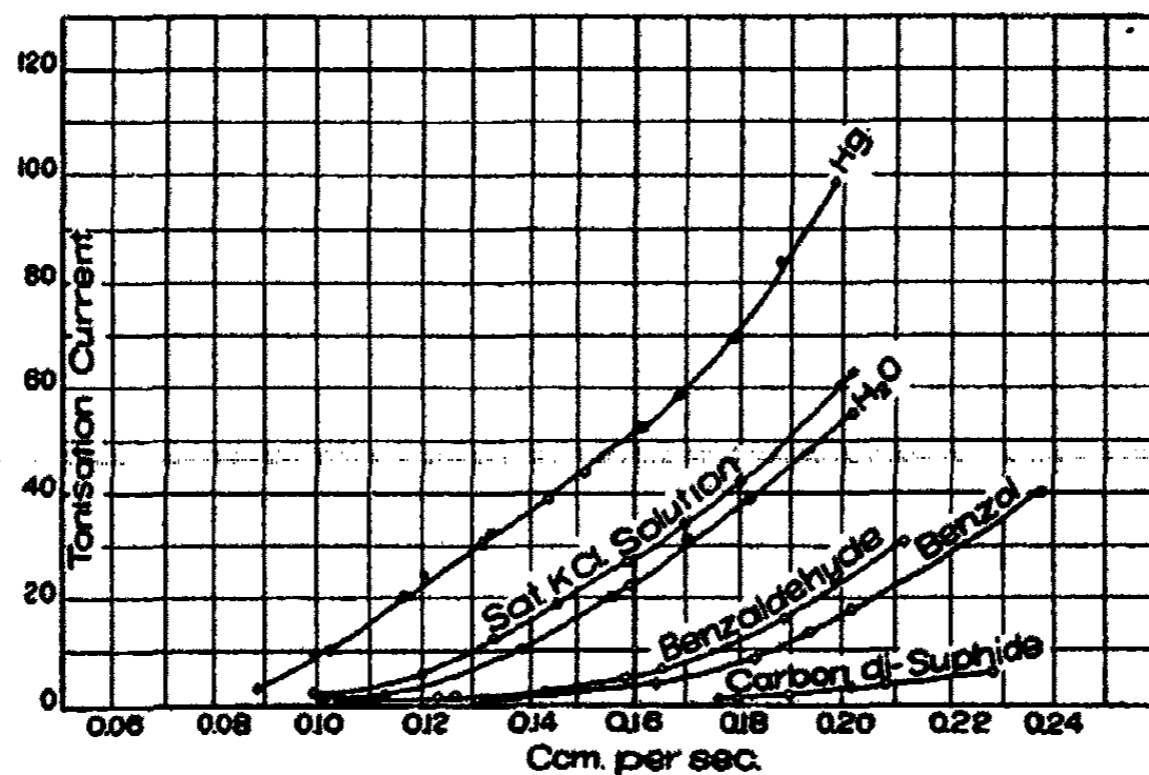

Fig. 5

TABLE 5

q velocity cc per sec.	A'Hg ionization current after passage through Hg	A <sub>1</sub> H <sub>2</sub> O	A <sub>2</sub> KCl sat. solution	A <sub>3</sub> conc. H <sub>2</sub> SO <sub>4</sub>	A <sub>4</sub> ethyl alcohol	A <sub>5</sub> amyl alcohol	A <sub>6</sub> benzaldehyde	A <sub>7</sub> benzene	A <sub>8</sub> toluene	A <sub>9</sub> petroleum	A <sub>10</sub> CS <sub>2</sub>
0.10	9	1.5	2	2	1	—	—	—	—	—	—
0.12	23	2.5	5	3	1.5	—	—	—	—	—	—
0.14	37	12	17	14	11	2	2	—	—	—	—
0.16	50	23	27	26	19	5	5	4	3.5	3	—
0.18	70	38	42	42	29	15	13	13	7	5	0.5
0.20	102	52	60	58	43	28	30	22	16	9	2.5



TABLE 6  
Relative solubility of actinium emanation in liquids

Com. per sec.	KCl solution	Conc. H <sub>2</sub> SO	Ethyl alcohol	Amyl alcohol	Benzaldehyde	Benzene	Toluene	Petroleum	Carbon disulphide
0.10	1.0	1.0	1.1	—	—	—	—	—	—
0.12	0.9	1.0	1.1	—	—	—	—	—	—
0.14	0.7	0.9	1.1	1.5	—	—	—	—	—
0.16	0.9	0.95	1.1	1.7	1.7	1.7	1.7	1.8	—
0.18	0.9	0.9	1.3	1.8	1.8	1.9	2.0	2.0	2.1
0.20	0.8	0.9	1.2	1.5	1.6	1.6	1.7	1.9	2.0

### On the Absolute Actinium Emanation-Concentration of Our Phases

The following consideration leads to the calculation of the concentration of actinium emanation in the air phase. The number of  $\alpha$  particles emitted per second by the actinium preparation employed is equal to  $\frac{2.3 \cdot 10^4 \cdot 2 \cdot 10^4}{100 \cdot 1.6} = 3 \cdot 10^8$ , since, according to Boltwood,<sup>1</sup> the strength of our preparation is nearly equal to 20,000 uranium units and the number of  $\alpha$  particles emitted per second by 1 gram of uranium is, according to Geiger and Rutherford,<sup>2</sup> equal to  $2.3 \cdot 10^4$ , while the ratio of the mean ranges of the  $\alpha$  rays of actinium, and uranium is about 1.6. Seeing that only one-fifth of the  $\alpha$  particles produced by the actinium preparation are caused by decay of the emanation, and that the constant of the emanation  $\lambda$  is  $0.18 \text{ sec.}^{-1}$  we have for the number of emanation atoms per second  $5 \cdot 10^8$ . This is the *maximum* number of emanation atoms which our preparation could give off into the air flowing over it. If the air passes at a speed of 0.2 cc per second, then  $10^{18}$  molecules<sup>3</sup> of air will carry along up to a maximum of  $5 \times 10^6$  emanation atoms.

The maximum emanation-concentration of our air-phase is, accordingly,  $5 \times 10^{-12}$ . We must consider, however, that a great part of the emanation in the interior of the preparation will decay and that in most cases would hardly exceed  $10^{-15}$ .

### On the Absorption of Actinium Emanation by Charcoal

It has already been shown by Rutherford<sup>4</sup> that cocoanut charcoal possesses a high absorptive power for all emanations. Rutherford also determined later<sup>5</sup> the absorption of radium emanation by cocoanut charcoal and Boyle<sup>6</sup> that of thorium emanation by the same absorbent.

<sup>1</sup> Boltwood: Proc. Roy. Soc., 85A, 77 (1911).

<sup>2</sup> Geiger and Rutherford: Phil. Mag., 28, 697 (1910).

<sup>3</sup> According to Rutherford and Geiger (Phys. Zeit., 10, 44 (1908)), 1 cc of air contains  $2.7 \cdot 10^{18}$  molecules.

<sup>4</sup> Rutherford: Nature, Oct., 1906.

<sup>5</sup> Rutherford: Manchester Lit. Phil. Soc. Proc., 53 (1908).

<sup>6</sup> Boyle: Phil. Mag., 17, 389 (1909).

### Experimental

For determining the absorption in charcoal the flow method used for liquids was employed. The experimental arrangement was that already described except that the absorption flask (*e*) was replaced by a small tube 6 cm long (*h*) and 5 mm in diameter. See Fig. 1. The small tube (*h*) contained the coconut charcoal and was closed at both ends by plugs of glass wool. Experiments were carried out at  $180^{\circ}$ ,  $18^{\circ}$ ,  $-6^{\circ}$ ,  $-79^{\circ}$  and  $-184^{\circ}$ , the temperature being determined by means of a pentane thermometer. In these experiments the compressed air, flowing over the actinium preparation and carrying the emanation with it, was replaced by hydrogen in view of the experiments carried out at  $180^{\circ}$ .

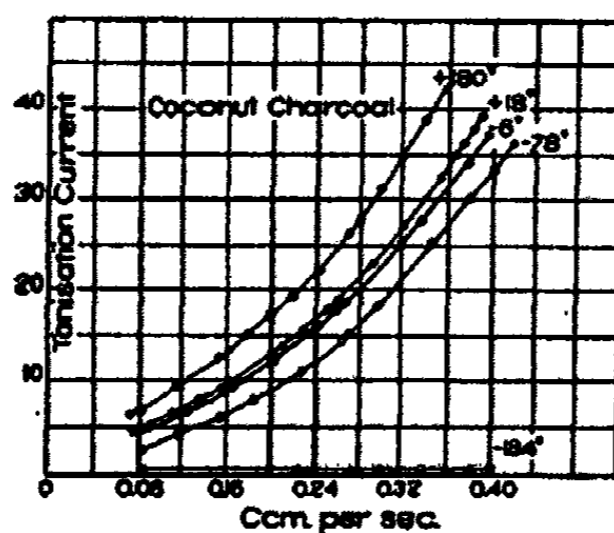

Fig. 6

### Calculation of the Partition Coefficient

The ionization current measured, in relation to the velocity of flow of the hydrogen containing the emanation and the temperature can be seen from Fig. 6 and shows that even at room temperature considerable absorption of the emanation by the charcoal takes place.

Since according to Boyle's experiments,<sup>1</sup> the absorption of thorium emanation by coconut charcoal at  $180^{\circ}$  is very slight, and since the same may be expected for actinium emanation, we may consider the ionization current curve

<sup>1</sup> Boyle: Loc. cit.

obtained for 180° as one obtained in a "non-absorbent" medium, and calculate the partition of the emanation between the solid charcoal phase and the hydrogen phase. Since the absorptive power of the charcoal is much greater than that of the liquids, the loss which the emanation suffers in the gas phase by decay in comparison with the losses suffered in the charcoal phase can be neglected in this case.

In this way we obtain for the desired partition-coefficient the value

$$\mu = \frac{(y-i)v}{\lambda i rv}$$

$\frac{v}{rv}$  = the proportion of the "active" volume.

$I$  the ionization current measured at 180°.

$i$  that measured at some other temperature.

$\lambda$  the radioactive constant.

The value for  $T$ ,  $i$ ,  $1.4 \frac{T-i}{\lambda i}$  and  $\mu_{180}$  can be seen from Table 7; the coefficient 1.4 takes into account the slight absorption still occurring at 180° and is taken from Boyle's investigation.<sup>1</sup>

The ratio of the volumes of the two phases is about one-fourth, but the entire volume of the charcoal is not active as an absorbent, but only the portion into which the emanation is capable of diffusing. The latter can be calculated from the diffusion constant of the emanation and from its period as we have explained at length for the case of diffusion in liquids. In this case, however, since we do not know the diffusion constant of the emanation in charcoal, we must be satisfied with an estimation of the upper limit of the active volume of the charcoal and consequently with one limit of  $\eta$ , by assuming the diffusion constant to be of the same order of magnitude as that for liquids.

From this we have that

$$\frac{v}{rv} = \frac{1}{8} \text{ and } \eta = 20.$$

<sup>1</sup> Boyle: Loc. it.

TABLE 7

Q in cc per sec.	T	i	$\frac{1.4(T-i)}{i\lambda}$	$\mu$
0.08	6.70	5.0	2.6	21
0.12	9.95	7.5	2.6	21
0.16	13.5	10.0	2.3	18
0.24	22.0	17.0	2.2	18
0.28	27.5	21.5	2.3	18
0.32	35.0	27.0	2.2	18
0.36	42.5	34.0	2.6	21

#### Comparison of the Absorption of Actinium Emanation with those of Radium and Thorium Emanations

We can calculate the partition-coefficient of radium emanation between air and charcoal from Rutherford's absorption experiments.<sup>1</sup> He caused about 0.05 cc of emanation to be absorbed by 0.8 gram of cocoanut charcoal at  $-150^{\circ}\text{C}$  and found that by slowly heating the charcoal at  $10^{\circ}\text{C}$  about one-half of the absorbed emanation was given up into the 50 cc receiver. If we take with Homfray<sup>2</sup> the value 1.6 for the density of cocoanut charcoal we have  $\frac{1.50 \cdot 1.6}{1.0 \cdot 8} = 100$  for the partition-coefficient between the charcoal and the gas phase. The partition-coefficient of thorium emanation was determined by Boyle<sup>3</sup> using the flow method and similar considerations to those on p. 434. In this connection he assumed that the entire volume of the charcoal is active. Although, as the figures of Table 3 show, the active volume is relatively larger than in the case of actinium emanation owing to the longer period of thorium emanation, only a fraction of the charcoal volume is active even in this case and the figure 50 therefore would seem to only represent a lower limit of the partition-coefficient of thorium emanation.

<sup>1</sup> Rutherford: Manchester Phil. Soc. Proc., 53, No. 2 (1908).

<sup>2</sup> Homfray: Zeit. phys. Chem., 74, 129 (1910).

<sup>3</sup> Boyle: Loc. cit.

Table 8 contains the partition-coefficients of the three emanations and those of some non-active gases. It is seen from these that the latter are considerably smaller than the former although they relate to 0° C, where the partition-coefficient is larger than at room temperature. This difference is to be explained by the small partial pressures prevailing in the case of the radioactive gases: this partial pressure amounting to about  $10^{-7}$  in Rutherford's experiments, and to less than  $10^{-14}$  in the author's.

Henry's law does not hold for the absorption of gases by charcoal and we must substitute the law of absorption<sup>1</sup> according to which

$$\alpha = X p^{\frac{1}{n}}$$

where  $\frac{1}{n}$  and  $X$  are constants. In the special case where  $\frac{1}{n} = 1$  this expression becomes equivalent to Henry's law. It was found by Titoff<sup>2</sup> that for all the gases studied by him with the exception of hydrogen the value of  $\frac{1}{n}$  was less than unity; this means that as the pressure is decreased the partition-coefficient between charcoal and the gas phase increases in the case of most gases. If we extrapolate the curve of the partition-coefficients found for actinium emanation at very low partial pressures to atmospheric pressure, it is sufficient to take a value of  $\frac{1}{n}$  only slightly less than unity, *viz.*, about 0.9, in order to obtain a partition-coefficient of the same order as those found by Dewar<sup>3</sup> for ordinary gases. The latter are given in the following table:

<sup>1</sup> Freundlich: Kapillarchemie, p. 92.

<sup>2</sup> Titoff: Zeit. phys. Chem., 74, 657 (1910).

<sup>3</sup> Dewar: Loc. cit.

TABLE 8

Gas	Temperature	Partition coefficient between charcoal and gas	Authority
Carbonic dioxide	0°	21	Dewar
Oxygen	0°	18	
Nitrogen	0°	15	
Argon	0°	12	
Hydrogen	0°	4	
Helium	0°	2	
Actinium emanation	18°	> 20	Author
Thorium emanation	18°	> 50	Boyle
Radium emanation	10°	100	Rutherford

#### Summary

A flow method has been elaborated which permits of determining the partition of a gas of short life, between a gas phase and a liquid phase.

By the aid of this method, the solubility of actinium emanation in saturated aqueous potassium chloride solution, water, sulphuric acid, ethyl alcohol, amyl alcohol, acetone, benzaldehyde, benzene, toluene, petroleum, and carbon disulphide has been determined.

The solvent power of the liquids for the actinium emanation increases in the order given above, this order coinciding perfectly with that found for radium and thorium emanations. This points to the close chemical relationship of the three emanations.

The partition-coefficient of the actinium emanation between water and air at ordinary temperatures is 2, and is thus larger than that found for thorium emanation, which is 1, and that for radium emanation, amounting to 0.3.

As with radium and thorium emanations, the partition-coefficient of the actinium emanation between cocoanut, charcoal and air, at ordinary temperatures, has a very high value; its lower limit being determined as 20.

Finally I wish to express my sincere thanks to Professor Rutherford for his valuable suggestions and continued interest during the progress of the above investigation.

## THE DETECTION OF ACTINIUM EMANATION IN SOLUTIONS OF MINERALS

BY G. HEVESY

Dr. Boltwood found<sup>1</sup> in his research on the relative activity of the radioactive bodies in uranium minerals that the presence of actinium emanation in air bubbled through solutions of these minerals could not be detected.

This is not to be expected because the activity of actinium and its products is considerable, amounting to one-quarter of that of the uranium in the mineral, and further the evolution of the emanation by the powdered mineral is not difficult to detect. At Professor Rutherford's suggestion, therefore, the author commenced a series of experiments to see if actinium emanation differed essentially from radium and thorium emanations in its capacity for being evolved from solutions and from solids, for, as is well-known, these emanations are evolved much more easily from solutions than from the solid substance.

After it had been found in working with actinium preparations that an air current could draw the actinium emanation through water and aqueous solutions, and that a quick current did expel more emanations from a solution of a solid, than from the solid itself, when proper precautions were taken, experiments were commenced on solutions of pitchblende.

The disposition best suited for experiment was as follows: The space between the small wash bottle containing the actinium solution, and the electroscope in which the emanation is measured, was made as small as possible. Much larger effects are obtained also if this space be filled with water or some other liquid, which absorbs little, than with air, for when the air current carrying the emanation passes through an air space it diffuses in all directions whereas when it passes through water it distributes itself over a narrow cylinder

<sup>1</sup> Am. Jour. Sci., 25, 270 (1908).



only. In the former case the short-lived emanation has more time to disintegrate than in the latter.

In one experiment the activity of the air current containing emanation after passing through a wash bottle of volume 5 cc was only one-third of that given when it passed through the same bottle filled with 4 cc of water, and this in spite of the fact that the absorption of the emanation by the water is not inconsiderable.

The explanation of this result has been given in the preceding paper.

#### **Experiments to Detect Actinium Emanation in Solutions of Pitchblende**

About 1 gram of finely powdered Joachimsthal pitchblende was dissolved in hot, concentrated nitric acid, the solution filtered from the silica and boiled for several hours to expel the radium emanation completely.

The solution was then concentrated to about 10 cc. 2.5 cc of this was placed in a small wash bottle of volume 3.5 cc connected with an electroscope.

Dried air from a compressed air bottle was bubbled through the solution into the electroscope. An air current of 0.4 cc per sec. gave an activity of 2 div. per minute, and one of 0.6 cc per sec. 3 div. per minute. On repetition of this experiment with 1.5 gram pitchblende instead of 1 gram an activity of 3 div. per minute was obtained with a current of 0.4 cc per sec.

The proof that this activity is really due to the actinium emanation, and not to radium emanation or thorium emanation, is an easy one owing to the great differences in the periods of the three bodies.

The half value period of actinium emanation is 3.9 sec., of thorium emanation 53.5 sec., and of radium emanation  $3.3 \times 10^5$  sec.

If, therefore, the air current be stopped and continuous measurements of the activity in the electroscope be made, there will be practically no activity left after the first minute

if the current has contained only actinium emanation, if it contained thorium emanation a considerable percentage of the initial activity will be left, and if radium emanation the activity will remain unchanged.

The activity of the air current in one experiment was 3.05 div. per minute. The current was then stopped and a total activity of 0.5 div. per minute was found in the first half-minute after shutting off. This corresponded to 16 percent of the activity of the emanation. The theoretical value calculated from the formula

$$y_{\tau} = \frac{1}{30} y_0 \int_0^{30} e^{-\lambda t} dt \quad \text{is 18 percent.}$$

In another experiment the activity was measured in the interval between 30 and 60 secs. after shutting off the air current. It gave a value 14 percent of the emanation's activity.

The theoretical value derived from the formula

$$y_{\tau} = \frac{1}{30} y_0 \int_{30}^{60} e^{-\lambda t} dt \quad \text{is 10 percent.}$$

When it is taken into account that the activities measured are small this agreement of experiment with theory is quite satisfactory. Had the emanation been radium emanation, the activity would not have been influenced in the slightest degree by the stoppage of the air current, further it cannot be thorium emanation for Boltwood<sup>1</sup> states that the pitchblende used contained no thorium.

It must therefore be concluded that this emanation detected by us in the solutions of pitchblende is that of actinium.

*Physical Laboratories,  
The University of Manchester*

<sup>1</sup> Loc. cit.

# ON A THERMODYNAMIC MEASURE OF THE DEGREE OF POLYMERIZATION OF LIQUID SUB- STANCES

BY M. M. GARVER

## Introductory

At the present time physical chemists are dependent almost entirely upon two general sources for their knowledge of the molecular constitution of liquid substances; (a) the remarkable generalizations of van der Waals and the experimental results due to many investigators embodied in the numerous tests of the van der Waals equation, and (b) the monumental experimental work of Sir W. Ramsay and J. Shields<sup>1</sup> in connection with their modification of the equation of Eötvös. These two sources of information, each interpreted in connection with the corresponding experimental data do not always lead to consistent results, although both agree in attributing to special classes of liquids a considerable degree of polymerization. In the interest of pure science it is very desirable that a reliable criterion of the molecular changes accompanying the process of condensation from the vapor to the liquid phase should be established. The theoretical foundation of the method of Ramsay and Shields is not fundamental and when accepted at all, is accepted as open to doubt. In the first place the latter method, based as it is on the surface tension of the liquid, is capable of giving only relative values as compared with certain substances taken as standards because they agree with each other in possessing the same surface-tension-temperature characteristics. But what proof is there that the half-dozen standard liquids are not polymerized?

The van der Waals equation was originally based on the principle of continuity between the vapor and liquid states on the assumption that there is no material molecular change

<sup>1</sup> Zeit. phys. Chem., 12, 433 (1893).

accompanying the transition from vapor to liquid and *vice versa*. Latterly, van der Waals has concluded<sup>1</sup> that all substances in the liquid phase must consist, more or less of polymerized molecules. This latter conclusion is at variance with the Ramsay and Shields' criterion. The subject is then in a somewhat unsettled state so that a reliable criterion containing only assumptions that may be regarded as experimentally established and in accordance with the principles of thermodynamics and the accepted laws of energy, cannot fail to afford interesting results. The present paper is an attempt to establish such a thermodynamic criterion. The degree of success of the attempt must be determined solely by its consistency with, and ability to explain, experimental facts and obvious deductions from those facts. Whether tenable or untenable as a theory, the facts and deductions upon which the theory is based seem to justify at least a careful consideration before a final judgment is passed.

#### The Theoretical Exposition

In a recent paper on the "Range of Molecular Action and the Thickness of Liquid Films,"<sup>2</sup> it was shown that for a number of substances representing different classes of chemical compounds and for a considerable range of temperatures the surface tension of the liquid phase *per unit area of cross-section* is practically equal numerically to the pressure the substance would exert if it were a perfect gas. In the same connection it was shown that both the thickness of the liquid film and the molecular attraction in the film vary with the temperature. Hence the surface-tension is a function, not of the temperature alone, but of the thickness of the film as well, or, mathematically expressed,

$$\frac{\gamma}{\tau} = \rho \frac{R}{m} T \dots\dots\dots (A)$$

where  $\gamma$  is the experimentally observed surface-tension,  $\tau$  the

<sup>1</sup> *Die Zustandsgleichung*. See remark by Prof. Bancroft: Jour. Phys. Chem., 15, 882 (1911).

<sup>2</sup> Jour. Phys. Chem., 16, 234 (1912).

computed thickness of the liquid film,  $\rho$  the density of the liquid,  $m$  the molecular weight of the substance as a vapor,  $R$  the gas constant and  $T$  the absolute temperature. If this equation be analyzed and studied in connection with the established numerical relations of the experimental facts it shows that the value of the ratio  $\rho/m$  is independent of polymerization. For it holds true for widely different sorts of substances and, so far as tested, for considerable differences in temperatures. Since  $m$  is the molecular weight of the substance in the form of vapor and  $\rho/mRT$  gives the surface-tension per unit area of cross-section we have the striking fact that  $\rho \frac{R}{m} T$ , the pressure per unit area the substance would exert as a perfect gas, is numerically equal to the tension per unit area exerted by the liquid film. If the number of molecules per unit mass is different in the two phases, liquid and vapor, and  $\rho \frac{R}{m} T \equiv \frac{\rho}{m} RT$ , then it must be true that any variation in the numerical value of  $m$ , the molecular weight, merely changes the density  $\rho$  in the same proportion. This peculiarity in turn becomes explicable and consistent with the experimental facts if we assume the applicability to both liquids and gases of Maxwell's law of distribution of molecular energies. This is that

$$\frac{1}{2} m_1 u_1^2 = \frac{1}{2} m_2 u_2^2 = \frac{1}{2} m_3 u_3^2 = \dots$$

or, that the translational energy of the molecule is independent of the mass of the molecule and of the phase of the substance, but is proportional to the absolute temperature. An interesting experimental verification of Maxwell's law is given by Philip Blackman,<sup>1</sup> who uses it to determine the relative molecular weights of dissolved substances.

If Maxwell's law holds, and it seems necessary to assume its truth in order to understand the above-mentioned characteristics, then when two or more molecules coalesce to form one there is a change in the total volume with a correspond-

<sup>1</sup> Jour. Phys. Chem., 15, 866 (1911).

ing change in the density but no change (if the temperature be kept constant) in the average energy of translation per molecule, while there is a change in the aggregate molecular kinetic energy,  $\Sigma^1/2mu^2$  because the total number of molecules has changed.

The effect of the change in the number of molecules by polymerization during an isothermal process involving an increase in the density would, with a given volume of a gaseous substance, be to diminish the outwardly directed pressure per unit area to something less than would have been found with the original number of molecules. Or, we should infer that the external pressure necessary to compress a gas or vapor would increase more slowly when there is polymerization than when there is no polymerization, but molecular attractions only. For suppose polymerization in a vapor to take place at a certain definite minimum molecular volume which we will assume is a function of the temperature; then any decrease in the aggregate volume at that temperature must necessarily bring about a decrease in the number of molecules instead of an increase in pressure, for the pressure could not be increased without diminishing the average molecular volume of the vapor which we have supposed to have reached a definite minimum. This is exactly what we observe in the so-called saturated vapors,—there is a definite maximum pressure and minimum volume corresponding to each temperature. Hence at this particular temperature the pressure per unit area will remain constant although the aggregate volume may be steadily diminished because there is a corresponding decrease in the average molecular volume, either by supersaturation (*i. e.*, polymerization) or liquefaction.

This view of the function performed by polymerization as a preliminary to change of phase from the vapor to the liquid furnishes a rational explanation of the experimentally observed rectilinear portion of an isothermal curve and eliminates two of the three values for the volume in the reflexed theoretical portion of a van der Waals isothermal. This

cubic curve arises from the theoretical assumption that the liquefaction takes place in consequence of the action of molecular forces which are proportional to the *square of the density*. But from equation (A) for the surface-tension, if  $\tau$  is the thickness of the superficial layer, it is evident that the attraction in the film is proportional to the density and *not to the square* of the density, so that van der Waals' assumption that the molecular attraction may be represented by  $a/v^2$  cannot be maintained as in accordance with the laws of molecular attraction. If the force action be directly proportional to the density, and a polymerized molecule occupies the same volume as a simple molecule, then both density and surface-tension are linear functions of the polymerization. If molecular volumes are limited to a minimum value then the only remaining way the density can be increased is by the union of molecules. But from Maxwell's law a union of molecules implies that, when the temperature is constant, internal molecular energy must leave the system; and from Clausius' virial, an equal amount of molecular potential energy must escape from the system with the molecular kinetic energy. If, then, it be found that the heat given out during the change of phase from vapor to liquid is in excess of the equivalent of the work done by all the forces, external or internal or both combined, we must conclude, if the process be isothermal, that a portion of the internal molecular energy has left the system as heat because the actual number of molecules has decreased.

It is evident, then, that if we can determine experimentally the total heat given out during an isothermal process and can otherwise estimate how much of that heat is equivalent to the action of any forces concerned, then the excess of the heat over that which can be attributed to work done by forces, external, internal, or both combined, must be due to a decrease and consequent union of the molecules concerned, *i. e.*, to polymerization.

**Theoretical Summary**

If the molecular forces are directly proportional to the density—and the evidence seems incontrovertibly to prove that such is the case—then we have in liquids exactly the same law of force—except as to sign—that holds for a perfect gas. Then in order to determine the proportion of the heat of vaporization that is due to the action of forces and that due to polymerization, it will merely be necessary to compare the experimentally found heat of vaporization with the heat equivalent of the work required to produce the same change in density in the given substance on the assumption that the force varies directly as the density. Hence if the preceding statements can be established as legitimately deducible from undoubted experimental facts, then it follows as a consequence that *during an isothermal change in the density of any fluid substance accompanying a change in the volume, the heat given out or absorbed during such process will exceed the heat given out or absorbed by a perfect gas of the same molecular weight by an amount exactly equivalent to the polymerization or change in the number of molecules.* This statement may be expressed mathematically by the equation

$$H = L - \int_1^2 P dv$$

where  $H$  represents the heat of polymerization,  $L$  the experimentally determined heat of vaporization, and the integral  $\int_1^2 P dv$  represents the work in calories required to produce isothermally the same change in density in a perfect gas of the same molecular weight and temperature. For from Maxwell's law the internal kinetic energy of a fluid is proportional to the absolute temperature and is independent of the volume *provided the number of molecules remains constant.* Hence, also, the amount of heat given out or absorbed in an isothermal change in volume, or change in density, must be independent of whether the force be an external pressure or an internal attraction or both combined so long as there is



no change in the number of molecules,—the only effect of internal attractions being to reduce the amount of external pressure required. Otherwise expressed, the work

$$W = \int_1^2 (p + \gamma) dv = \int_1^2 P dv$$

if  $(p + \gamma) = P$ , where  $P$  is a force equivalent to the externally applied pressure  $p$ , and the internal attraction  $\gamma$ . It has been shown that we may substitute an ideal gas pressure for the actual, combined, pressure and attraction because the pressure exerted by a molecule as a vapor is numerically equal to the attraction of a molecule of the liquid quite independently of whether the vapor molecule constitutes the whole, or only a part, of the liquid molecule. It is then immaterial whether we assume all the forces to be external pressures or internal attractions, *since the heat equivalent of the work due to the forces is independent of whether the force is an externally applied pressure or an internal molecular attraction, irrespective of all polymerization in the molecules that cause the attraction.* This being established, it follows that the ratio

$$r = \frac{L}{\int_1^2 P dv}$$

will be unity for an isothermal change in volume from a vapor to a liquid in which there is no change in the number of the molecules concerned in the process.

Unfortunately the value of  $H$  as thus determined, being a pure energy relation, does not lend itself directly and readily to the determination of the molecular weights of liquids as compared with the molecular weights of the corresponding vapors, but the relative values themselves are interesting and instructive. Also when applying the theory it is necessary to take into consideration the principle disclosed in Clausius' theorem of the virial, that in the case of a liquid one-half the excess heat given out represents potential energy and one-half kinetic. That is, *with the disappearance of the molecular*

*kinetic energy from the substance, molecular forces to the same extent also disappear, for when the molecules coalesce the potential energy due to molecular attractive forces also disappears to the same extent.* Since the whole theory turns on this point and is likely to be misapprehended, some additional discussion is necessary before proceeding to illustrative applications of the theory.

#### **Some Points of Conflict with the Current Theory**

The view of polymerization and of the relation the energy changes bear to polymerization presented above is of course incompatible with that conception of the kinetic theory which regards molecules as spherical masses necessarily separated from each other by a distance equal to the two radii and that they collide and rebound from each other like billiard balls. On the contrary, it seems to me that the experimental facts indicate that the union of two molecules to form one molecule requires us to conclude that the two molecules after union have the same center of mass, so that the two molecules after union occupy only the amount of space, or volume, previously occupied by each constituent separately. The more recently developed corpuscular, or electronic, theory of the atom necessitates this view of a molecular union, and consequently leads to a different interpretation of the  $b$  in the factor  $(v-b)$  of van der Waals' equation. Coalescence, or polymerization, of molecules affords us a perfectly rational explanation of the difference in behavior between gases and vapors and accounts for the fact that less external work is required to produce a given increase in density in a vapor than in a gas, and that a larger quantity of heat is given off by the former than can be accounted for by the work done on the assumption that the number of molecules remains unchanged.

Again, consideration based on the relation of potential to kinetic energy in such a molecular system must lead to a revision of the conception of intrinsic or molecular pressure. When two or more molecules unite to form a single molecule

there is no physical thing remaining that can be made to represent, or be interpreted as, a pressure. The pressure per unit area exerted by, and the attraction per unit area between, polymerized molecules seem to be unaffected by the polymerization even though the polymerization increases the density. So long as forces exist between molecules pressure may be used to represent the force relation; but when two molecules unite to form one single molecule one-half the sum of the two energies *in an isothermal change* must leave the system as the molecular energy of heat. There remain, then, no forces to represent a pressure,—the molecular kinetic energy of the vanished molecule with its complement of potential energy having left the system as heat nothing remains but an increased density to represent the decrease in the number of molecules. In a *fluid* system of discrete flying corpuscles there is nothing corresponding to a static pressure. If the molecules are close enough together to be held partially by the molecular forces the external pressure required is merely diminished; but when two molecules unite, the internal tension or force acting between them disappears simultaneously with the distance as the molecular energy of heat. The hypothetical distance between molecules involving, mathematically, an infinite force when the distance becomes vanishingly small, simply does not exist when molecules unite because they then both possess the same center of mass without leaving anything to be represented by the force function except the change in density and the heat that is dissipated when they unite. A careful consideration of the experimental evidence will show that the use of the  $pv$  function to represent the *energy changes* caused by the changes in the number of molecules due to polymerization is as impossible to interpret in terms of  $pv$  as the union of hydrogen and chlorine in terms of  $pv$  where there is no change in the volume of the constituents, since in the case of polymerization we do not know what aggregate amount of volume change is introduced by the polymerization. In each case the energy takes the form of heat and leaves the system; hence all expressions of such energy

changes in terms of changes in  $p$  and  $v$  must be more or less illusory. However, since energy in whatever way expressed must have the same dimensions in the fundamental units,  $pv$  may be used and may be made to yield consistent numerical results even in cases where the symbols separately have no physical meaning as in the osmotic theory of electromotive force. The frequent references in the current literature to the molecular pressures in liquids and solids involving pressures running up to hundreds of thousands of atmospheres, and even in one case, to millions,<sup>1</sup> cannot represent any real physical quantity because the assumed force function is erroneous.

#### The Present Theory Supported by Recent Osmotic Theory

If there still remains any doubt as to the validity of applying the equation of a perfect gas to the work done by the forces concerned during an isothermal change in volume from a vapor to a liquid, the attention should be directed to what is known as the van't Hoff equation for osmotic pressure and to the equation for the work done by osmotic pressure. Here the work is due to the molecular pressure of a liquid and is given by an equation identical in form with that required to express the work done by a perfect gas. The present writer has given a rigid thermodynamic proof<sup>2</sup> (the only one, so far as his knowledge goes) of that which the labors of Professor Morse and Dr. Frazer<sup>3</sup> had already conclusively established experimentally, that the *volume* in the equation

$$W = pv \log_e \frac{v_2}{v_1}$$

where  $p$  is the osmotic pressure, really refers to the volume of the liquid solvent and *not* to the volume of the solute; and as thus interpreted is not confined to dilute solutions. In a later paper (l. c., p. 651) it was shown that "the volume con-

<sup>1</sup> For a résumé see W. C. Lewis: Trans. Faraday Soc., 7, 94 (1911).

<sup>2</sup> Jour. Phys. Chem., 14, 260 (1910).

<sup>3</sup> Am. Chem. Jour., 36, 39 (1906).

cerned in osmotic pressure is the volume of the solvent increased in the ratio  $\frac{N}{n}$  while the pressure is diminished in the ratio  $\frac{n}{N}$ . This is equivalent to ascribing to the one- $n$ th part of the solvent a volume  $n$  times as large as it actually occupies with a corresponding diminution in pressure."

The present proposal is then merely extending to the *whole liquid* what has been experimentally and theoretically established for years and has given satisfactory and consistent results when applied to the one- $n$ th part of the liquid solvent. This evidence taken in connection with the additional evidence that the attractive forces in a liquid film may be expressed in terms of the pressure which the substance would exert as a perfect gas seems to establish conclusively the validity of the proposed application.

#### Illustrative Applications

In accordance with the theory above presented as to the relation of the heat liberated to the molecular change which takes place when a substance passes from the vapor to the liquid phase, a few examples representing different sorts of chemical compounds will be calculated so as to indicate the method and determine the numerical results. Since, as stated above, the value of  $H$  being a pure energy relation, it remains to express it as a function of the change in the number of molecules. In order to do this satisfactorily, data are necessary which are available in only a comparatively few cases. As a first illustration we shall take the case of water at  $0^{\circ}$  C. Since in all the cases to be considered the mass will be unity, we may substitute the reciprocal of the volume for the density, and *vice versa*, depending upon which value is most readily available. Also in order to avoid the use of double, negative signs, the order of integration limits will be reversed, when necessary.

The volume of 1 gram of saturated vapor of water at  $0^{\circ}$  C is 204,000 cc. The liquid density will be taken as 1. The intrinsic pressure of liquid water at  $0^{\circ}$  C or  $273^{\circ}$  A is 1235

atm., as calculated from  $\frac{R}{m}T$ .  $L$  the heat of vaporization expressed in ergs will be  $606.5 \times 4.2 \times 10^7$  ergs =  $2.543 \times 10^{10}$  ergs. The value of

$$\frac{R}{m}T \int_1^{204,000} \frac{dv}{v} = 1.524 \times 10^{10} \text{ ergs} = W \text{ (say).}$$

Hence  $r = \frac{L}{W} = \frac{2.543}{1.524} = 1.67$ , and  $H = (2543 - 1524) \times 10^7$  ergs. The ratio  $r$  will be found the more convenient value to use as a check.

In order to simplify the discussion  $H$  may be expressed in calories. Hence since  $H = L - W = 1019 \times 10^7$  ergs, 243 may be taken as the number of calories representing the excess heat given out over and above all the work due to forces, external and internal, done upon the substance. From the preceding theory, this excess must be attributed to a decrease in the number of molecules. To determine approximately the molecular change we may apply Maxwell's law, writing  $E_1$  and  $E_2$  for the molecular kinetic energies and  $n_1$  and  $n_2$  for the relative number of molecules. That is, we must have, if  $x = n_1/n_2$

$$\text{and } \frac{E_1}{E_2} = \frac{n_1}{n_2}, \text{ then also } \frac{E_1 - E_2}{E_2} = \frac{n_1 - n_2}{n_2} = x - 1.$$

The value of  $H = 243$  calories may be taken as representing  $2(E_1 - E_2)$ . Hence an assumption as to the relative number of molecules enables us at once to calculate  $E_2$  in calories, and such calculated value must, at least, not be inconsistent with experimental facts. If we assume that the molecule of water has the formula  $4(H_2O)$  as indicated by Ramsay and Shields in their determination, then  $n_2 = \frac{1}{4}n_1$ , so that

$$\frac{n_1 - n_2}{n_2} = \frac{2(E_1 - E_2)}{2E_2} = \frac{243}{2E_2} = 3 \therefore 2E_2 = 81,$$

or the total molecular energy remaining is 81 calories. Now

we know that water in freezing gives out about 80 calories per gram while the specific heat drops to about one-half its former value. Therefore no assumption making the residual molecular energy of the water at  $0^{\circ}\text{C}$  less than 160 calories could be entertained as agreeing with the experimental facts. The total energy may be more but probably not less than 160 calories. If we suppose the specific heat of ice to be the same at low temperatures as at  $0^{\circ}\text{C}$  the total residual molecular energy might reach 216 calories. The value of  $x\left(-\frac{n_1}{n_2}\right)$ , when we write  $2E_2 = 160$ , is 2.5 and for  $2E_2 = 216$ ,  $x = 2.1$ .

In case no other limit as to the residual molecular energy is available an upper limit may be obtained by assuming that the total residual molecular energy of a liquid cannot exceed the product of the specific heat and the absolute temperature. In this case the value of  $x$  may possibly be too small but is probably not too large. If we apply this criterion to water at  $0^{\circ}\text{C}$  we get  $\frac{243}{273} = x - 1 \dots x = 1.9$  (nearly). Of the three values for  $x$  the second seems the most probable and is also almost exactly the mean between the other two.

It should not be overlooked in this connection that the value of  $x$  as above determined shows only the change in the number of molecules. In the case of acetic acid, for instance, we shall find that  $\frac{L}{W} = r$  is only 1.3 at the normal boiling point. From Ramsay and Young's value<sup>1</sup> for the vapor density it may be seen that the molecular weight is already  $1.7 \times 60$ . Hence the molecular weight of the liquid may be considerably over twice the molecular weight of the normal vapor.

We may next consider water at its boiling point. The data required are  $L = 537 \times 4.2 \times 10^7 \text{ ergs} = 2255 \times 10^7$  and

<sup>1</sup> Winkelmann's Handbuch: Wärme, p. 1050.

$$W = \frac{R}{m} T \int_1^2 \frac{dv}{v} = 1.712 \times 10^9 \int_{1.093}^{1650} \frac{dv}{v} = 1.261 \times 10^{10} \therefore \frac{L}{W} = r = 1.79$$

$$H = L - W = 537 - 300 = 237 \text{ calories.}$$

To find  $x$  or the ratio  $n_1/n_2$ , we may take the residual energy  $2E_2$  as 100 cal. greater than at  $0^\circ$ . The most probable value at  $0^\circ$  was 216 cal. Therefore we may assume 316 from which we get from  $\frac{E_1 - E_2}{E_2} = x - 1 = \frac{237}{316} \therefore x = \frac{553}{316} = 1.75$ , a value which should be compared with the mean or most probable value at  $0^\circ$ , 2.1, showing, as should be expected, a considerable decrease.

It is evident that to interpret the value of the excess heat,  $H$  in terms of molecular change, some clue as to the value of the residual energy  $2E_2$  is necessary, or at least some experimental grounds for an assumption. In the case of water the evidence seems to be convincingly strong against the possibility that the molecular weight of liquid water can reach a value as great as  $3 \times 18$ .<sup>1</sup> If the present molecular theory is confirmed by further investigation and experience,<sup>2</sup> then at least we may rely on the value  $r = \frac{L}{W}$  as indicating a degree of polymerization if  $r > 1$ , for if there were no polymerization the ratio should be unity. To emphasize this point, this ratio for as many of the Ramsay and Shields standard liquids as data can be found for, will be computed

<sup>1</sup> Unless a very curious and interesting hypothesis is tenable, if the molecular weight of liquid water at  $0^\circ$  C is taken to be  $H_2O$ , as found by R. and S. it makes the residual *molecular* energy just 80 calories. If we assume that the kinetic energy of solids is entirely *atomic* as compared with the *molecular* energy of fluids, we are led to a confirmation of the result found by Ramsay and Shields. Other indications based on kinetic considerations seem to confirm this low value for the residual molecular kinetic energy of liquid water at  $0^\circ$  C.

<sup>2</sup> Since the foregoing was placed in the printer's hands the supplementary paper by Dr. Ramsay in *Zeit. phys. Chem.*, 15, 106 (1894) has come under the writer's notice. The previous results are considerably lowered and the value of  $x$  for water at  $0^\circ$  C is given as 1.707 and compared with Dr. van der Waals' value of 1.9 for the same quantity. The latter value 1.9 agrees with the minimum value found by the present writer.



and exhibited separately. In addition data can be found for a few acids, alcohols and esters for which the value of

$r = \frac{L}{W}$  will be appended in a table.

The formula

$$\text{Log } W = 0.6570 + \log (273 + t) + \log \log \frac{\rho}{\sigma} - \log m,$$

giving  $W$  directly in calories and requiring only an ordinary 4-place table of logarithms, is convenient for use in the actual computing.

The first five of the following six substances are all included in those assumed to be non-associated and which were used as standards or *norms* in their extensive and valuable work above referred to. No data are available for their sixth substance, chlorbenzene. Carbon bisulphide, which they also find to be normal, or non-associated, is substituted in its place:

Substance <i>m</i> = mol. wt.	$\frac{\rho}{\sigma}$	Temp. <i>t</i>	Calories			$r = \frac{L}{W} (t-0.2)$	
			Heat L	Work W	Diff. L-W		
Ethyl ether <i>m</i> = 73.6	$\frac{0.695}{0.0032}$	35.0	90.0	44.3	45.7	2.03	1.97
Methyl formate <i>m</i> = 59.6	$\frac{0.955}{0.0024}$	31.8	110.0	60.4	49.6	1.82	1.84
Benzene <i>m</i> = 77.4	$\frac{0.813}{0.0027}$	80.0	93.5	51.3	42.2	1.82	1.90
Ethyl acetate <i>m</i> = 87.4	$\frac{0.830}{0.0032}$	77.0	92.7	43.9	48.8	2.11	2.03
Carbon tetrachloride <i>m</i> = 153.7	$\frac{1.594}{0.0008}$	20.0	51.1	28.6	22.5	1.79	1.91
do	$\frac{1.48}{0.0055}$	77.0	44.3	25.1	19.2	1.76	1.91
Carbon bisulphide <i>m</i> = 75.5	$\frac{1.26}{0.00124}$	20.0	88.0	52.9	35.1	1.66	1.82

The present criterion,  $r = \frac{L}{W}$ , indicates that all these substances contain a large proportion of complex mole-

cules. Ramsay and Shields' criterion,  $k$  was assumed to be normal when it had the value 2.12. Their value of  $k$  for the five substances, each diminished by 0.2, is shown in the last column. The two sets of criteria, after deducting the constant difference, do not differ from each other as much as they differ among themselves.

It is hardly possible that this peculiar agreement can be purely fortuitous. It seems much more probable that the observed agreements and differences arise from the accidental variations in the different estimates of the same quantities. For such they are.  $k$  is the ratio of two energies and  $r$  is the ratio of two energies; and both were deduced, although from different viewpoints, with the same value as the ultimate expectation. Both ratios, however, remain to be interpreted. Neither gives the polymerization directly. The surface-tension is a function of the density; and the density in a given substance is, in part, proportional to the polymerization. Hence it seems possible to express the polymerization as a function of the critical temperature; and that is what the Ramsay and Shields formula actually does. The two theories, then, instead of being in opposition, as at first appeared, really afford each other mutual support. To be accurately compared the values of  $r$  and  $k$  should represent the same temperatures. The value of  $k$  is determined from

$$k = \frac{\gamma(\mu v)^{\frac{2}{3}}}{(\tau - d)}$$

where  $\gamma$  is the surface-tension,  $(\mu v)$  the volume of a gram mol,  $\tau$  a temperature difference measured from the critical point, and  $d$  a constant to be determined for each substance. It is not intended at present to discuss the relation of the two theories further than to call attention to the fact that they are *not necessarily* antagonistic.

In conclusion, attention may be directed to the three necessary, experimentally determined values required by the present theory—the *ratio* of the two densities,  $\rho/\sigma$ , the heat of vaporization, and the corresponding temperature. The separate densities need not be known, hence the method of

Sidney Young<sup>1</sup> which gives this ratio directly and accurately without necessarily determining the separate values is particularly applicable. Different observers frequently give quite different values for the heat of vaporization, L. The temperature may easily be observed with sufficient accuracy, since a whole degree variation would be unimportant as compared with the accuracy attainable in the other quantities.

The heat of vaporization L has been found for a large number of substances; also the densities for most liquids and for many vapors. But I can find the necessary complete data mentioned above for comparatively few substances.

The value of  $r = \frac{L}{W}$  for such substances whose data are accessible to me will be computed and appended.

DATA AND ADDITIONAL VALUES OF  $\frac{L}{W}$

Substances	Mol. wt. <i>m</i>	Temp. <i>t</i>	$\frac{\rho}{\sigma}$	Calories		$r = \frac{L}{W}$
				L	W	
Methyl alcohol	31.8	66	$\frac{0.75}{0.00128}$	262	134	1.96
Ethyl alcohol	46	78.4	$\frac{0.74}{0.00171}$	216.4	91.5	2.37
Propyl alcohol	60	97.4	$\frac{0.737}{0.00202}$	166.8	71.8	2.32
Acetic acid	60	118.0	$\frac{0.938}{0.0031}$	97.0	76.3	1.27
Propyl acetate	101.3	140	$\frac{298^2}{1.27}$	83.2	39.4	2.11
Methyl propionate	87.4	79.7	$\frac{314^2}{1.189}$	89	44.3	2.10
Water	18	0	$\frac{204000^2}{1}$	606.5	363	1.67
Water	18	100	$\frac{1650^2}{1.043}$	537	300	1.79

State College, Pa.,  
April 6, 1912

<sup>1</sup> Phil. Trans., 178, 908 (1891). Winkelmann, p. 934.

<sup>2</sup> Ratio of specific volumes.

## A NOTE ON THE MOLECULAR ATTRACTION IN LIQUIDS AND IN LIQUID FILMS

BY M. M. GARVER

In the preceding paper on the "Thermodynamic Measure of the Polymerization in Liquids,"<sup>1</sup> I was led to the conclusion, and so stated, that the tensile strength of liquid films is independent of the mass of the attracting molecules constituting the film. In other words, that although polymerization of the molecules constituting the liquid increased the density of the liquid in the film, yet the tensile strength of the film was not enhanced by the polymerization, but depended only on the number, irrespective of the individual mass, of the molecules. This conclusion seems to be so at variance with all the ordinary conceptions of what constitutes molecular attractions in liquids that a special examination of the grounds for such a conclusion seems necessary.

The basis for the conclusion and statement is found in the following equations which seem to be established beyond reasonable doubt, namely:

$$\frac{\omega}{\sigma} = \frac{R}{m} T = \frac{\gamma}{\tau \rho}$$

where  $\omega$  is the vapor pressure,  $\sigma$  the vapor density,  $R$  the general gas constant,  $m$  the molecular weight,  $T$  the absolute temperature,  $\gamma$  the surface tension,  $\rho$  the liquid density and  $\tau$  the thickness of the liquid film.

If the above equations are true and apply generally to a homogeneous substance at ordinary temperature and to both fluid phases, liquid and vapor, then we must conclude that the attraction in the film is independent of the polymerization. This seems necessarily to imply that a heavy polymerized molecule exerts no more attraction in the film than a lighter and less complex one if we assume that  $\rho$  and  $m$  vary pro-

<sup>1</sup> Jour. Phys. Chem., 16, 454 (1912).

portionally. But  $\rho$  and  $m$  can vary proportionally only if a polymerized molecule occupies the same volume as a simple molecule, unless we suppose that the thickness of the film,  $\tau$ , varies inversely with the density  $\rho$ —a highly improbable supposition, for the film is found to grow thinner at higher temperatures. If we have to admit that

$$\frac{\gamma}{\tau} = \rho \frac{R}{m} T$$

applies whether the liquid is polymerized or not then  $\rho/m$  is not affected by a variation in the molecular weight, or  $\rho$  and  $m$  do vary proportionally. If this be admitted then it seems necessary to conclude that a polymerized molecule exerts only the same attraction that a simple one does. To admit this, however, is to admit an apparent contradiction, that the attraction, assumed to be gravitational, is not proportional to the attracting mass! How is it possible to reconcile the apparent contradiction?

In the first place let us consider the application of Avogadro's rule to vapors and gases. Here, it is evident, the temperature being the same, that a heavy substance exerts exactly the same pressure *per molecule* that is exerted *per molecule* by a substance of lower molecular weight. This is really the basis of the law for, when analyzed, that is the same thing as saying that at equal temperature and pressures equal volumes of all gases contain the same number of molecules, that is, at the same temperature, the pressure exerted by a molecule is independent of its weight.

If then the tension per unit area in a liquid film is numerically equal to the pressure the substance would exert if it were a perfect gas, we must conclude that the *tension per molecule in a liquid film is independent of the molecular weight of the molecule*. I can see no escape from this conclusion. It remains to show that it is not inconsistent with molecular mechanics.

If we apply to molecules the laws of Newton we must conclude that molecules proceed in straight lines unless they

are acted on by some deflecting force. If then at any instant, a molecule describes a curved path of radius of curvature  $r$  we may represent the deflecting force by  $f$ . Since the molecule of mass  $m$  and velocity  $u$  moves in a curve of radius of curvature  $r$  the deflecting force  $f$  may be regarded as a centripetal force acting towards a centre and its instantaneous value may be represented by  $\frac{mu^2}{r} = f$ . If we represent different molecules by different numerical subscripts we shall have for the instantaneous values

$$\frac{m_1 u_1^2}{r_1} = f_1 r_1 = \frac{m_2 u_2^2}{r_2} = f_2 r_2 = \frac{m_3 u_3^2}{r_3} = f_3 r_3 \text{ etc.}$$

As these are assumed instantaneous values we may also assume that similar expressions are true for every instant and that they may therefore be summed so as to yield an average, or

$$\Sigma\left(\frac{mu^2}{r}\right) = \Sigma(f).$$

Since by Maxwell's law the average energy of translation per molecule is independent of the mass but is a function of the absolute temperature, the numerators of the preceding fractions are equal on the average, hence on the average

$$\Sigma(mu^2) = \Sigma(rf).$$

But the  $\Sigma(mu^2)$  is the total molecular energy, kinetic and potential of the molecules of the substance and  $\Sigma(rf)$  may be regarded as a quantity which is proportional to the product of a force and a displacement produced by the force—a quantity also of the dimensions of energy.

If now as previously shown we are required to regard the force as independent of the mass of the individual molecule and the volume of a molecule as independent of polymerization, the average value  $\frac{mu^2}{r} = f$  is in perfect accord with Maxwell's law of average energy of translation, or

$$\Sigma(mu^2) = \Sigma(rf) \text{ and } \Sigma\left(\frac{mu^2}{r}\right) = \Sigma(f).$$

These equations satisfy all the theoretical requirements, for the assumption of equal average forces merely leads to equal average  $r$ 's or volumes.

While the above analysis may not, by some, be regarded as a rigid proof of the law of action, it is at least sufficient to show that the assumption of a force function whose value is not directly proportional to the mass is not necessarily in opposition to a rational explanation of the observed facts and relations. From the above outline it is evident that to separate two adjacent portions of a liquid film an average force proportional to  $\Sigma(f)$  would have to be exerted and that the force required would be proportional to the number of molecules per unit area in the cross-section of the film. It<sup>1</sup> is also consistent with the view that the tensile strength of a film per unit area is numerically equal to what I have frequently referred to as the intrinsic pressure of a liquid, since there is no reason to suppose that the interior of a liquid mass differs from the surface portion further than that the "deflecting force" in the surface always acts towards the liquid mass. The present view lends no support to the view that the surface attraction is so great as to materially increase the density of the surface film, or that "surface energy" is in any essential way different from the rest of the energy of the liquid. Failure to distinguish between "the ability to do work" and energy leads to endless confusion. The discontinuity in the distribution at the liquid surface merely requires a special configuration to produce equilibrium under the special set of conditions imposed by the circumstances of the case.

*State College, Pa.,  
April 24, 1912*

---

<sup>1</sup> The function,  $\Sigma(mu^2) = \Sigma(rf)$ .

## THE THEORY OF EMULSIFICATION. III

BY WILDER D. BANCROFT

Pickering<sup>1</sup> has published an experimental study on emulsions which seems to me so important that I quote it in full:

"In the Sixth Report of the Woburn Experimental Fruit Farm (Eyre and Spottiswoode, 1906) were published the results of an examination of emulsions of paraffin oil in solutions of soft soap, such as are used for insecticidal purposes; this examination has now been extended with the double object of obtaining an emulsifying agent which would, for practical purposes, not be open to the objections presented by those containing soap, and also of elucidating the nature of emulsification. The subject had already been investigated by Ramsden,<sup>2</sup> but his work, unfortunately, did not come under the notice of the writer until that here described had been completed. It is satisfactory to find, however, that Ramsden, pursuing a different line of enquiry, should have arrived at an explanation of emulsification which is essentially the same as that given here.

### Emulsions with Soluble Emulsifiers

"When any liquid insoluble in water is mixed with the latter and broken up into minute globules, as when it is forced through a syringe, the globules remain more or less permanently emulsified whenever the water contains soap or some other emulsifying agent in solution. The whole of the liquid, however, is not an emulsion, properly so called, but a mixture of the emulsion with excess of soap solution; on standing, the true emulsion separates, and, if the substance emulsified is lighter than water, rises to the surface. This is precisely analogous to the separation of cream from milk.

"The time required for an emulsion to rise, and for the

<sup>1</sup> Jour. Chem. Soc., 91, 2001 (1907).

<sup>2</sup> Proc. Roy. Soc., 72, 156 (1903).



volume occupied by it to become constant, depends, naturally, on various circumstances, and varies between several days and many weeks. The line of demarcation between the emulsion and the excess of liquid is generally well marked, for the liquid becomes almost clear, and, if it contains much soap, quite clear, while the emulsion is opaque. In many cases, the emulsion itself separates into two layers, evidently of different composition, the line of demarcation between these being fairly distinct.

"A rise of temperature facilitates emulsification with soap solutions, but there appears to be no difference between emulsions of the same composition when made at different temperatures. For each temperature, and for each proportion of paraffin oil, the quantity of emulsifier which must be present ranges between certain definite limits; thus, to emulsify 75 volumes of oil with 25 volumes of water, the latter must contain from about 0.7-1.8 percent of potash soap; but for 40 volumes of oil to 60 of water, emulsification is possible with from 0.3 to over 25 percent of soap. The explanation of the existence of such limits (especially of the superior limit) will be discussed below, but it may be remarked that the above figures apply to only one particular soap, and that soaps, even when of the same brand, vary greatly in their emulsifying power, it being difficult to obtain emulsification at all in some cases, even with the aid of heat.

"Emulsification appears to occur suddenly: when soap is used, and the solution is not very strong, it is possible to judge immediately by the working of the syringe whether it has occurred or not; but when it has not occurred, no continuance of the pumping, without altering other conditions, will produce emulsification. The increase of viscosity on emulsification is easily explained by the great increase in the extent of the oil-water surface on the oil being reduced to minute globules. An ordinary emulsion, although containing 70-80 percent of mobile paraffin oil, is as viscid as thick cream, and its viscosity increases with the proportion of oil present, even when that oil is a very light one, such as a

benzine. With very high percentages of oil, the emulsion becomes practically solid, resembling a blancmange. Emulsions containing as much as 99 percent of ordinary lighting oil have been made, the remaining 1 percent being a 1 percent solution of soap. Such strong emulsions, however, cannot be obtained directly; they must be made by taking a weaker emulsion, and gradually increasing the paraffin in it, churning it after each addition. Even these strongest emulsions are true emulsions of the oil; that is, it is the oil which is in globules, and the water, although so small in amount, which is the menstruum. There are no signs of the existence of an emulsion of water in oil. As a consequence of this, an emulsion (even a 99 percent one) will mix perfectly with water to form a weaker emulsion, but it will not mix with more paraffin,<sup>1</sup> unless, of course, that paraffin is emulsified with it by further churning. Indeed, the addition of any paraffin in bulk to an emulsion eventually causes the de-emulsification of the whole, the globules of the emulsion being attracted by, and coalescing with, the mass of unemulsified paraffin. It is for this reason that an imperfectly made emulsion will eventually de-emulsify on standing, and so will a very strong emulsion, for it is generally an imperfect emulsion also, as it is so viscid that the whole of the paraffin in it cannot be churned up with it properly. Spontaneous de-emulsification is usually a question of weeks or months, sometimes of years; possibly a very perfect emulsion would never de-emulsify spontaneously at all, but once de-emulsification has started, it progresses at an increasing rate.

“Strong emulsions, especially the semi-solid ones, are very bad conductors of heat. When one of them is heated in a wide test tube, it partially melts, de-emulsifies, and boils; but, although the boiling point may be 160°–170°, ebullition can be continued for five or ten minutes, while a nucleus of the emulsion remains at a temperature far below 100° in the center of the boiling paraffin. The water becomes

---

<sup>1</sup> [Kerosene.]

gradually concentrated in this nucleus, and finally volatilizes explosively.

"Although one of these semi-solid emulsions, when kept in a closed vessel, will only gradually de-emulsify in the course of months, yet, when exposed to dry air, it will do so in a very short time; the edges of the lumps assume the appearance of a transparent, slightly blue jelly, and the whole liquefies in the course of some hours. No such change occurs in moist air. It is evident, therefore, that the change to the transparent condition must be due to the loss of moisture, but it is difficult to see in what the change consists. The opaque emulsion appears to contain a few globules of about 0.0003 mm in diameter, but the bulk of it seems to be devoid of structure, and, if composed of globules, as presumably it is, these must be less than 0.0001 mm in diameter. The transparent jelly presents nothing at all visible under the microscope. Thus the difference between them seems to consist in the presence or absence of a few larger globules, but why these should disappear throughout the mass on exposure to air is not at all clear. The transparent jelly is as stable as the opaque emulsion, when kept in a closed vessel. On placing a portion of it in water it instantly becomes opaque, and gradually disseminates in the water, forming a weak, milky emulsion.

"In a collection of closed-packed spheres of uniform size, whatever that size may be, the volume of the spheres is 74.048 percent of the total volume of the mass; with an emulsion of uniform spheres, the volume of the oil would be less than this, as the spheres are not in actual contact, the separating film of medium being of appreciable thickness. But in emulsions, the spheres are not uniform, and there does not therefore appear to be any reason why the ratio of the volume of the oil to the total volume of emulsion should be of any particular magnitude. The ratios actually found, however, do not differ very widely from that for close-packed uniform spheres, being generally from 65-82 for every 100 volumes of emulsion. This is independent of the proportions

in which the oil and solution are taken to start with, so long as the former does not exceed 80 percent.

“In a number of experiments which were quoted in the Woburn report, the proportions for the oil to water composing emulsions were found to be in the simple ratios of 2 : 1, 3 : 1, or 4 : 1. It was not possible to suggest any explanation of this, and the results (although similar ones have been obtained subsequently) were probably fortuitous. This seems to be established by the fact that these emulsions vary more or less in composition throughout the mass. The nature of this variation will be seen best by an inspection of Fig. 1. Three emulsions were made by churning a 1 percent soap solution with ‘Solar Distillate,’ a paraffin oil distilling almost entirely between 240° and 350°, sufficient to make mixtures containing, respectively, 67, 50 and 33 percent by volume of the oil. These were left undisturbed for twelve weeks, after which the emulsions, which had risen to the top, contained, on the average, 81.0, 81.9 and 77.7 percent of oil, in the three cases, respectively. The emulsions were analyzed from top to bottom, removing for the purpose successive layers, and analyzing each by adding to it a trace of acid, which de-emulsified it. The percentage (by volume) of oil diminishes throughout from the top of the column down-

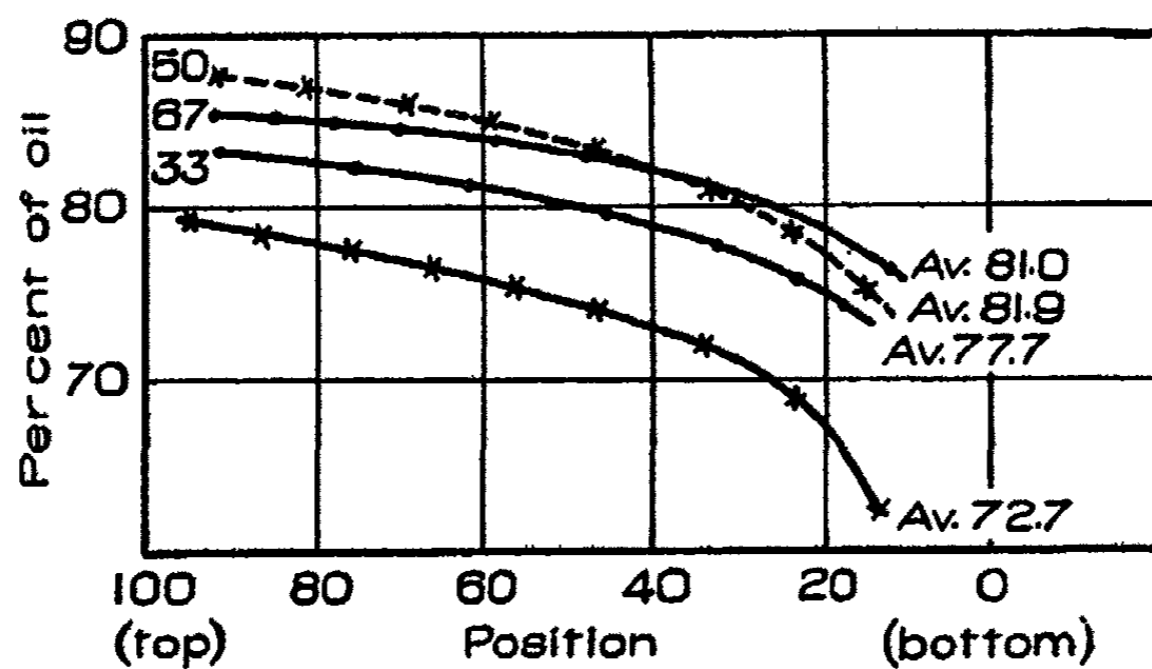

Composition of emulsions. Solar distillate in soap solutions.

Fig. 1

wards, but very slowly at first, and more rapidly towards the bottom. The examination cannot well be extended to the very bottom of the column, as it is difficult to remove the emulsion without drawing with it some of the watery liquid from below. The three emulsions, as will be seen, do not differ much in composition, in spite of the different proportions of the oil and solution taken in their manufacture, and such differences as exist do not vary regularly with these proportions. In none of these cases were there visible any different zones, such as are often noticed, but the analysis gives some evidence of the existence of one in the case of the curve marked 67, for the first three portions removed, embracing a quarter of the whole emulsion, gave the same values, namely, 84.7, 84.5 and 84.6 percent. A more conspicuous instance of the arrangement in zones of equal strength will be mentioned below.

“The emulsification of 50 percent of paraffin was repeated with a 5 percent, and with a 0.2 percent solution of soap as well. The results with the former, when plotted, were almost coincident with those with the 1 percent solution shown in the figure (marked 50); those with the 0.2 percent solution gave lower values throughout, and are represented by the lowest curve in the diagram.

“Differences, such as those exhibited between the emulsions portrayed in Fig. 1, are, no doubt, merely due to differences in the size of the globules, and must be largely accidental. An examination under the microscope was sufficient to indicate that the average size of the globules in the emulsion giving the lowest curve was somewhat greater than that in the others, although no differentiation of these others among themselves was possible.

“All emulsions contain globules of different sizes, and it is possible to form only a very rough estimate as to what is the average, or, rather, most frequent, size of the globules present. With most paraffin oils emulsified in soap solutions containing from 5–0.5 percent of soap, the most frequent size seems to be about 0.0075 mm in diameter, but there are present some

globules of three or four times this size, as well as smaller ones down to one-tenth of it, or less. In the semi-solid emulsions, as already stated, the globules are much smaller. Imperfect churning of the mixture results in larger globules, but a dozen vigorous strokes of a syringe fitted with a rose jet seems to be sufficient to break up the oil as far as it is possible. A deficiency in the proportion of soap to the paraffin results in larger globules, and, if reduced too far, no permanent emulsification can be obtained.

"The character of the oil, also, has an effect on the size of the globules; emulsions with the lighter paraffins, such as the various benzines and motor spirits (sp. gr. 0.8) or 'Solar Distillates' (sp. gr. 0.86); but with mineral naphtha and benzene, the reverse is the case, emulsions with these being exceptionally fine-grained. With crude petroleum, sp. gr. 0.955 (which contains much vaseline), a very thick, unmanageable emulsion is obtained. Turpentine and olive oil do not emulsify with soap solution in the same way as do the paraffin oils, a large portion of the material remains unemulsified, and the line of demarcation between the layers of different composition is not clearly marked. With turpentine, that portion of the mixture which most resembles an emulsion contains only 5-6 percent of the oil, but with olive oil there is a small layer, intermediate between the free oil on the top and the solution at the bottom, which appears to be a true emulsion, as it contains about 70 percent of oil.

"Compared with the oil globules in cream, paraffin emulsions are more coarse-grained, and much less uniform. In cream, the globules are 0.003-0.005 mm in diameter. They are, however, collected together in groups, and are not distributed uniformly throughout the medium as in the case of paraffin emulsions.

"So long as thorough emulsification has been produced, there does not appear to be marked variations in the size of the globules of an emulsion throughout the mass; the only difference observable between the upper and lower layers is

that in the former the globules are more closely packed than in the latter.

“Other soluble substances, besides soap, will act as emulsifiers for paraffin, and some of them are used practically in America. Sour milk and scorched flour are among the latter, and the author has also examined the results obtained with solutions of glue, starch, egg-albumen, saponin and extract of quillaia bark. All these substances give emulsions more or less closely resembling those with soap, but they all appear to be inferior to the latter as regards the fineness of texture of the product, and, consequently, the emulsions separate from the excess of liquid more rapidly. With saponin and quillaia, this is notably so, and with proportions of these materials which have been recommended for use (0.025 percent of quillaia), emulsification is so unsatisfactory that de-emulsification sets in after twenty-four hours, while, if the proportion of paraffin taken for the mixture is large (67 percent), only partial emulsification is obtainable. With some of the other substances mentioned above, for example, milk, it is not possible to obtain a strong emulsion unless the paraffin is added gradually, churning after each addition.

#### De-emulsification

“The de-emulsification of an emulsification may be brought about, (1) by the presence of unemulsified paraffin, as already mentioned; (2) by adding a liquid, such as alcohol, in which the paraffin and water are both soluble; or (3) by destroying the emulsifier. The most convenient de-emulsifier to use when determining the percentage of oil in an emulsion made with soap is a small quantity of mineral acid. With a very strong semi-solid emulsion, a mere trace of hydrochloric acid is sufficient to convert it almost instantly into a mass of liquid oil, with a few drops of water below it. Any sodium salt produces de-emulsification, owing to the conversion of the potassium soap into the comparatively insoluble sodium soap. De-emulsifying action does not appear to be in any way dependent on the de-emulsifying agent

being an electrolyte, for potassium salts are without effect on emulsions in potassium soap, and even hydrochloric acid will not produce de-emulsification (as will be shown immediately) in cases when the emulsifying agent is not destroyed by it.

"In the Woburn report, it was shown that a paraffin emulsion containing 2 percent of caustic soda possessed valuable insecticidal and detergent properties, but the practical de-emulsification produced by soda detracted from the merits of the mixture, making constant agitation of it necessary during use, and rendering a uniform distribution difficult. The amount of paraffin recommended for this wash was six volumes percent, and the soap was reduced to 0.5 percent, so as to minimize the bulk of solid thrown out when the soda was added. From such a mixture, the soda soap generally separates as a flocculent mass, which rises to the surface, mixed with the paraffin, and forms with it a bulky scum which occupies about one-third of the total volume. This scum, as will be shown below, is what may be termed a quasi-emulsion. It varies considerable in its nature according to the character of the soap used, and with one example of soap in our possession (although of the same brand as other samples) it is scarcely distinguishable from a true emulsion. (Caustic potash, it may be mentioned, cannot well be used as a substitute for caustic soda, on account of its price, and, if much soap is present, the soap is gelatinized, forming a magma which cannot be used for spraying.)

"To avoid the disadvantage attaching to the separation of soap in these caustic emulsions, some more suitable emulsifier was sought. When quillaia or glue was used, the addition of caustic soda produced de-emulsification, and the same occurred to a slight extent with egg-albumen or starch; milk, also, is not very satisfactory, as it clots, even when caustic soda is not present. Attention therefore was turned to the possibility of obtaining an insoluble substance to act as an emulsifier. This did not seem impracticable, from the fact that lime had recently been stated to produce emulsification.



**Emulsions with Insoluble Emulsifiers**

"Lime united with petroleum was first used for spraying purposes under the name of 'limoid.' A certain magnesian lime of a very fine-grained character was found to absorb double its weight of petroleum, and the mixture thus obtained, disseminated in three to nine times its volume water, was used as a spray fluid. Subsequently it was found that any ordinary lime would make an emulsion with petroleum, and the proportions recommended in America are 2.2 grams of quicklime to 11 cc of kerosene and 88 cc of water. There does not appear, however, to be any reason for adhering to these particular proportions, for they may be varied largely without materially affecting the results.

"Much work was done on these lime emulsions before a clue was obtained as to their real nature, but only a brief reference to this work will be necessary here. Limes from various sources were examined, and all gave substantially the same results as a calcium oxide prepared from marble, to which the following remarks apply.

"On churning up lime with paraffin and water, a sort of emulsion is obtained, which either rises or sinks in the excess of liquid, according to the proportions used. The separation of the emulsion from the excess of water is much more rapid than in the case of emulsions in soap solutions. By suitably adjusting the proportions, an emulsion of a specific gravity of unity can be obtained; there is then no sinking or rising, so long as the proportion of water present is not more than 50-70 percent, but, on dilution, part of the emulsion rises and part sinks; both these parts contain some oil, but the upper part most.

"The volume occupied by emulsions with lime, and the percentage of oil contained in them, present no features analogous to emulsions in soap solutions, for here the lime itself occupies much of the total volume, and by its weight it drags down the oil and prevents any close-packing of the oil globules.

"The general behavior of these lime emulsions suggests

that they are merely gross mechanical mixtures of lime and paraffin, and not true emulsions. An examination under the microscope confirms this view; the oil globules present in them are very large, and show great variations in size, being, under the most favorable conditions, ten times the diameter of the globules in a soap emulsion: they appear to be merely caught by, and entangled in, the particles of lime. Moreover, their size, instead of being practically constant, independent of the proportions of emulsifier and of oil, as in the case of soap emulsions, seems to be entirely dependent on them, and, if the lime is not present in considerable quantity, the globules are so large that they become visible to the naked eye, the liquid then being an evidently non-homogeneous mixture, which can claim no title to be called an emulsion. With a further reduction in the amount of lime, or an increase in that of oil, a separate layer of the latter appears.

"In one series with 'Water White' oil in proportions ranging from 1.5-67 percent by volume, and with lime equal to 2.2 grams CaO per 100 cc of the mixture, the product became visibly non-homogeneous when about 35 percent of paraffin was reached. A rather lower limit (about 30 percent) was obtained in a similar series with 'Solar Distillate.' In another series with the latter oil, where the paraffin was kept constant at 50 percent, and the amount of lime varies, an apparently homogeneous emulsion was not obtained until the lime reached 10 grams per 100 cc of the mixture. With a very light oil, such as motor spirit, no homogeneous emulsion could be obtained at all, even when the percentage of lime exceeded that of the oil.

"Other finely-divided substances have been examined, and found to give results similar to those with lime, although minor peculiarities are noticeable in the case of each substance; plaster of Paris, precipitated chalk, precipitated silica and alumina were among those which more closely resembled lime in their behavior.

"Mechanical mixtures of such substances with paraffin may conveniently be termed quasi-emulsions, for, with certain

proportions between the solid and the paraffin, they approximate to emulsions in character, and may serve the same practical purposes as true emulsions do. Yet, as will be shown immediately, they are essentially different in constitution from true emulsions.

"A quasi-emulsion with lime may be mixed with caustic soda without any change being produced, beyond rendering it somewhat more viscid, and it can be mixed with other insecticides and fungicides, notably with copper sulphate, thus giving it an advantage over emulsions with soap. On the other hand, it presents decided disadvantages, in the coarseness of the emulsion produced, the large proportion of lime required, and the difficulty of spraying it without clogging or destroying the nozzles of the machines.

"When copper sulphate was added to the lime before emulsification, it was noticed that the emulsion produced was altogether different from that with lime alone, and, following up this indication, it was ascertained that the basic sulphate of copper, precipitated by the action of lime on the copper sulphate, is, by itself, capable of emulsifying paraffin and water, almost as finely as, and much more easily than, soap. If excess of lime is to be avoided, and all the copper is to be precipitated, the basic sulphate should be obtained by adding about 134 cc of lime-water to every gram of  $\text{CuSO}_4 \cdot 5\text{H}_2\text{O}$ ; if otherwise, solid lime may be added to the copper sulphate solution, and, although the quantity of pure lime required is only one-seventh of the weight of  $\text{CuSO}_4 \cdot 5\text{H}_2\text{O}$ , it is advisable in practice to increase this to one-third if commercial lime is used, and to make this into a milk, running it through sacking into the copper sulphate, so as to eliminate any gross particles. On adding paraffin oil to this, and churning, one stroke of the syringe is sufficient to produce a perfect emulsion, and even shaking the mixture will form an emulsion good enough for practicable purposes.

"Such an emulsion possesses nearly all the characteristics of one made with soap, except that, there being a heavy and bulky solid present, the volume occupied by the emulsion

proper does not depend solely on the oil globules, and the emulsion may rise or sink in the excess of solution according to the proportions of oil and basic sulphate used. It generally forms a very smooth cream, with a perfectly clear-cut line of division between it and the excess of liquid. In texture, it appears under the microscope to be identical with emulsions in soap, although the average size of the component globules is about twice as great. Nothing but a mass of oil globules can be seen, as the particles of basic sulphate are generally too small to be visible. If enough of the basic sulphate is present, the proportion of paraffin can be increased up to a very high point, the emulsions becoming thicker, until they are almost solid. With an insufficient proportion of basic sulphate, emulsification is imperfect; the minimum with strong emulsions of 'Solar Distillate' is, approximately, 1 gram of  $\text{CuSO}_4 \cdot 5\text{H}_2\text{O}$ , converted into basic sulphate, for every 120 cc of oil; if the emulsion is weak, the proportion of basic sulphate required is less. In the case of the sulphate of iron, which, as will be mentioned immediately, may be used in the same way, the proportions are of the same order of magnitude, 1 gram of  $\text{FeSO}_4 \cdot 7\text{H}_2\text{O}$  being required to emulsify about 200 cc of oil to make a 6 percent emulsion, 100 cc to make a 20 percent emulsion, and 30 cc to make a 60 percent emulsion.

"To obtain satisfactory emulsions with the basic sulphates, it seems necessary to use a paraffin oil of high boiling point, such as a 'Solar Distillate;' with ordinary lighting oil, emulsification is not perfect, unless the proportion of basic sulphate is very large, and with motor spirit the paraffin is never more than partially emulsified.

"For practical purposes, an emulsion with basic copper sulphate presents many advantages over one made with soap. In the first place, it is a fungicide as well as an insecticide, for it contains all the elements of Bordeaux mixture; secondly, it is very bulky, and the tendency to separate from the liquid is much less. If the copper sulphate taken is 1.6 grams to 100 cc (the quantity used in 'normal' Bordeaux mixture made

with milk of lime), 3.5 cc of 'Solar Distillate' (sp. gr. 0.858) makes with it an emulsion which neither sinks or rises, and if the 'Solar Distillate' is increased to 6 cc, as it might be for winter use, or reduced to 1-2 cc for summer use, the tendency to rise or sink, respectively, would be but small, the slightest agitation being sufficient to keep such emulsions disseminated throughout the liquid. With Bordeaux mixture made with lime-water, as recommended in the preceding communication,<sup>1</sup> only 0.7 gram of copper sulphate to every 100 cc is used, and 1.4 cc of 'Solar Distillate' will make this into an emulsion which will neither sink or rise, and which is of a most convenient strength for general summer use.

"Besides the facility and certainty with which these emulsions can be made, they possess the advantage of being much more permanent than emulsions made with soap. No single instance has yet occurred in which any one of them has de-emulsified spontaneously. Also, they can be mixed with caustic soda (2 percent being generally used) to make a detergent winter wash, without becoming de-emulsified, as in the case of soap emulsions.

"In connection with the use of soda with these emulsions, one or two points must be mentioned. Copper hydroxide will not emulsify paraffin as the basic sulphate does, and, although caustic soda precipitates the basic sulphate  $4\text{CuO}\cdot\text{SO}_3$ , when added in the proper proportions, excess of alkali converts it into the hydroxide, so that soda cannot be used for the preparation of caustic copper emulsion. But if the  $4\text{CuO}\cdot\text{SO}_3$  is precipitated by lime, and then emulsified, the excess of soda may be added without producing any appreciable change; it is only after the lapse of a month or more that an emulsion made in this way will show any signs of the presence of copper hydroxide, and begin to blacken. The difference in behavior, according to which alkali is used for the precipitation, naturally caused much perplexity, until the investigation of the basic sulphates, detailed in a previous communication, had shown that the precipitate with lime is

<sup>1</sup> Pickering: Jour. Chem. Soc., 91, 1997 (1907).

not merely  $4\text{CuO}\cdot\text{SO}_3$ , but a compound of that sulphate with calcium sulphate.

"If fungicidal properties are not required in the caustic wash, ferrous sulphate may be substituted for the more expensive copper sulphate. The emulsions with the iron salt have certain advantages over those with the copper salt. The oil globules in them are smaller (about one-third to one-fifth of the diameter) and the emulsions are more bulky, and separate from the excess of liquid more slowly. Moreover, ferrous hydroxide, unlike copper hydroxide, is itself capable of emulsifying, and hence the precipitation with lime may be dispensed with and the caustic soda alone be used. A much finer emulsion, however, is obtained if lime is used as the precipitant, as in the case of copper. Where soda is used, that required for the precipitation, as well as the extra 2 percent, may all be added to the iron sulphate at once before emulsifying with paraffin. The basic ferrous sulphate, or ferrous hydroxide, as the case may be, is, of course, partially oxidized, and the emulsion becomes nearly black. On keeping it in a closed vessel, it sometimes (especially if excess of lime is present) becomes almost colorless, organic substances in the paraffin apparently reducing the ferric compounds; on exposure to air, it becomes orange-red, ferrous-ferric oxide being formed. These changes do not appear to affect the emulsification.

"One drawback to the copper emulsion is that it cannot be prepared in a concentrated form like a soap emulsion. The percentage of oil present may be increased, but not that of the copper, for lime must be used as the precipitant, and, if this is added to a strong solution of copper sulphate, the precipitated basic sulphate forms a compact mass which will not emulsify the oil properly. With ferrous sulphate, however, where soda can be used as the precipitant, this difficulty does not exist, and it is possible to make an emulsion of which 100 cc contain 60 cc of oil, this being ten times the strength generally required for spraying. The amount of iron which can be got into such a strong emulsion, however, is not large,

and, consequently, the emulsion is light, and rises rapidly to the surface when diluted, necessitating agitation during use.

"Some of the copper emulsions were examined by analysis in the same way as soap emulsions. It will be sufficient to quote the results with one of them only, and these are given in the accompanying table and in Fig. 2. The mixture taken

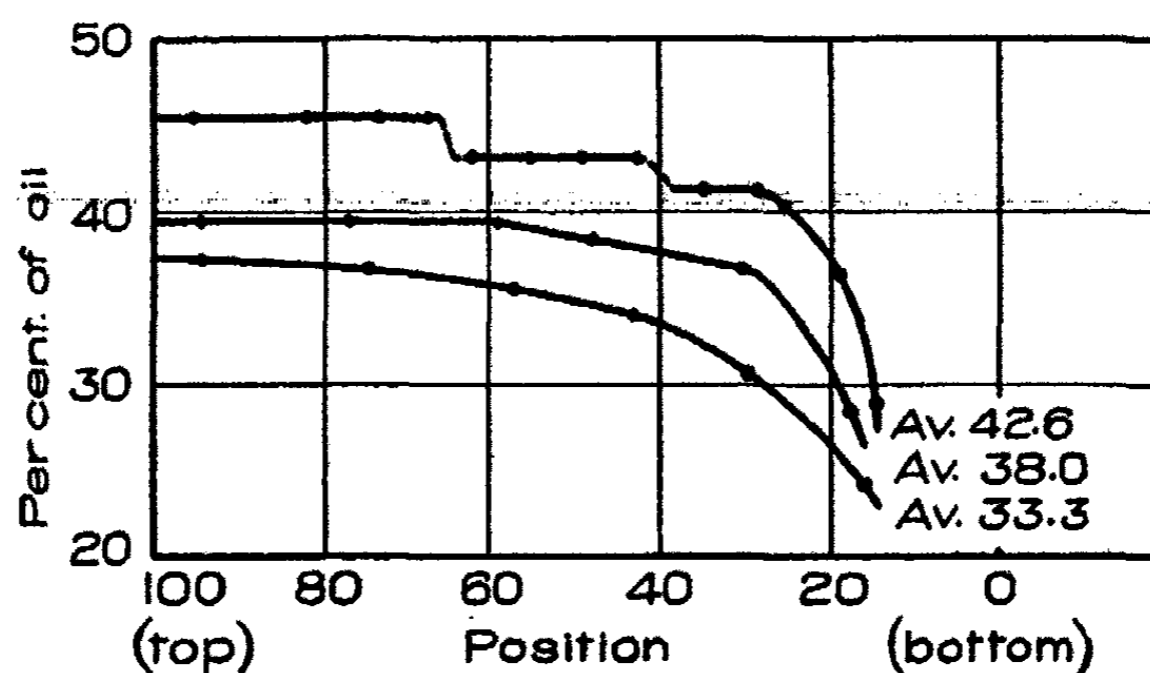

Composition of emulsions. Solar distillate in soap solutions.

Fig. 2

for emulsification contained 20 cc of 'Solar Distillate' and 0.18 gram of CuO, in the form of sulphate, per 100 cc. Portions of the emulsion proper were analyzed throughout their mass after twenty-four hours, ten days, and twelve weeks, the average proportions of oil in them then being 33.3, 38.0 and 42.6 percent, respectively. The emulsion becomes more concentrated as time elapses, and, at the same time, the curve representing its composition becomes flatter, although in all cases there is a rapid fall in concentration towards the bottom of the column. The most marked feature, however, is the ultimate arrangement of the emulsion into layers of uniform composition, which, although not visible as separate layers to the eye, are made evident by the analysis. Such arrangements have already been noticed in the case of emulsions with soap. As will be seen from the table, the percentage of basic

sulphate in the emulsion decreases from the top to the bottom with the percentage of oil, but not so rapidly as the latter,

COMPOSITION OF EMULSIONS OF "SOLAR DISTILLATE" WITH BASIC COPPER SULPHATE

After 24 hours		After 10 days		After 12 weeks			
Position	Percent oil	Position	Percent oil	Position	Percent oil	Percent CuO	CuO : oil
100-83	36.8	100-85	40.1	100-93	45.3	0.408	0.907 : 100
83-66	36.0	85-69	39.9	93-86	43.5		
66-50	35.4	69-53	39.4	86-79	45.3		
50-34	33.5	53-37	38.7	79-72	45.3		
34-19	30.1	37-22	36.7	72-66	45.3		
19-7	22.8	22-8	26.4	66-60	43.4	0.394	0.916 : 100
—	—	—	—	60-53	43.3		
—	—	—	—	53-47	43.1		
—	—	—	—	47-39	43.3	0.378	0.928 : 100
—	—	—	—	39-31	41.3		
—	—	—	—	31-25	41.3		
—	—	—	—	25-22	40.0	0.352	1.071 : 100
—	—	—	—	22-17	37.2		
—	—	—	—	17-11	28.5		

so that the proportion of it to the oil increases downwards. It is noticeable, however, that this increase is very small; in spite of the differences in specific gravities, about 2.5 and 0.86, there is very little separation of these two substances, and the union between them must, therefore, be of a decidedly intimate character.

**The Nature of Emulsions**

"It is evident that emulsions with basic copper sulphate are strictly similar in nature to those with soap, and are quite different from the quasi-emulsions with lime. Many other substances act in a manner similar to basic copper sulphate, but few of them so satisfactorily. The action, however, is not distinctive of basic salts, some of them, such as the basic sulphates of copper, iron and nickel, form true emulsions, whereas those of zinc, aluminum and cadmium form quasi-



emulsions only; other substances when freshly precipitated behave in a similarly arbitrary manner, calcium arsenate, for instance, forms a good emulsion, whereas with barium sulphate, no signs of emulsification are obtained. On the other hand, no connection between emulsification and the nature of the metal present can be traced; copper hydroxide will not emulsify, although the basic sulphate will, whereas both ferrous hydroxide and basic ferrous sulphate are good emulsifiers. Nor is the mere bulkiness of the precipitate any guide to its emulsifying powers; precipitated aluminum silicate, although very bulky, does not emulsify, nor does gelatinous silica. The colloidal condition of the substance, also, has no influence on the results, for paraffin will not emulsify in a dialyzed solution of silica.

"The view which the writer was eventually led to adopt as to emulsification, was that it depended solely on the size of the particles constituting the precipitate. When the oil is broken up into small globules by being forced through the syringe, and these globules find themselves in the presence of a number of very much more solid particles, the latter will be attracted by the globules, and will form a coating or pellicle over the globules, preventing them from coming in contact and coalescing with their neighbors. Whether gravitation alone is sufficient to account for such a result, or whether other forces come into play, must be left for others to determine, but that the solid particles do congregate closely round the globules, there can be no doubt, for they can often be seen under a powerful microscope. With basic copper sulphate this is so, although the particles are so nearly ultramicroscopic that they cannot be resolved sufficiently to admit of any estimate being made as to their actual size; with basic iron sulphate, they are still smaller, and quite invisible, but their aggregation round the globules is evident from the brown ring encircling the latter.

"Further evidence that the globules must be enveloped in some covering is found in the fact that these emulsions do not make the containing vessel oily; indeed, this forms a very

good distinctive test between a true emulsion and a quasi-, or imperfect, emulsion. The same test may be varied by dropping a little of the liquid into a basin of water; if unemulsified paraffin is present, the surface of the liquid becomes oily, but not so if the paraffin is present as a true emulsion.

"An emulsion on this view, however much it is diluted with water, will suffer no de-emulsification, whereas with a quasi-emulsion, where we simply have oil globules entangled with the gross particles of a solid, it should always be possible to separate the greater part of the oil by adding enough water. This, as a matter of fact, is found to be the case. It is also possible to remove the oil from a substance with which it forms only a quasi-emulsion, by adding another substance with which it forms a true emulsion. Thus quasi-emulsion of lime and paraffin of a suitable strength will rise in a mass to the surface of water, but, if some sodium arsenate is added, calcium arsenate is formed, and, as this is a true emulsifier, it forms an emulsion with the oil, and rises to the surface, while the lime, deprived of the oil, sinks to the bottom.

"Neither in the case of a true emulsion nor in that of a quasi-emulsion does the nature of the menstruum appear to have any influence on the emulsification, so long as it does not react chemically with the emulsifier or the oil; a variety of salts may be dissolved in water containing an emulsifier without affecting the emulsion, beyond making it in some cases (notably when caustic soda has been added) more viscid due, no doubt, to an increase in the coefficient of friction. Even strong mineral acids have no effect in a case such as that of clay (some clays will act as emulsifiers), where the solid emulsifier is insoluble in acids.

"Although emulsions and quasi-emulsions are radically different in their nature, various substances will yield results showing every possible gradation between the two, for the simple reason that substances may consist of particles of every gradation of magnitude, some small enough to emulsify the oil globules, and others too large to do more than form quasi-emulsion. In the same way, there is every gradation between

a quasi-emulsion and the complete separation of the oil and water into independent layers.

“The power of emulsifying, not being an inherent property of the substance, but simply depending on the size of its particles, it follows that this power should be destroyed by aggregation; that this is so, can easily be proved. The basic sulphates, calcium arsenate, Oxford clay, etc., all of which form true emulsions, are found to be quite incapable of doing so after they have been dried, however finely they may then be powdered.

“The average size of the globules in an emulsion seems to be dependent on the size of the particles of the emulsifier. Thus the particles of basic ferrous sulphate are more minute than those of basic copper sulphate, and the emulsion is decidedly finer-grained also; with nickel basic sulphate, both the particles and the oil globules are of about the same size as with the copper salt, whereas with cadmium and zinc basic sulphates the particles are gross and the emulsion is very coarse, being to a large extent only a quasi-emulsion. Whether, however, the chemical nature of the emulsifier is altogether without effect on the results or not, and whether the size of the particles is the sole determining factor, it is impossible to decide with certainty, without a more extended series of observations, aided by better eyesight and better microscopic appliances than were available in the present case. It seems, however, that the attraction between the oil globules and the solid particles may be sufficient to modify somewhat the chemical behavior of the latter. The basic sulphate of copper precipitated by lime, when treated with excess of caustic soda, will blacken after a few weeks, owing to the formation of copper oxide, but, when emulsified with ‘Solar Distillate,’ this blackening does not commence nearly so soon; it is more rapid when a lighting oil is used, this forming a coarser emulsion, and much more so if petrol<sup>1</sup> is used, when the emulsification is very imperfect indeed. Similar evidence is obtained by making emulsions with the same oil,

<sup>1</sup> [Casolene.]

but using different proportions of it; that which contains more oil will blacken more slowly. Analogous results are obtained with ferrous sulphate, the color of the emulsions, due to different degrees of oxidation, differing according to the nature of the oil used. It is possible, however, that in these cases the retardation of the action of the soda on the basic sulphate, or the oxidation of the compounds present, may be due to a chemical action of impurities in the oil.

"A few instances exist which seem at first sight to negative the view that the power of emulsifying is conditioned by the size of the solid particles. Thus, precipitated sulphur, purple of Cassius, and ferric ferrocyanide, all of which are in an extreme state of sub-division, will not emulsify paraffin at all. The behavior of sulphur gives a clue to this result. When flowers of sulphur, thoroughly incorporated with water, are churned with paraffin, the latter abstracts the whole of the sulphur from the water, forming with it a greasy mixture, which sticks obstinately to the syringe, containing vessel, etc., the paraffin evidently wetting the sulphur in a way which the water does not. A similar effect is observed in the case of purple of Cassius and ferric ferrocyanide; although the paraffin is not emulsified at all, it abstracts the whole of these substances from the water, becoming intensely colored by them, and leaving the water colorless, just as if they dissolved in the paraffin. The view therefore that emulsification depends solely on the minuteness of the solid particles must be so far modified as to apply only to such solids as are wetted more easily by water than by oil, otherwise there is no emulsification at all.

"The explanation of emulsification here advanced would hardly be acceptable unless it could be applied equally to cases where the emulsifier is a liquid, and there seems to be but little difficulty in doing so; for these liquid emulsifiers are all substances which, under the conditions obtaining, partly separate from the solution, and yield sufficient solid particles to form a pellicle over the oil globules. Liquid emulsifiers are all distinguished, so far as we know, by a feeble

affinity for water; in many cases there are, or contain, protein substances, which, as Ramsden has shown, form a skin of solid matter at any boundary between the solution and another fluid, whether liquid or gaseous. In other cases, the deposition of some particles of the solid would result from this solid being insoluble in the paraffin. The water in the neighborhood of a paraffin globule would become impregnated with paraffin, and the dissolved substance, having but a small affinity for water, would be thrown out of solution. Solutions of egg-albumen, glue and starch, when covered with a layer of paraffin, all form a slight opaque film at the junction of the two liquids. In this way, each globule of oil would obtain for itself the solid particles necessary for its emulsification; but these particles would, no doubt, often be redissolved, while others, in their turn, would be deposited, and, in the course of such changes, opportunities would occur for the coalescence of neighboring globules. This explains why emulsions in soap will generally de-emulsify spontaneously, if left long enough, whereas emulsions with a really insoluble emulsifier seem to be quite permanent.

“Formed in this way by solid deposited *in situ*, an emulsion in soap, or similar substances, would naturally be more fine-grained, and the globules would be more closely packed, than in cases where a separately formed precipitate is the emulsifier. A rise of temperature, or an increase in the volatility of the oil used, would result in the soap solution becoming more permeated with paraffin particles, and depositing more of the dissolved soap, thus facilitating emulsification. With soap, a rise of temperature does facilitate emulsification, and an increase in the volatility of the oil sometimes does the same. With insoluble emulsifiers, however, neither a rise of temperature nor an increase in volatility favors emulsification, indeed, the latter materially hinders it, owing, no doubt, to the more volatile oils being more mobile.

“Whether any soluble inorganic substance exists which would emulsify oil in the same way as does soap, appears to be very doubtful; it is certainly probable that any substance

which is crystalline would be incapable of emulsifying. Saturated solutions of calcium hydroxide and sulphate, as well as of sucrose, dextrose and dextrin, have been tried, with negative results.

"With soap, the particles requisite for emulsification are also provided in another way; for when soft soap is dissolved in much water, or when a strong solution of it is diluted, a considerable amount of a very fine deposit is obtained, and this is often in such a minute state of division that it remains suspended in the liquid for weeks. The separation of this precipitate on dilution, and its redissolution or concentration, explains a fact previously noticed, which otherwise would present considerable difficulty, namely, that for each proportion of paraffin and water the amount of soap necessary for emulsification must not only be in excess of a certain minimum, but also must not be in excess of a certain maximum. The existence of the superior limit is explained if the emulsification depends to any large extent on the presence of solid particles precipitated by dilution, for the tendency to deposit such particles would be less in stronger than in weaker soap solutions.

(It should be mentioned, however, that a superior limit does not seem to exist in the case of all soaps. That is not surprising, for soaps vary largely in composition, even when they are of the same brand, and from the same factory, and they differ considerably in their behavior on dilution.)

"That the formation of a pellicle of solid particles over the oil globules affords an explanation of emulsification, is, as has been mentioned, the conclusion to which Dr. Ramsden also was led, and the view that such a pellicle exists in the case of the oil globules in milk was advocated long ago. So far as can be seen, this view seems to harmonize with all the observed facts.

#### **Behavior of Various Substances**

"It would be tedious and unprofitable to describe at length the behavior of the many substances which have been

examined as regards their emulsifying powers; but they may be briefly enumerated, classing them roughly into those which give true emulsions, those which give imperfect emulsions or quasi-emulsions, and those which do not seem to emulsify at all. In some cases, however, it is rather difficult to decide in which class to place a particular substance, and, in others, the method of preparation affects the behavior of the substance in question.

*“Good Emulsifiers.*—Among soluble, or partially soluble, substances, soft soap seems to be the best; dissolved starch, milk and flour are good, although the latter forms a flocculent, and not a creamy, emulsion, and milk gives rise to solid clots; glue emulsifies well, and so does egg-albumen, but the emulsion with the latter is rather frothy, owing to enclosed air bubbles; saponin and quillaia bark give good emulsions when the proportion of oil present is not large.

“Among insoluble emulsifiers, the basic sulphate of iron is the best, followed by those of copper and nickel; the basic sulphates of zinc and aluminium generally give good emulsions at first, but aggregation of the particle seems to occur, and causes partial de-emulsification. Ferrous hydroxide and the higher oxides of iron (hydrated) are good. The precipitate obtained by adding sodium carbonate to copper sulphate is a very good emulsifier, so are calcium carbonate and calcium arsenate when first precipitated, but the latter soon becomes crystalline, and de-emulsification follows; lead arsenate, freshly precipitated, is good, and zinc oxychloride, or basic chloride, is fair, although the emulsion with it is flocculent; some fine clays (unheated), such as Oxford clay, give good emulsions, but they, naturally, contain many gross particles which sink to the bottom unemulsified; ferrous hydrosulphide gives a good emulsion if the proportion of oil present is small.

*“Substances Producing Quasi-Emulsions, or Producing Partial Emulsions.*—Lime, silica, alumina, plaster of Paris and many fine powders which have been dried; also the following precipitated substances when in the liquids from

which they have been precipitated: basic cadmium sulphate, magnesium hydroxide, copper hydroxide, the basic sulphates of zinc and aluminium, stannous oxychloride, purple of Cassius, lead arsenate paste (a commercial preparation for insecticidal purposes), some clays and brick earths, copper hydrosulphide, ferrous hydrosulphide (unless the proportion of paraffin is very low), and precipitated soda soap.

*"Substances Showing Little or no Power of Emulsifying.—* Precipitated lead chloride, lead sulphate, barium sulphate, neutral silica solution, sulphur precipitated by adding acid to sodium thiosulphate, flowers of sulphur and dried Paris green (in both of which cases the powders seem to absorb the oil, forming a sticky mass which adheres to the syringe and containing vessel in an obstinate manner); an alcoholic solution of resin precipitated by water, ferrous ferricyanide, ferric ferrocyanide, and purple of Cassius (in the last two cases the precipitate is carried up by the oil in sufficient quantities to color it strongly); and, lastly, any coarse, or even fine powders, especially when present in small proportions.

#### **Summary**

"When paraffin oil is churned up with a solution of soft soap, an emulsion is formed which rises to the surface and generally contains 65–82 percent by volume of oil. Emulsions containing as much as 99 percent can, however, be obtained, and these are so stiff as to be almost solid. The character of the oil does not much affect the results, neither does the extent of the churning nor the proportion of soap, so long as this proportion is within certain limits.

"The amount of oil in an emulsion which has arrived at a state of equilibrium decreases somewhat from the top downwards, but there is often a tendency to arrange itself in layers of approximately uniform composition.

"Solutions of other organic substances, such as glue, flour, milk, starch, albumen, saponin, etc., act as emulsifiers for paraffin oil. All these emulsions will often spontaneously become de-emulsified, and this occurs at once if the emulsifier



is destroyed; for example, if an acid or any sodium salt is added to an emulsion with soap. Electrolytes, as such, seem to have no de-emulsifying action. The addition of un-emulsified paraffin to an emulsion will gradually de-emulsify the whole.

“The oil globules in an emulsion are probably prevented from coalescing by being enveloped in a pellicle consisting of particles of solid much more minute than the globules themselves. The solid particles would be derived from the solution, which in all cases contains a substance with but little affinity for water, and insoluble paraffin; it being, therefore, precipitated in the neighborhood of the paraffin globules.

“Apparently, a precipitate consisting of any insoluble substance which is wetted more easily by water than by oil, if in a sufficiently fine state of division, will equally act as an emulsifier, and in some cases it is possible under a microscope to see the coating of solid particles which envelop the oil globules. Emulsions made with an insoluble emulsifier are in every respect similar to those made with soap, etc., except that they never seem to de-emulsify spontaneously, spontaneous de-emulsification being, no doubt, due to the fact that the solid particles, as in the case of soap, are soluble in water, and are continually being redissolved and reprecipitated, thus affording opportunities for the coalescence of the oil globules.

“The basic sulphates of iron and copper are among those substances which give excellent emulsions. They may be formed by adding lime, or lime-water, to the normal sulphates, and then the paraffin, when the slightest churning, or even shaking of the mixture, produces emulsification. Besides the ease of manufacture, and the absence of spontaneous de-emulsification, these emulsions possess the advantage of not being decomposed by the addition of caustic soda, as are emulsions with soap, and caustic soda is required when the emulsion is used as a winter wash for trees. When the copper salt is used, the emulsion possesses all the fungicidal properties of Bordeaux mixture.

"Many other precipitated substances, act as emulsifiers, but this property is destroyed as soon as they have been dried, or have by any other means been deprived of their fine grained structure.

"Solids which are not sufficiently fine-grained to emulsify will, in many cases, when present in considerable proportions, form quasi-emulsions. In these, the particles of oil are merely entangled with the particles of solid, and may be separated from them by such simple means as dilution with water. Lime is an instance of a substance which forms a quasi-emulsion which can be used for spraying purpose. Other substances, including many recently formed precipitates, and, probably, all crystalline solids, seem to be incapable of forming even quasi-emulsions."

Pickering afterwards published a lengthy abstract of this paper<sup>1</sup> in which he added some paragraphs on the effect of surface tension.

"It is generally assumed that the formation of emulsions is dependent on a low surface tension and a high viscosity of the medium.<sup>2</sup> It is clear that a viscous liquid must have a tendency to hinder the coalescence of oil drops; but it is not permissible to attribute to viscosity any really important part in emulsification. Dilute soap solutions are not very viscous and yet their power of forming an emulsion may even be destroyed by increasing the concentration and thereby the viscosity, above a certain point. Hillyer also showed that a very viscous 50 percent solution of glycerine or a 6 percent gum acacia solution did not yield an emulsion. The author has found recently that a perfect emulsion (of potassium cupric tartrate) can be made in a mixture of alcohol and water though this mixture is not viscous at all.

"The surface tension of the medium doubtless plays an important part in emulsification in many cases; but it seems impossible to assume that it is the only, or even the most

<sup>1</sup> Pickering: *Zeit. Kolloidchemie*, 7, 11 (1910).

<sup>2</sup> J. Plateau: *Pogg Ann.*, 141, 44 (1870); Quincke: *Wied. Ann.*, 35, 592 (1888); Hillyer: *Jour. Am. Chem. Soc.*, 25, 511, 524 (1903).

important, factor. In many cases it seems to be of no importance in the formation of an emulsion. This is shown by the recently discovered fact that emulsification may be caused by the mere presence of solid particles, without there being any change in the surface tension of the medium. When we treat such solutions as copper sulphate with lime water, the resulting dilute solutions have practically the same surface tension as water. On the other hand a number of soluble substances have no effect on emulsification. One can even add strong acids without destroying the emulsions provided they do not attack the solid emulsifying particles. This can be realized with certain clays. There are also reasons for considering surface tension as an insufficient explanation even in the case of emulsions formed by means of soap. If we add soap to water and thereby decrease the surface tension of the latter, films of water are formed around the drops of oil and keep these from coalescing. Looking at the matter in this way we should expect that the emulsification would become more perfect, the more concentrated the soap solution was made, since the smallest drops would be emulsified most easily, and the largest ones with the most difficulty. This is not the case, however. There is no emulsification at all until a certain concentration of soap has been reached; but then we get a perfect emulsion at once, whereas we cannot get an emulsion at all when the concentration of the soap goes above a certain limit.

“ We must therefore ask ourselves whether the emulsification of oil in soap solution or in other similar liquids may not be explained more satisfactorily by applying the same principles which have been shown to be found in the case of emulsification by solid particles. It certainly seems as though this presents no difficulties in the case of soap solutions for these are never clear and always contain insoluble particles, notably stearine, which precipitate gradually on standing and more rapidly when the solution is diluted. We have only to assume that the drops of oil are surrounded by the necessary film of solid particles. Since the stearine particles precipitate less

readily as the concentration increases, this accounts for the difficulty that no emulsion is formed after the soap concentration exceeds a certain limit. We know that the drops in such an emulsion are actually covered with some sort of a film because they do not make the containing vessel oily, as is the case when the drops are not emulsified. Even when the soap solution does not contain enough solid particles to coat the drops, it is quite probable that more will be precipitated from the soap solution by the kerosene itself, for Ramsden<sup>1</sup> has shown that, when kerosene is brought in contact with different liquids containing protein substances, an opaque film or membrane is formed at the surface separating the two liquids. The author has found that this also takes place with solutions of starch, glue, albumen, etc. Such a film is probably not stable, but is always being dissolved and then formed again. This gives the drops of oil a chance to coalesce and this may account for the fact that emulsions prepared with soap usually go to pieces when allowed to stand for a long time. On the other hand cracking has never been observed when an emulsion has been properly prepared by means of solid particles (a basic sulphate for instance), always provided that nothing is present which would decompose the solid film.

"The conclusion to be drawn is that emulsification may take place in a liquid when the viscosity is not high and the surface tension is not low, though it is admitted that a high viscosity and a low surface tension often facilitate the formation of an emulsion. The only—or rather the chief—cause of emulsification seems to be the presence in the liquid medium of small, insoluble particles, which form a film round the drops of oil and keep these from coalescing. In order that such particles should have the power of forming an emulsion, they must have only a very slight tendency to agglomerate, they must be more readily wetted by the water than by the oil, and they must not be crystalline."

Donnan<sup>2</sup> comments on this paper as follows:

<sup>1</sup> *Proc. Roy. Soc.*, 72, 156 (1903).

<sup>2</sup> *Zeit. Kolloidchemie*, 7, 214 (1910).

"In a recent article S. U. Pickering discusses the theory of emulsions, and apparently comes to the conclusion that surface tension has very little to do with the phenomenon of emulsification and that emulsions owe their formation chiefly to solid particles. S. U. Pickering has made no accurate measurements on this point and seems also not to know about the close relation between surface adsorption and lowering of the surface tension. He also does not consider the electrical forces which we know to be acting. We do not believe that the true nature of emulsions is to be explained by S. U. Pickering's theory of solid particles."

It does not seem to me that Donnan is quite fair to Pickering in this criticism. It is true that Pickering does not seem to be familiar with Donnan's earlier papers; but it is also true that Donnan has never referred to Pickering's original paper. Donnan himself assumes the existence of a film of soap about the drops of oil in soap emulsion and yet he does not consider that as ruling out electrical phenomena. It is possible that Donnan considers the film as liquid and not solid; but, as Pickering's film is explicitly not crystalline, the question of whether it is a solid film or a liquid film depends upon one's definition of a solid. Pickering has postulated the existence of a surface film in the case of an emulsion; but he has made no attempt to formulate quantitatively all the factors determining the formation and stability of a surface film. Donnan reproaches Pickering with not having made any accurate measurements of surface tension and with ignoring the conditions governing surface adsorption; but this, while true, is not to the point. Donnan has been interested in cases in which there was a real or an apparent connection between the lowering of the surface tension and the formation of an emulsion. Pickering does not deny all this. What he does is to point out that there are cases in which there is no apparent connection between surface tension and formation of emulsion. In this he is entirely correct. There are accurate measurements which show that colloidal ferric oxide has little or no effect on the surface tension of

water.<sup>1</sup> On the other hand hydrous ferric oxide is an excellent emulsifier in some cases. I am quite willing to admit that the discrepancy may be apparent and not real; but it has not yet been explained away and one does not quite see why Donnan should ignore these facts. It is quite true that Pickering has not given us a complete theory of emulsification; but on the other hand he has not claimed to do so.

There are a number of interesting things in Pickering's paper which it will be profitable to consider somewhat in detail. I have already cited the formation of an emulsion with 99 percent of kerosene as the dispersed phase to illustrate the futility of considering an emulsion as necessarily made up of absolutely spherical drops.<sup>2</sup> Curiously enough, Pickering seems to feel that there is or should be something especially significant about a volume percentage of 74.048 percent, which is the percentage volume of the spheres in a collection of closely-packed spheres of uniform size.

In order to get high concentrations of the dispersed phase, Pickering found it necessary to add the oil by degrees. This is a familiar practice in pharmaceutical work where it is even necessary not to reverse the direction of grinding when emulsions are prepared in a mortar. We have confirmed Pickering's results, substituting benzene for kerosene; but I am inclined to think that it is all a matter of inefficient stirring. It is harder to break up a large mass of oil than a small one, and churning with a syringe is not really an effective method. In Robertson's work<sup>3</sup> the shaking was much more effective and he did not have any difficulty in emulsifying high percentages of oil.

Pickering found that satisfactory emulsions could be obtained only between two limiting concentrations of soap, the limiting values varying with the nature of the soap and with the relative volumes of oil and water. According to Pickering the minimum soap concentration increases and the

<sup>1</sup> Freundlich: *Kapillarchemie*, 313.

<sup>2</sup> *Jour. Phys. Chem.*, 16, 179 (1912).

<sup>3</sup> *Zeit. Kolloidchemie*, 7, 7 (1910).

maximum soap concentration decreases with increasing percentage of oil. The minimum concentrations seem to present no especial difficulties. If we postulate that a soap film is essential to an emulsion, it is clear that there will necessarily be some concentration which will behave very much like pure water. Since there are more drops of oil in an oil-rich emulsion than in one containing less oil, it is not surprising that somewhat more soap should be necessary in order to provide for the emulsion. The question of the maximum concentration is a more serious one. It bothered Pickering a good deal as is shown by his attempts at an explanation. I believe that the difficulty lies in the nature of the film around the drops of oil. If the conditions are such that a rigid film is formed instead of a flexible one, it will be ruptured by shaking. Instead of an emulsion, we shall get a coagulation of the soap. When the ratio of water to soap gets too low, we shall have no satisfactory emulsion formed. A consequence of this is that the maximum value for the soap will be lower, the greater the concentration of oil, which is exactly what Pickering found. The agreement is a qualitative one and not a quantitative one because Pickering's maximum value was 25 percent soap when he had sixty volumes of water to forty of oil whereas it was 1.8 percent soap, when he had twenty-five volumes of water to seventy-five of oil. In view of the inefficient stirring I am not inclined to lay much stress on the absolute figures obtained by Pickering. The change in stability when changing from a potassium soap to the less soluble sodium soap is probably due also to a decreased flexibility of the soap films. I have seen emulsions of benzene in water made up with sodium oleate and with a regular sodium soap, containing stearate and palmitate. When first made up, there was little to choose between the two emulsions but the sodium oleate one stood up very satisfactorily for at least six weeks, while the soap emulsion went to pieces within a few days.

The color and viscosity of an emulsion are interesting things. We get the same result with kerosene, benzene, or

olive oil. With high concentrations of the dispersed phase, the emulsion becomes creamy and viscous, finally approaching the consistency of tallow or even of cheese as the concentration gets very high. While it is possible that the smallness of the globules may be a factor in determining the viscosity, I am more inclined to believe that the viscosity of the surface film of soap is the most important item. If we have an infinite number of very small, semi-solid films or membranes, we have practically a cellular structure and consequently the maximum rigidity. The opacity is undoubtedly due to the soap films. That a semi-solid emulsion should gradually liquefy when exposed to dry air is simple enough. The water evaporates from the film and the film coagulates, letting the kerosene run out. It is not quite clear, however, why the edges of the lump should assume the appearance of a slightly transparent, slightly blue jelly on drying; but I imagine that that could easily be accounted for if I knew a little more about the properties of soap. It seems probable that we are dealing with the production of films of transparent soap.

Pickering believes that the emulsions made with basic copper sulphate as emulsifier tend to separate into layers of uniform composition which, although not visible as separate layers to the eye, are made evident by analysis (Fig. 2). I feel certain that this is merely a case of experimental error. The evidence on which the conclusion rests is meagre and unsatisfactory. After standing twenty-four hours, there was no sign of a separation into a series of uniform layers, nor was there after ten days. At the end of twelve weeks, one set of analyses is said to have shown the existence of these layers, each of uniform composition. The experiment was not allowed to run longer, so we do not know whether these alleged three layers persisted or whether their occurrence was purely accidental. The experiment seems never to have been duplicated, which is distinctly unfortunate under the circumstances. It is very doubtful also whether the data, such as they are, bear out the conclusions. Unless there is a



misprint, the uppermost layer varied in composition from 45.3 percent oil to 43.5 percent, while the composition of the next layer varies from 43.4 percent oil to 43.1 percent. I should be inclined to doubt the probability of a misprint because the 43.5 percent point has been omitted from the diagram. It is the only one of the tabulated data which has not been plotted and it looks as though this point had been omitted intentionally because it did not come where it should. The last six analyses gave the figures 43.3, 41.3, 41.3, 40.0, 37.2, 28.5 percent oil. Pickering makes the 43.3 part of the second layer, and he groups the 41.3, 41.3 and 40.0 as a third layer. When these data are plotted by Pickering it is quite clear that five of them lie on a smooth curve, the first 41.3 being below the curve. Pickering evidently draws the tacit conclusion that the 40.0 point is over a percent too low. If we draw the conclusion that this point is approximately right and that the first 41.3 point is over a percent too low, all six points would lie on a smooth curve and the third layer would be non-existent. It must also be remembered that there may be other errors beside the analytical ones. Differences in the sizes of the globules of oil certainly existed and would have some effect. Differences in the subdivision of the basic copper sulphate presumably existed and had some effect. There is therefore no justification at present for assuming that we get discontinuous layers of uniform composition as constituting the final equilibrium when "Solar Distillate" and water are emulsified by means of basic copper sulphate.

Our experiments have not confirmed Pickering's conclusion that once de-emulsification has started, it progresses at an increasing rate. We have had many creamy emulsions from which a little benzene has separated fairly quickly, after which there was apparently no further change for months. On the other hand some emulsions have gone all to pieces soon after they began to crack. The complete breaking down of an emulsion is due to the coagulation of the films surrounding the drops of oil or benzene. Whether such coagulation takes place and how fast it takes place depends on the nature of the

two liquids and on the nature of the substance forming the film. The question of the permanency of an emulsion is a very important one practically; but it can best be considered after we have straightened out the problem of the formation of an emulsion.

Pickering's quasi-emulsions seem to be cases in which the oil has carried the solids into suspension. While there is doubtless some formation of a true emulsion, it seems probable that the adsorption of oil by the solid is also an important factor.

I am inclined to think that Pickering is right in considering the emulsions with basic copper sulphate and basic ferric sulphate as true emulsions. We have obtained similar results using hydrous ferric oxide as the emulsifying agent. I cannot agree with him however in his conclusion that emulsification "depends solely on the size of the particles constituting the precipitate." I cannot understand how he reconciles the following two sentences: "The power of emulsifying, not being an inherent property of the substance, but simply depending on the size of its particles, it follows that this power should be destroyed by aggregation; that this is so, can easily be proved. The basic sulphates, calcium arsenate, Oxford clay, etc., all of which form true emulsions, are found to be quite incapable of doing so after they have been dried, however finely they may then be powdered."

According to Pickering's hypothesis any very finely-divided substances should act as an emulsifier provided it is wetted more easily by water than by oil. In fact he says so definitely. "Apparently, a precipitate consisting of any insoluble substance which is wetted more easily by water than by oil, if in a sufficiently fine state of division will equally act as an emulsifier." If this is true the basic sulphates, calcium arsenate, etc., should act as emulsifiers after being dried, provided they are ground finely enough. Such substances as barium sulphate and lead sulphate ought to act as good emulsifiers if obtained in a fine enough form and yet Pickering himself says that they do not. The important

thing is that we shall have a coating round each globule of oil preventing it from coalescing with other globules. Pickering considers that this coating can be made up of discrete particles, but the experimental evidence does not bear him out in this. It seems to me that the essential thing is to have a coherent film around each globule. In that case it is not enough to have a finely-divided precipitate. It must be of such a nature and in such a state that it can and does form a coherent film around the globules of oil. The conditions for this are still to be worked out. The importance of Pickering's work is that he has shown experimentally that certain precipitates can cause the formation of emulsions even though they have practically no effect on the surface tension of water.

It is interesting to note that Pickering found no trace of an emulsion of water in oil, and that it never occurred to him to turn his definition round. If it is true that one gets an emulsion of oil in water when one introduces insoluble particles which have only a very slight tendency to agglomerate, which are more readily wetted by water than by oil and which are not crystalline, it ought to follow that we should get an emulsion of water in oil if the insoluble particles were more readily wetted by oil than by water.

The general conclusions to be drawn from this paper are as follows:

1 Stable emulsions can be made using as emulsifying agents certain precipitates or suspensions which are known not to have any marked effect on the surface tension of water.

2 The theory of surface tension, as it has hitherto been applied, is not so important for the understanding of emulsification as has generally been supposed.

3 In many cases the existence of an emulsion depends upon the formation of a film or membrane around each globule of the dispersed phase. This does not exclude the possibility of an electrical charge being the whole, or a partial, cause for the drops not coalescing.

4 Though it is often necessary to add the dispersed phase by degrees when working up to a high concentration,

it is probable that this is true only when relatively inefficient methods of dispersion are used.

5 The breaking down of an emulsion is due to the coagulation of the film around the globules of the dispersed phase.

6 It is not true that, when once de-emulsification has started, it progresses at an increasing rate.

7 It is not true that the emulsifying action of insoluble particles depends only on the fineness of division and that it is independent of the nature of the particles.

8 If the concentrations are such that a non-elastic film tends to form, it will be difficult to form an emulsion by shaking. This accounts for Pickering not being able to prepare an emulsion starting with too concentrated a soap solution.

9 The color and viscosity of an emulsion depends very largely upon the properties of the protecting films.

10 The formation of a transparent jelly under the conditions noted by Pickering is probably due to the formation of a film of transparent soap around each globule of oil.

11 It is probably not true that the emulsification of "Solar Distillate" and water by means of basic copper sulphate results in "the ultimate arrangement of the emulsion into layers of uniform composition, which, although not visible as separate layers to the eye, are made evident by analysis."

12 Pickering found no evidence of any emulsification of water in oil.

13 Pickering considers that emulsification will be produced by any insoluble particles in a sufficiently fine state of division, "which have only a slight tendency to agglomerate, which are more readily wetted by water than by oil, and which are not crystalline." This statement is inadequate because it does not state the conditions under which the particles will coalesce to form a coherent film around each globule of the dispersed phase.

14 Pickering does not point out that a corollary of his

hypothesis is that insoluble particles, which are more readily wetted by oil than by water, should tend to promote the emulsification of water in oil.

15 The quasi-emulsions of Pickering are primarily due to solids suspended in oil to such an extent as to make the density approximately equal to that of water. There is probably also some formation of a true emulsion—of drops of oil with a film around each.

*Cornell University*

## SOME LECTURE EXPERIMENTS ON SURFACE TENSION<sup>1</sup>

BY FRANK B. KENRICK

Surface tension affords abundant scope for attractive lecture experiments. The experiments outlined in this paper have been used for many years by the writer, and although less spectacular than many described in the literature, have been found very effective in making clear the principles of surface tension in its application to the chemical phenomena of solubility and adsorption.

1. *Mechanical Model.*—This serves to illustrate the definition of surface tension in work units as the maximum quantity of work that can be gained when a surface is decreased in area by one square centimeter. A projection cell 40 mm × 10 mm and 60 mm high, the upper edges of which have been coated with a film of paraffin wax, is filled almost to overflowing with water. On the surface is floated a thin shaving of cork 30 mm × 5 mm × 1 mm, to which is attached a fine cotton thread about 40 mm long terminating in a little glass hook. The thread passes over a small pulley made from a pill box and a pin resting in a double Y-shaped glass bearing. Three weights of glass or bent wire, weighing about 0.1 gram, 0.07 gram and 0.04 gram may be hung on the hook. The middle weight approximately balances the surface tension, while the lighter one on being pulled down with a pair of tweezers is lifted again by the surface tension. A fall of 1 cc produces one square centimeter of surface: *viz.*, 0.5 cm<sup>2</sup> on the forward under side of the cork which is wet with water and 0.5 cm<sup>2</sup> on the upper surface of the liquid in the cell. The whole of an apparatus of the size described may be pro-

<sup>1</sup> Expts. Nos. 1, 2, 4, 6 and 7 were shown at a local meeting of the American Chem. Soc. at Niagara Falls, January, 1909. 3(a) and 5 at a lecture at the Research Laboratory, General Electric Co., January, 1911, and 3(b) in a lecture by Mr. Howe and the writer at the Washington meeting of the American Chem. Soc., December, 1911.

jected with an ordinary lantern. While quantitative results cannot, of course, be expected, this is a useful experiment to have thrown on the screen when the meaning of surface tension is being explained. The fact is often overlooked that the definition of surface tension as the force acting across a line 1 cc long, etc., presupposes that there is a movable edge of surface to which a weight or other dynamometer can be attached, and that consequently the idea of surface tension at the boundary of a solid is excluded by this definition whereas the definition in terms of work is applicable to every case in which the area of surface can be changed by any reversible process for which the work can be determined.

2. *Two Drops.*—This is analogous to the well known experiment with large and small soap bubbles on the ends of a U-tube.<sup>1</sup> It is the writer's experience that soap bubbles work very well in the preparation room but generally burst at the critical moment in the lecture. Drops of water have not this disadvantage, and are more closely analogous to the chemicals whose behavior this experiment is designed to illustrate. (See 3.) The diagram (Fig. 1 A) shows suffi-

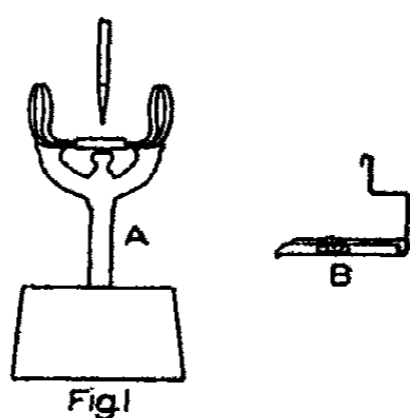

Fig. 1

ciently clearly the arrangement of the apparatus. The upper ends of the capillary tubes should be ground to flat discs about 1.7 mm in diameter and coated with paraffin wax. The two halves of the U-tube are connected by a piece of the fine rubber tubing (0.5 mm bore) used for covering spectacle frames. The U-tube is completely filled with water, and while the rubber connection is closed by pressure with a

<sup>1</sup> C. V. Boys: "Soap Bubbles," 1890, p. 55.

screw driver or other hard object, a small and large drop are piled up on the ends of the tube with a fine-pointed pipette. On releasing the pressure the large drop grows bigger at the expense of the small one. The whole apparatus may be projected with an ordinary lantern, or, if it is made very compact, with a low-power projecting microscope.

3. *Surface Tension and Solubility.*--This is a chemical application of the principle illustrated in Exp. 2. The increase in the solubility of gypsum caused by a fine state of division, first determined by Hulett,<sup>1</sup> may be shown as a lecture experiment in either of the two following ways:

(a) The following materials are required: a "normally saturated gypsum solution," made according to Hulett's method, by stirring gently for some hours about 300 cc water with 30 grams coarsely powdered gypsum, from which the fine particles have been previously rinsed with water. This solution may be kept indefinitely, and shown in contact with the crystals. *Finely powdered gypsum*, made by grinding about a gram of the crystals to an *impalpable* powder in an agate mortar. *Sodium phosphate solution*; a solution is made up containing 100 grams sodium phosphate ( $\text{Na}_2\text{HPO}_4 \cdot 12\text{H}_2\text{O}$ ) and 2.5 grams sodium hydroxide per liter. About 29 cc of this solution (the exact amount must be found by trial) is colored dark pink with phenolphthalein and diluted with water to 100 cc.

The experiment is carried out as follows: To one of two beakers, each containing about 50 cc of normally saturated gypsum solution, is added a pinch (about 0.5 gram) of the finely powdered gypsum. This is shaken for a moment and then both<sup>2</sup> liquids are immediately filtered through previously arranged filters. The first filtrate may be poured through again if not perfectly clear. Twenty cc of each filtrate are then put in two projection cells in the lantern and shown on the screen. On adding 10 cc of the sodium

<sup>1</sup> Zeit. phys. Chem., 37, 385 (1901).

<sup>2</sup> It is best to treat both liquids in exactly the same way, since the point of the experiment is to show a small difference in concentration.



phosphate solution to each cell, the liquid which was shaken with the gypsum turns colorless while the other remains pink. The experiment takes only two minutes to perform; if more time is available for filtration, etc., it may be carried out on a larger scale without the lantern, and an actual titration made, by which a difference of 10 percent can be shown in the concentrations.

(b) The above experiment may be shown more strikingly by the use of an adaptation of Töpler's "Schlierenapparat" to lantern projection,<sup>1</sup> by which concentration streams in a liquid are made visible on the screen. A flat cell containing water, with a transparent gypsum crystal hung just below the surface, is first projected with the lantern. As the gypsum dissolves, a narrow stream of solution is seen flowing down from the lowest point of the crystal. Next the crystal is hung in the normally saturated gypsum solution; no stream is visible. Finally a little glass trough containing a pinch of the finely powdered gypsum is hung in a slightly inclined position in the same cell. In a few seconds a stream of concentrated solution is seen flowing down from the lower end of the trough. The trough may be made by splitting a small thin-walled glass tube and sealing a glass hanger to it as shown in Fig. 1, B.

The writer has tried to show, by this means, the simultaneous solution and crystallization of gypsum in a slightly "super-saturated" solution, but the rate of separation of the gypsum is so extremely slow compared with the rate of solution that streams of weaker solution could never be seen rising from the crystal.

4. *Surface Concentration in Saponin Solution.*—A very simple experiment showing that the surface tension of a freshly formed surface of saponin solution is practically the same as that of water may be carried out as follows. Two beakers are filled to exactly the same depth of about 2 cm—one with water and the other with a saponin solution con-

<sup>1</sup> A description of this will shortly appear in THIS JOURNAL by W. Lash Miller and the present writer.

taining 0.2 gram per 100 cc. A glass tube of 2.5 mm bore and 20 cm long, with the lower end cut off obliquely, is held upright in the water with the end resting on the bottom of the beaker, a piece of thread having been previously tied round the tube to mark the height to which the water rises. The effect of sucking up the water in the tube and letting it fall is first shown on the screen. The same thing is then done with the saponin solution. The liquid drops rapidly as before, pauses a moment at the high water mark and then falls slowly to a much lower level corresponding to the normal surface tension of the solution.

5. *Surface Concentration of Methyl Violet Solution.*—

During the last few years several experiments have been described giving direct evidence of surface concentration in certain solutions, and quite recently Donnan and Barker<sup>1</sup> have made a quantitative investigation of this phenomenon. The surface concentration in methyl violet solution may be demonstrated by the following lecture experiment:

300 cc of an aqueous solution of methyl violet (0.25 gram per liter) are shaken vigorously in a 1 liter separating bulb so as to produce a foam, and then allowed to stand for four minutes to allow the liquid to drain away from between the bubbles. The clear liquid is next drawn off into a beaker and the foam allowed to subside until more than 1 cc of liquid has collected above the tap, which will require perhaps three or four minutes longer. The settlings are then drawn off into a second beaker. By diluting exactly 1 cc of each liquid with 20 cc of water, and placing the diluted liquids in a double glass cell (1 cm thick) before the lantern, the color of the foam settlings is seen to be slightly, but unmistakably, darker than the unfoamed liquid.

The time required for the foam to subside varies. If it should take too long the process may be hastened by gentle stirring, through the mouth of the separating bulb, with a glass rod moistened with amyl alcohol. This amount of amyl alcohol does not itself affect the color of the liquid.

<sup>1</sup> Proc. Roy. Soc., 85 A, 557 (1911).

6. *Emulsification of Oil by Potash.*—This may be shown rather strikingly as follows: A strip of fine copper or iron gauze is folded on itself four or five times so as to make a pad which fits into the bottom of a projection cell (1 cm thick). About 20 drops of olive or linseed oil are allowed to soak into the gauze pad from a pipette, care being taken to keep the sides of the cell free from oil. The cell is then filled about 4 cm deep with water. When this is projected on the screen the oil is seen protruding in little humps through the meshes of the gauze, but the water-oil surface tension prevents it floating up through the water. Directly a little potash solution is added to the water the humps of oil elongate and flow in a number of thin streams to the surface where they form an emulsion.

7. *Oil-films on Water.*—This experiment shows that the action between oil and water is purely a surface phenomenon. A glass rod, round which is stuck a label rubbed with linseed oil, is supported about 3 cm above the bottom of a 300 cc beaker. Tap water is allowed to run into the beaker and flow over the edges until the surface is clean enough to show camphor movements. If the beaker is placed in front of the condensing system of a lantern, with the surface of the liquid well above the centre of the field, the moving camphor can be plainly seen on the screen. If, now, bubbles of air are blown into the water from a clean tube they have no effect on the camphor movements so long as they do not touch the oil, although they stir the liquid, but as soon as they are allowed to brush up past the rod the movements cease.

*University of Toronto, Chemical Laboratory,  
March, 1912*

## LANTERN EXPERIMENTS ON REACTIONS IN NON-HOMOGENEOUS SYSTEMS<sup>1</sup>

BY FRANK B. KENRICK

The use of graphs for expressing experimental relations has done much to simplify the teaching of general chemistry. A good diagram not only gives a concrete picture of a relation abstracted from tables of numbers but possesses also a peculiar fascination of its own for the average mind. A research student experiences a feeling of elation over his first experimental graph that is rivalled only by the sense of proprietorship of the organic chemist towards his first "new body." But in this very fascination there is a pedagogical danger. As the student's enthusiasm for the diagrams increases his interest in the troublesome chemicals often wanes; he begins to talk of melts moving along curves as if they were baseballs and to think of common salt existing in "fields" instead of in the sea.

To offset these dangers it has become the custom to draw diagrams of pistons and cylinders alongside the graphs, in the hope of keeping the balance between experiment and representation. With the idea of making these conventional cylinders and pistons more realistic the writer has used actual tubes containing the chemicals which may be thrown on the screen as working models.

The main difficulty in these experiments is in making an air-tight frictionless joint between the piston and cylinder. The only packing that the writer has found practicable is mercury, and since the leakage is prevented only by surface tension the pressures must be limited to comparatively small values. The four following experiments illustrate the use that may be made of these models.

<sup>1</sup> These experiments were shown for the first time at the Washington meeting of the American Chemical Society, December, 1911, in a lecture by Mr. H. E. Howe and the writer. The excellent Bausch & Lomb Convertible Balopticon was used in all the experiments; the arrangement of apparatus described in Nos. 5 and 6 applies particularly to this lantern.

1. *Boyle's Law.*—*A* is the cylinder tube (Fig. 1) in which the piston *B* fits loosely but closely. Both *A* and *B* are

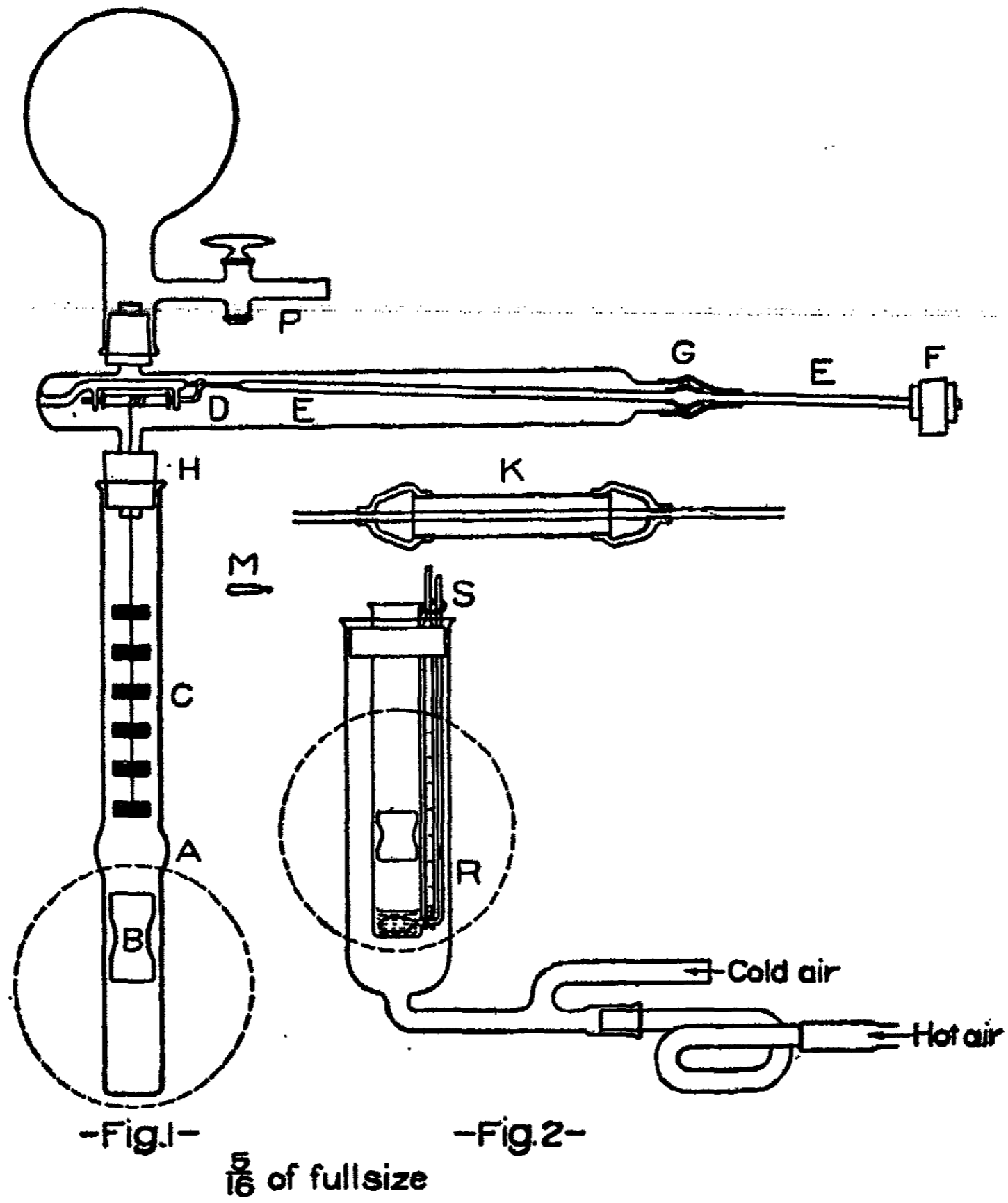

flattened at the bottom for appearance sake. *C* is a string of lead weights (10 grams each), hung on a piece of cotton thread, the upper end of which is wound round the glass

winch *D*. The point of the rod *E* fits loosely into the little ring on the handle of the winch, which may be turned by moving the weight *F* in a small circle, there being a sufficient play at *G* to allow a slight side motion.

The apparatus is all put together with the exception of the joint *H*. The tube and piston are thoroughly cleaned and dried and about 7 mm of mercury is poured into *A*. A little bulb, *M*, open at one end and containing air, is dropped in and then the piston is inserted and pushed right down until enough mercury has been squeezed up to fill the waist. After connecting at *H* the apparatus is exhausted through *P* by an air-pump (a filter-pump is hardly sufficient). The air contained in the little bulb gradually expands and lifts the piston to the weights. If one weight is not sufficient to balance the pressure when the piston is at the edge of the field of the lantern, shown by the dotted line, the weights are cautiously raised till the piston reaches the expansion in the cylinder, when a few bubbles of air may be allowed to escape past the seal.

When the weights are lowered the piston should go down smoothly, a definite, but decreasing, distance for each additional weight. If it sticks it means that either the tube or mercury is dirty. A well selected piston of the dimensions shown will support a weight of 200 grams, without the seal giving way.

A few points may be noted in regard to making the apparatus. A length of tube is selected first for the cylinder by running a pair of calipers over the stock of glass. The exact size is less important than uniformity of bore. In choosing the piece for the piston it will generally be found that if the end of a stick of glass fits approximately, there will be one piece in the stick of the right size. A number of pieces about three inches long should be corked at one end and dropped into the closed cylinder. One that falls slowly as the air escapes and shows no tendency to stick, even when turned through various angles, should be chosen. In making the waist in the piston a rod should be sealed through the

tube as shown in Fig. 1, *K* and the whole rotated in a small hot flame. In this way the two ends are kept exactly concentric.

The lead weights should be painted with melted sealing-wax, otherwise they are sure to become amalgamated by the mercury and the mobility of the seal is spoiled. They may be strung on a thread, in which knots are tied at intervals, and made fast by pressing the lead round the thread with a pointed tool. A little hook on the barrel of the winch catches a loop in the end of the thread, which can be poked up through the tube at *H*. The weight *F*—a cork with a strip of lead round it—prevents the winch from unwinding. The rubber joints may be made tight with tap-grease.

When once set up the apparatus may be kept for a week or more ready for use, but requires occasional re-exhausting.

2. *Vapor Pressure*.—The apparatus is similar to that used in Exp. 1. The little bulb, *M*, is filled completely with freshly boiled water (which has just the right vapor pressure for the apparatus) and mercury is squeezed into the seal as in Exp. 1. In exhausting the apparatus water vapor should be allowed to bubble through the seal at the expansion until about half the water has evaporated out of the bulb, so as to get rid of the small quantity of air always left in the corners. If the water is not freshly boiled it is apt to flow out of the bulb on exhausting, and the bubbling past the seal becomes too violent and uncontrollable.

The piston should go smoothly up and down on lifting or adding one extra weight. By gently warming the tube by the hand or by a small flame more weights are lifted.

When freshly filled this apparatus works admirably, but after a day or so the piston is apt to stick slightly at the position in which it has been left. The writer has found it better to rub out the cylinder with a *slightly* oily cloth. The water vapor then always condenses on the mercury and not on the sides of the glass, and if the piston is left down when not in use the sticking is avoided.

3. *Vapor Pressure and Temperature*.—Several very in-

structive experiments may be made at atmospheric pressure with a simpler form of apparatus. See Fig. 2. The cylinder and piston may be made from two carefully selected test tubes, though closeness of fit is not so necessary as in the previous experiments. A bulb about the size of a pea on the end of a thin-walled capillary tube sealed through the cylinder near the bottom serves as an air-thermometer, the temperature being registered by the height of a drop of mercury, *R*. The upper end of the thermometer is protected from breakage by the hook of glass *S*, which also serves to hold the scale, made by drawing out a microscope slide and marking the figures with india ink.

Enough alcohol, or other liquid, to cover the thermometer bulb is poured into the cylinder without wetting the sides. By holding the piston about half way out of the top of the cylinder mercury may be poured into the seal. If the tube is then slightly inclined the piston may be pushed slowly down to the alcohol while the air bubbles up through the mercury. A small bubble of air should be left to prevent superheating. The top of the piston must be slightly turned in, to prevent the mercury bubbling over into the hollow of the piston.

The cylinder is hung loosely in a larger thin-walled tube, 4 cm in diameter, as shown in the diagram. The temperature can be slowly raised or lowered by a current of air, the heat being conveniently supplied by a heated copper tube, as shown, attached to the glass by asbestos paper. On raising the temperature to a certain point the piston rises; on cooling a few degrees it drops back. The thermometer scale need be graduated only very roughly as long as the 78 mark corresponds to the temperature at which the piston goes up. The superheating of a liquid may be shown, if, during the heating, the piston be pushed down several times so that the alcohol vapor bubbling through the seal carries out the remaining air. After now completely condensing the vapor the liquid may be heated well over the boiling point, until the piston is suddenly driven violently up to the top of the cylinder.



4. *Decomposition Temperature.*—The decomposition of powdered calcium chloride ammonia may be shown in the same apparatus as used in 3, but to get a reasonably sharp temperature the air must be expelled from the powder by pushing the piston down several times during the heating. This, however, must be done at the time of showing the experiment; for if the tube is once allowed to cool after the air is expelled the mercury will be sucked down from the seal into the powder.

It may be mentioned that in the last two experiments the thermometer must be inside the cylinder, because otherwise, unless the heating is very gradual—and this takes too long for a lecture experiment—the thermometer would become heated much more rapidly than the liquid. The use of a water bath to supply the heat is excluded by the refraction of the water. The apparatus is, no doubt, capable of further application, but it may be noted that subliming solids condense on the glass and cause sticking.

5. *Delayed Reactions.*—In connection with the superheating of the alcohol in Exp. 3, the analogy between the crystallization of a supersaturated solution on nuclei and the reduction of silver salts in photographic development may be shown as follows. The experiments have nothing to do with pistons and cylinders but may properly be described under the title of this article.

After placing a crystallizing dish in the vertical attachment of the lantern the bottom of the dish is written on with a crystal of copper sulphate. Although nothing is visible on the screen the writing may be "developed" by pouring into the dish a supersaturated solution of copper sulphate, made by cooling a solution saturated with this salt at 45° C to the ordinary temperature.

The experiment may be varied to show the meaninglessness of the use of the term "saturated solution" without specifying the substance in respect to which it is saturated. "Copper chloride" for example may be written on the dish with an alcoholic solution of copper chloride and allowed to dry, while "copper sulphate" is scratched over it with a

crystal of copper sulphate. On developing with the copper sulphate solution the words "copper chloride" are replaced by "copper sulphate."

It may not be generally realized that a solid projection lantern serves as an excellent lecture-room camera. In fact, the whole process of exposure, development and projection of the negative may be carried out in the lantern in less than three minutes. The lantern is focussed for the solid projection of a crystallizing dish, an orange screen<sup>1</sup> and an opaque card being placed between the projection cabinet and the lamp. A second lantern is arranged to give a "spot-light" on the screen in the exact position of the image of the crystallizing dish. A disc of developing paper (special velox) is placed in the dish and held down by a ring of glass. The subject to be photographed stands, or is placed, against the screen in the spot-light. After a sufficient exposure—about two minutes if the lantern is not too far from the screen—the spot-light is turned off and the opaque card drawn out of the other lantern, showing the dish and plain paper on the screen. A few seconds later the developer should be squirted into the dish through the peep-hole in the lantern box, and then the hypo solution, as soon as the image appears on the screen.

6. *Arrangement of Lantern.*—In the projection of glass apparatus the best results are obtained by placing the object in parallel light close *behind* the condensing lens *A*, Fig. 3. A convenient arrangement for the lantern for general purposes is shown in the same diagram. The two large mirrors on the stand *B* in front of the lantern rectify the image and throw it on a screen on the right hand wall of the lecture room. By reversing the positions of the mirrors *C* and *D*

---

<sup>1</sup> I am indebted to Professor A. H. Abbott, University of Toronto, for the following receipt for an excellent light screen. Three photographic plates are washed in hypo and dyed respectively with quinoline yellow, Indian yellow and methyl violet. The first two should be dyed as dark as possible, but the third should be only a faint violet shade. The three plates are used together.

in the vertical and solid projection attachments<sup>1</sup> the images from these are also thrown to the right. The "Schlieren" apparatus (see footnote, Exp. 3, *b*, preceding article) may be used, at the same time arranging the lenses to the left of the lantern. By simply sliding the large mirrors *B* out of the way the image

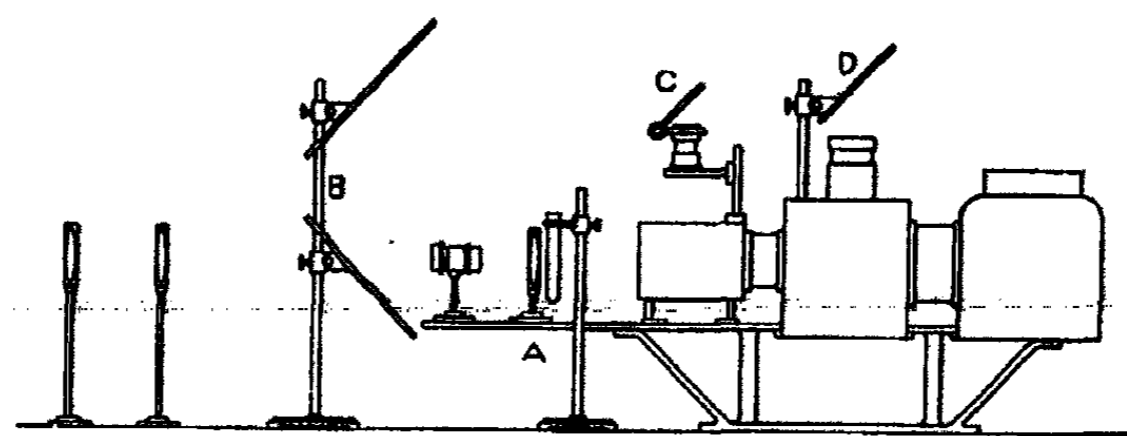

Fig. 3

is thrown on the left wall of the lecture room. The lantern may be placed well to the right of the lecture table, thus giving the necessary distance between screen and lantern required by the "Schlieren" apparatus.

*University of Toronto, Chemical Laboratory,  
March, 1912*

<sup>1</sup> Messrs. Bausch & Lomb will supply their Convertible Balopticon with the slight modifications required for reversing the position of the mirror *D* and detaching the lens *A* from the vertical attachments.

## NEW BOOKS

**Storage Batteries.** By Harry W. Morse. 19 × 12 cm; pp. 266. New York: The Macmillan Company, 1912.—Preliminary to the discussion of the lead accumulator, with which this little book is primarily interested, the author takes up a discussion of several of the fundamental concepts of electrochemistry. After a few pages on the history and development of the lead cell, Faraday's laws are briefly explained, electrical and electrochemical units and terms are defined; the phenomenon of electromotive force, ionization, and the mechanism of electrolysis are considered briefly.

The reactions during charge and discharge of the lead cell, the ions in the solution, and their transfer, are then discussed. The assumption, that the ions at the lead dioxide plate are  $PbO_2$ , is hardly warranted in the absence of definite proof, considering acid solution. In view of the fact that from the standpoint of a workable hypothesis, the tetravalent lead theory seems to present the fewest objections, it would have been better had the author said frankly that it is not definitely known what the intermediate reactions are at the lead dioxide plate.

The energy of the reactions which occur in the storage cell is considered in a chapter, where the electromotive force is calculated from the heat tone of the reaction. The effect of concentration of acid on the electromotive force and the total energy available in the cell is then deduced. The theory of electromotive force is then considered, the Nernst formula is deduced, its application to the lead accumulator is shown, and the theories of LeBlanc and Liebenow are stated a little more fully than before. Time voltage curves are then shown, for charge and discharge, giving the effect of concentration of acid, temperature, rate of charge and discharge, and types of plates. The cadmium tester is mentioned. The factors determining capacity, diffusion, porosity, and reaction velocity, and the effect of temperature and concentration, on these factors are noted. Peukert's formula is given, which allows the calculation of the capacity at different rates of discharge. Current and energy efficiencies, internal resistance, sulphation and the physical characteristics of the accumulator then receive attention. The author presumably is not familiar with the recent work on the regeneration of sulphated cells.

Formation of the Planté plates by reversals, and by the addition of forming agents; of the paste plates; diseases and troubles, covering presence of impurities, shedding, buckling sulphation, local short circuits, and general debility; and a set of rules for operation of accumulators are discussed. The author is correct in saying that cells do not sulphate when used often, and properly charged, but he is wrong in intimating that sulphation is obsolete.

As commercial types the Tudor, Gould, National, Manchester, and box types of plates are given. The uses of cells are discussed briefly and finally a very brief description of the Edison cell is given with a short comparison of the merits of the two cells.

As a whole the book is very interesting, and contains a great deal of information which is valuable. The material, however, is not presented as logically as it might be.

C. W. Bennett

**Physico-Chemical Calculations.** By Joseph Knox. 12 × 19 cm; pp. 186. London: Methuen & Co. Ltd., 1912. Price: 2/6.—“The collection of physico-chemical problems is based on Abegg and Sackur's *Physikalisch-Chemische Rechenaufgaben* [author's capitals]. The original intention was simply to translate the German book, which consists of a short summary of the laws and formulae used in the problems, and fifty-two typical problems, with full solutions. With the consent of the late Professor Abegg and of Dr. Sackur, however, I decided to arrange the subject-matter in chapters dealing with the main subdivisions of physical chemistry, and to write a short introduction to each chapter, dealing with the theory involved in the problems. Most of the problems in the 'Rechenaufgaben' have been retained, a good many additional solved problems have been introduced, and a collection of problems for solution (with answers) has been added at the end of each chapter. The size of the book has thus been more than doubled.”

Wilder D. Bancroft

**L'Evolution de l'Electrochimie.** By W. Ostwald. Translated by E. Philippi. 11 × 19 cm; pp. 266. Paris: Félix Alcan, 1912. Price: 3.50 francs.—In the first chapter Ostwald makes a strong plea for the study of the historical development of chemistry. He points out that it is not enough to know the facts and laws established by the pioneers. That is important, of course, but it merely tells us what is already accepted as dogma. It is also desirable to learn what has been overlooked by the writers of text-books. The case of Grotthuss is an instance, though not cited by Ostwald. His views on the chemical action of light were not appreciated by his contemporaries and it was not until the papers were republished in Ostwald's *Klassiker* that people learned that Grotthuss had given a formulation of the laws of photochemistry, which was not improved upon during the whole of the nineteenth century.

In the remainder of the book Ostwald gives a sketch of the development of electrochemistry from Priestley to J. J. Thomson. The arrangement of the subject is interesting: prehistoric electrochemistry; Galvani and Volta; Ritter and Davy; from Faraday and Daniell to Hittorf and Kohlrausch; electromotive forces; the first stages of technical electrochemistry; van't Hoff and Arrhenius; the ionists; modern technical electrochemistry; the electron. W. D. B.

**Higher Mathematics for Chemical Students.** By J. R. Partington. 23 × 22 cm; pp. 264. New York: D. Van Nostrand Company, 1912. Price: \$2.00.—In this book the illustrations are taken almost exclusively from chemistry. Thus the gas law illustrates functions; reaction velocity, the rate of change of a function; washing precipitates, the differentiation of algebraic functions; an atomic weight determination, the maximum or minimum values of a function; Stefan's law, the exponential and logarithmic functions; a boiling-point curve, the partial differential coefficients; change of the specific heat with the temperature, interpolation and extrapolation. Under indefinite integrals we find reaction velocities in heterogeneous systems; under definite integrals the work done by an ideal gas; and under differential equations we get radioactive changes. This seems to have distinct merits though it has the disadvantage of presupposing that independent courses in the calculus are to be given by each department in a university. As supplementary reading to a course in advanced theoretical chemistry the book will be very valuable.

Wilder D. Bancroft

## THE PERMANENCY OF PAINTINGS<sup>1</sup>

BY WILDER D. BANCROFT

When light is absorbed by a substance, the substance tends to change and consequently there is a tendency for light to affect all pigments. Since the light produces but a relatively small change in the chemical energy, it depends on the special conditions whether any given pigment is affected or not. There is no particular type of reaction produced by light of any given wave-length. It is not true, for instance, that the blue rays have a reducing action and the red rays an oxidizing action. Light may cause or accelerate an oxidation, a reduction, an allotropic change, a dissociation, a condensation, or a metathetical reaction. The change that takes place depends entirely on the chemical conditions prevailing while the pigment is exposed to light. Methylene blue, for instance, may fade as a result of reduction<sup>2</sup> or of oxidation. The bleaching of methylene blue is usually an oxidation because of the oxygen in the air. In presence of gelatine<sup>3</sup> or of stronger reducing agents the bleaching of methylene blue by light is due to a reduction. On standing in the dark the leuco base is oxidized and the color comes back.

In the case of water colors, the change due to light is usually an oxidation. It seems possible that the rapid fading of water colors may be due in part to the gum<sup>4</sup> acting as an oxygen carrier. This should be looked into, because it might be possible to use some substitute for gum which would not produce such harmful results.

With oil paints we may get a reduction in case the oil contains a drier. The drier acts as an oxygen carrier to oxidize the oil. In addition to taking oxygen from the air, it may re-

<sup>1</sup> A paper read before the Eighth International Congress of Applied Chemistry in New York, September, 1912.

<sup>2</sup> Cf. Wander: Jour. Chem. Soc., 66, II, 122 (1894).

<sup>3</sup> Gebhard: Zeit. phys. Chem., 79, 639 (1912).

<sup>4</sup> Cf. Struve: Liebig's Ann., 163, 160 (1872).

duce the pigment, especially if the supply of oxygen be limited. We get an admirable instance of this with Prussian blue.<sup>1</sup> "When Prussian blue or any of its analogues are mixed with white lead or flake white, the rich sky blue or greenish tint, which will result, bleaches over night into a sickly green; but, on exposure to the light for an hour, it comes back to its original color."

Here the white lead acts to a certain extent as a drier. Under some conditions a slight reduction of ferric oxide takes place.<sup>2</sup> "Upon long and extreme exposure the bright Indian red loses its brilliancy and turns darker, which is due to the chemical change or decomposition from the ferric to the ferrous state. The ferrous [ferro-ferric] oxide of iron is a black oxide with which the artistic painter is not acquainted. The ferric oxide of iron is the bright, red oxide. The darkening effect of Indian red is due to the slight change from the ferric to the ferrous [ferro-ferric] oxide. The same is true when Indian red is mixed with zinc oxide to produce a flesh tint. The author exposed a sample so made for three years to the bright daylight, and at the end of three years a very slight darkening had taken place; but, inasmuch as artistic paintings are rarely, if ever, exposed to the bright sunshine throughout the entire year, Indian red must be regarded as one of the permanent and reliable pigments." Toch<sup>3</sup> also states that "driers decompose many pigments. In fact, nearly every one of the lake colors is rapidly affected by the action of driers. Madder lake, when mixed with a lead or manganese drier soon loses its pristine brilliancy." In presence of oxygen the drier oxidizes the pigment. In presence of oil and only a slight amount of oxygen, the drier reduces the pigment and oxidizes the oil.

With vermilion we have an allotropic change from the red form to the black. It appears to take place more readily

<sup>1</sup> Toch: *Materials for Permanent Painting*, 132 (1911).

<sup>2</sup> Toch: *Ibid.*, 132 (1911).

<sup>3</sup> *Materials for Permanent Painting*, 75 (1911).

in water colors<sup>1</sup> than in oils. "In water-color painting most vermilions are found to be changed on exposure, the solar rays gradually converting the red into the black modification of mercuric sulphide, without, of course, producing any chemical alteration. This change occurs even in the absence of air and of moisture. Impure air, *per se*, even if sulphuretted hydrogen be present, does not discolor vermilion.

"Anyone who has examined old illuminated manuscripts must have noticed the apparent capriciousness with which the ornaments, and especially the initial letters, painted with vermilion, have been affected. I have more than once observed that, while all the vermilion used in one part of a missal or choral-book has remained red, a leaden hue has spread irregularly over the rest of the work in places where this pigment has been used. This may be due to the use by the illuminator of a sample of vermilion adulterated with minium or red lead, but sometimes to a change in the technique, as a change in the style or handiwork is often associated with the difference above described. In oil-painting there are no permanent pigments, save the copper-greens, with which vermilion may not be safely mixed. Only when it contains impurities, such as free sulphur, does it darken flake-white.

"Vermilion prepared from native cinnabar is found perfectly preserved in the flesh-tints of Italian tempera-paintings of the thirteenth and fourteenth and fifteenth centuries. It has stood in the wall-paintings of Pompeii, where it often seems to have been waxed. A comparatively recent but instructive instance of the permanence of vermilion in oil is furnished by a portrait, dated 1758, in the National Museum Gallery. It represents the painter, Hogarth, with his palette set before him. The second of the dabs of color thereon is vermilion, perfectly intact. In the same collection there is a portrait by Marc Gheeraedts of Mary Sidney, Countess of Pembroke, in which the vermilion has stood. This work was painted in 1614. Scores of earlier and later examples might

<sup>1</sup> Church: *The Chemistry of Paints and Painting*, third edition, 169 (1901).



be cited." Since the discoloring of vermilion is an allotropic change and is therefore independent of other reagents, it might seem as though vermilion ought always to be stable or always to be instable. I shall take this point up later when considering methods of preventing the light from changing pigments.

The case of carmine presents certain difficulties. There is no question but that carmine is instable in light. Church<sup>1</sup> says that "beautiful and rich as are the colors prepared from cochineal, not one of them should ever find a place upon the palette of the artist. They all become brownish, and ultimately almost disappear after a short exposure to sunlight or the more prolonged attack of strong diffused daylight. In six hours of sunshine a strong wash of fine crimson lake on Whatman paper lost 8 percent of its original intensity; this was on April 12. The loss during a second period of six hours' exposure was much less, but after the lapse of four months less than 5 percent of the original color remained. In the case of carmine, from one to two years was required for the complete obliteration of every trace of the original crimson from a deep wash of this pigment. All the cochineal pigments become somewhat brownish during the course of fading, but ultimately, when all the red has disappeared, either a greenish grey or a faint sepia-like brown is the sole residue."

Notwithstanding this evidence as to the instability of carmine there exists a tradition that a first-class grade of carmine can only be made in sunlight.<sup>2</sup> Never having seen carmine made, I do not know whether this belief is erroneous or what the explanation is in case the belief is true. The only guess which occurs to me is that the raw carmine contains some impurity which is more readily destroyed by sunlight than the carmine itself.

The permanency of pigments in light is complicated by

---

<sup>1</sup> *The Chemistry of Paints and Painting*, third edition, 186 (1901).

<sup>2</sup> *Bersch: Manufacture of Mineral and Lake Pigments*, 358 (1901).

the presence of gases in the atmosphere.<sup>1</sup> "In all large communities there exists sulphuric acid in the air, and many colors which we have regarded as permanent to light, are not permanent to the effect of acid gases. In a general way this rule applies also to the colors affected by sulphuretted hydrogen. If we take, for instance, red lead, which is the red oxide of lead, and expose it to the air of a city it apparently bleaches white. The same red lead when varnished and covered with glass may be exposed for ages and will not be affected. We note the former change particularly on steel structures like bridges, which have been painted with red lead and on which the color sometimes bleaches from a pure scarlet to a pale pink. On rubbing such a surface with linseed oil and turpentine the original color comes back in all its brilliancy. Upon investigation, we find that the sulphuric acid and red lead formed a minute crystalline surface of sulphate of lead, which is white. Chrome yellow will be affected in the same way. Improperly washed Prussian blue will likewise bleach, and flake white is affected in identically the same manner, with the exception, that the change cannot be noted by the eye, but if a flake white surface, which has been exposed to the elements, is rubbed with a black cloth, a white chalky deposit will stain the cloth. This is known as chalking, and mural decorations which cannot very well be varnished and protected, should therefore be executed with pigments that are not affected by the acid gases of sulphur. Nearly all the pigments are affected, with the exception of the blacks. The ochres, siennas and the earth colors, which are exceedingly permanent, show this defect although to a less degree as compared with the chemical colors like Prussian blue, the lakes, cadmium yellow and the lead colors; but paintings which are kept in a pure atmosphere under glass are necessarily preserved, and water colors are more susceptible than any other form of painting."

The blackening of white lead by hydrogen sulphide can

---

<sup>1</sup>Toch: *Materials of Permanent Painting*, 181 (1911).

be counteracted to some extent by exposing the lead sulphide to light and air, in which case it is oxidized to lead sulphate.<sup>1</sup>

My attention was directed to the action of light upon the sulphide of lead from observing that in the glass cases in the Technological Museum under my charge at the Crystal Palace, which are painted white with white lead, substances which emitted sulphurous vapors did not cause a darkening of the surface of the case, except where it was protected from the direct influence of light.

"In the case devoted to sulphur, for instance, the spaces obscured by the descriptive cards alone were blackened, the white color of the rest of the case being unimpaired. In the cases containing vulcanized rubber, wools, woolen fabrics, hair, and other animal products containing sulphur, the same appearances were presented.

"In the first-named of these cases I had placed the dried leaves of the gutta-percha plant, attached to a piece of cartridge paper—a translucent substance. Upon removing the paper I found a tolerably faithful photograph of the leaves upon the surface of the case.

"In order to verify these observations, and to gain a knowledge of the cause and rapidity of the action, and at the same time to ascertain the effect of the colored rays upon sulphide of lead, the following experiments were made:

"A board painted white with white lead and oil was exposed in a chamber for several hours to the action of sulphide of hydrogen gas until the painted surface had acquired a nearly uniform chocolate or deep-brown hue. Plates of glass of different colors were then placed upon the painted surface, one portion being at the same time covered by an opaque medium, and another left open and unveiled to the light. The board was then placed in a situation facing the east.

"The glasses which I employed were of the following colors and properties: 1, red; 2, blue; 3, yellow; 4, violet; 5, a glass that diminishes the intensity of all the rays; and 6,

<sup>1</sup> Price: *Jour. Chem. Soc.*, 18, 245 (1865).

a glass which slightly reduces the yellow ray. My friend, Mr. Robert Hunt, F.R.S., was kind enough to lend me the series of colored glasses which he employed in his investigations, for the British Association, and the optical properties of which he had determined; but, with the above exceptions. I have not thought it requisite to record the results obtained, desiring rather to view the subject from a practical point. The results shown are from an exposure of eight days, on one of which only was the atmosphere clouded. It will be observed that the surface exposed to the action of light is now perfectly white, while that under the influence of the red ray remained as dark as where the sulphide had been protected from light. The blue ray has effected an almost complete conversion of the sulphide; the yellow ray a partial, and the violet considerably less action than the yellow. The light passing through glass 5 has produced somewhat less effect than has resulted from the blue rays, while with glass 6 the action has been nearly as rapid as where the surface has been left quite exposed to the light. The action of drying oils is very rapid upon sulphide of lead, an exposure to light for a few days, only being sufficient to change a surface of it coated with a thin layer of linseed oil into a white one. When boiled linseed oil is used, still less time is required to effect the change. That the action is an oxidizing one there can, therefore, be little doubt, and I regret that I have not been able to get the further proofs on this point ready for this occasion, but knowing that there are many in Birmingham who might be interested in the subject, I have thought it better not to defer the communication of these results on that account. It is, however, not only when mixed with oil that the conversion of the sulphide is accomplished, for where water color was used, the action was still marked, although slow, as will be seen by the illustration exhibited in which the dark spaces were protected from the light by cards and other opaque substances.

“These observations serve to explain part of the evidence given before the ‘Royal Commission appointed in 1857 to report upon the site best adapted for the National Gallery,

in reference to the facts stated by directors of galleries, artists and picture dealers, as to the injury which pictures suffer by being kept in ill-ventilated and badly lighted places, and of the beneficial effects resulting, in many instances, from the exposure to direct sunlight of injured pictures.

"From this report I quote the following: Mr. Knight, the Secretary of the Royal Academy, stated that he preferred pictures to be exposed to the light if he wanted to preserve the lights of a picture. Mr. Farrer mentioned a case where, by exposing a picture that had been kept in the dark, the blue became brighter. Sir Charles Eastlake, P.R.A., instanced the case of some of the pictures from the late Mr. Turner's gallery, those of 'the Deluge' and 'Queen Mab' in particular, where the whites were turned into blacks, and stated that white lead, if not tolerably well secured from the effects of the atmosphere, would undergo a rapid change in London, and that it was a very general opinion that pictures look better and last longer in the country than in London. Mr. Bentley, who restored these pictures by a secret and chemical process, said that the highest light was perfectly black and that, in fact, 'high light' was 'high dark.'

"I have here an illustration to show that the changes effected by the secret and chemical process may be brought about by simple exposure of the picture to the light. The picture was placed in an atmosphere of sulphide of hydrogen gas until it had acquired a dark brown color. Strips of paper were then fastened across parts of the surface, and it was placed in a window facing the light. Those portions not obscured, it will be observed, have resumed their original appearance, while those covered by the paper remain as black as when the paper was first placed over them.

"Mr. Cooke, R.A., stated that light is one of the greatest agents in the preservation of pictures; that it helps to develop them in every way, particularly with regard to the varnish, and he gave an instance of a picture of his own which he had lent for exhibition to a gallery where it had been exposed to a very strong light; that five months afterwards,

when it was returned to him, he was surprised at its extremely bright appearance.

"In reference to the action of light on varnish mentioned by Mr. Cooke, I may observe that I have found that when light is excluded from a painted white surface, the surface assumes a dingy yellow color, but that the original color is restored by admitting the light to it. This fact is, I find from the report, acknowledged by many artists.

"I have said that the glass cases containing woolen fabrics were blackened, and it may be well to draw attention again to the fact, with a view of showing that no small source of sulphur vapor in the atmosphere of a gallery frequented as the galleries in London are, may arise from the clothes of the visitors."

"That the experiments which I have described, taken in conjunction with the testimony just read, have an important bearing upon the preservation of paintings, will, I think, be evident, as they demonstrate the protecting influence of light upon white lead and those colors with which it is mixed, where the atmosphere is or may become contaminated with sulphurous gases, and conversely the deterioration that paintings must suffer where under the same circumstances the light admitted is feeble—facts deserving of attention in the construction of galleries in the metropolis and large manufacturing towns, and by those who have the care of paintings in churches and public buildings, or who possess collections of their own, and adopt the practice of covering their pictures.

"It is curious to observe in many parts of London the discoloration of houses painted with white lead. I have frequently seen the lower portions completely coated with a metallic-like surface of the sulphide, and I have little doubt that the formation of this compound will be found to be more frequent in winter than in summer time, and more prevalent on the shady than on the sunny side of a street."

The secret chemical process referred to by Price undoubtedly consisted in the use of an oxidizing agent. Hydrogen peroxide is the substance usually recommended for this

purpose; but there is no reason why we should be limited to this oxidizing agent and, as a matter of fact, any oxidizing agent may do more harm than good<sup>1</sup> in certain cases.

"Where sulphur fumes have decomposed the lead color and formed a brownish result, chemists have recommended the use of peroxide of hydrogen, and while this may be theoretically the proper method to pursue, it is not necessary, and sometimes dangerous, for the reason that even though peroxide of hydrogen will bring back flake white and chrome yellow to their original color, it may bleach an adjacent lake beyond redemption; and as these sulphur decompositions of color are usually on the surface, the wood alcohol and turpentine treatment with very slight abrasion, will produce all the results necessary. The cleaning and renovation of pictures in the hands of an intelligent person is not a very difficult problem, but it is very easy to spoil any good painting by the use of nostrums and recipes which are destructive in their effect."

"A 'secret chemical process' which works well in some cases is to take soap and water, and to wash off the extremely thin film of discolored pigment. The simplest way to prevent the formation of lead sulphide is not to use a color containing lead. On the painter's palette, flake white has been practically superseded by Chinese white; but the less dangerous lemon yellow is still used.

"The effects due to harmful gases in the air and to a varying dewpoint can be minimized by keeping paintings carefully varnished and by painting the back of the canvas.<sup>2</sup> If the pigments are not washed carefully when they are prepared, substances may be left in which will have a deleterious effect either on that pigment or on some other pigment with which it may later be mixed. This is responsible for some of the contradictory reports in regard to the permanency of certain colors. Aurelian and cadmium yellow are typical cases.<sup>3</sup>

<sup>1</sup> Toch: *Materials for Permanent Painting*, 61 (1911).

<sup>2</sup> Toch: *Ibid.*, 182 (1911).

<sup>3</sup> Toch: *Ibid.*, 90, 102 (1911).



"Aurelian is a pigment that has been introduced during the last generation, and is sometimes sold under the name of cobalt yellow. It is a double nitrite of cobalt and potassium. There is a variety of opinion as to its permanency. Some claim that it is absolutely permanent both in water and in oil, and others claim that it decomposes with a white, but from the experiments made by the author its permanence depends entirely upon its purity. If the color is thoroughly washed by the manufacturer after it is precipitated in order to free it from soluble salts, it may be regarded as absolutely permanent, because it is not affected by sulphur gases nor by sunlight. If the color is impure, it is very likely to decompose any lake which may be added to it, and when mixed with new linseed oil, it loses its brilliancy in a short time. There are several good manufacturers of this pigment, whose aurelian yellow may be used and regarded as absolutely permanent."

"Cadmium yellow may fail, and in many instances does fail, because it is improperly made and because it is ground in an emulsion of oil and water, or because the oil in which it is ground may be of a highly acid nature. Manufacturers of tube colors ought to learn the lesson that no tube color should be ground in a chemically bleached vegetable oil, for oils are principally bleached by means of a strong acid like sulphuric or chromic, and all traces of these acids are not entirely washed out, so that much trouble may arise from the ultimate effect of this trace of acid, and even a good color like cadmium may be decomposed if the oil be not entirely pure."

We can now consider some possible methods of cutting down the action of light on pigments. While all rays which are absorbed tend to decompose a pigment, the absorbed rays are not equally effective. In the bromination of organic compounds, the most effective rays are those corresponding to the weaker bromine absorption bands in the yellow-green and orange, instead of those corresponding to the stronger absorption bands in the greenish-blue and blue.<sup>1</sup> If we should

---

<sup>1</sup> Schramm and Zakrzewski: Monatsheft, 8, 299 (1897).



cover a pigment with some substance which would cut off the more effective rays, we should increase the permanency of that pigment to light very much. Though we have no quantitative spectroscopic study of this point, this case appears to occur with vermilion and madder.<sup>1</sup>

"Vermilion is a sulphide of mercury, and is artificially made by mixing sulphur and mercury in the presence of an alkaline solution under heat and pressure. It ranges in shade from a light orange to a deep scarlet, and while it is perfectly true that when used alone as an oil color and exposed to the brilliant sun rays, it will darken considerably, when glazed over with madder, as is frequently done after it is thoroughly dry, it is remarkably permanent, or when properly varnished it is very stable."

The varnish on a picture cuts off the ultra-violet light to a very great extent and protects the picture in this way, in addition to keeping out moisture and the gases in the air.

The yellowing of pictures is due to a change in the oil.<sup>2</sup> "That the cause is what may be termed the effect of light on a mixture of white lead, zinc oxide and linseed oil, or a linseed oil varnish is evident because paint chemists have long known that white lead in any form, whether it be called flake white, cremnitz white, silver white or white lead, has a reducing action on the pigment present in linseed oil, or linseed oil varnish, and that this reducing action changes this pigment into another pigment which is yellow. It may fairly be asked whether such a reaction can take place if the linseed oil is bleached. To this question the reply must be given that the bleaching of linseed oil does not destroy the color which is present, but simply changes it from an olive yellow to an exceedingly pale yellow, which can hardly be seen, so if we take refined or bleached linseed oil and mix it with white lead or zinc oxide, we have a very brilliant white which remains white as long as it is exposed to bright light. If we

<sup>1</sup> Toch: *Materials for Permanent Paintings*, 108 (1911).

<sup>2</sup> Toch: *Ibid.*, 33, 35, 38 (1911).

L  
A  
V  
V  
X  
A  
O  
C  
a

1  
r

take this mixture and place it for six weeks in an absolutely dark place, the white paint changes into the well-known yellow tint and it is this particular change which produces in all paintings the distinct yellowness of age."

"Another line of experiments was carried out, in which bleached linseed oil was also used. This turned exceedingly yellow in three months, but when exposed for three months to the bright sunlight it became brilliant white again, and upon being placed in a dark closet for another three months no change took place. Those parts of the painted experiment which had been bleached by the sunlight remained white in the dark closet at the end of the experiment. This would, therefore, prove that when a picture has turned yellow it can safely be exposed to the sunlight in order to bring back its natural brilliancy, provided, of course, that no part of it has been painted with asphaltum or bitumen, for the asphaltum and bitumen, instead of bleaching in the light, become black."

"If linseed oil is insisted upon by the painter the raw, unbleached, unrefined product should be used, for it is reasonable to assume that it cannot grow any darker as long as the coloring matter is not visibly hidden, but may improve, for upon exposure the color will surely bleach, and upon replacing the painting in a poorly lighted room it will not grow any darker than it originally was when the painter used it."

These experiments raise the question whether a better way of bleaching might not be found which would destroy permanently the coloring matter in the oil.

Since the action of light on pigments is an oxidizing one in the majority of cases, the safest pigments to use are normally those which are made by oxidation and this is a point to be kept in mind when studying coal tar colors. While it is possible that the organic chemist may some day give us a series of colors which are absolutely permanent to light, it will perhaps also be well to consider whether we cannot increase the stability of all or some of the colors that we now have. The coal tar colors are used as pigments chiefly in the form of lakes. In spite of the importance of the matter

we seem to have no definite, quantitative information as to the actual effect due to mordant or to base. In books on dyeing one finds isolated statements that such and such a dye is faster with one particular mordant than with another; but there are no general statements and no attempt at an explanation or theory.

We have found that some lake pigments are more fast to light than the corresponding dye is when dissolved in water; but there is no reason to suppose that this is generally true. Playfair<sup>1</sup> has shown that calcined alumina causes nitric acid to attack indigo. "A portion of alumina may be taken and placed at the bottom of a vessel containing warm  $\text{NO}_3[\text{HNO}_3]$ ; no action ensues, except partial solution; a strip of calico colored in indigo-blue may now be introduced into the mixture, and remains unaffected in the clear acid, but is immediately discharged when pressed with a glass rod into the alumina. Here the alumina acts by placing the oxygen of the nitric acid in a state of tension without however succeeding in decomposing it, but the moment an assistant affinity comes into play, that state is shown by the decomposition of the nitric acid and the oxidation of the indigo. The alumina in the presence of the acid could not oxidize (in fact we know of no higher oxide), and therefore the indigo appropriates the oxygen. I find that various other oxides, such as calcined  $\text{Cr}_2\text{O}_3$  and  $\text{SnO}_2$  have the same power, the latter showing this disposition more than any of the other oxides."

Of course this experiment of Playfair's does not bear directly on the matter in which we are interested; but it is very suggestive and has an important indirect bearing. In a recent book<sup>2</sup> there is a statement that copper salts are known to increase the stability of all dyes to light. In view of the fact that copper salts act as oxygen carriers, I doubt the accuracy of this statement. It is important either way. If copper salts really do increase the stability of all dyes to light, we must get a theory to account for the fact. If they do not

<sup>1</sup> Jour. Chem. Soc., 3, 354 (1847).

<sup>2</sup> Limmer: Das Ausbleichverfahren, 43 (1911).

act in this way, the statement serves to illustrate our general ignorance in regard to the subject.

The whole question of double mordants or of fixing agents is also an important one. When we wish fastness to washing we know that we must add lime when we mordant alizarine with alumina. Methylene blue stands soaping if fixed by magnesium and aluminum acetates.<sup>1</sup> Orange No. 2 is fixed by chromium and magnesium acetates; chromium acetate, *per se*, gives a brown color; magnesium acetate *per se* does not fix the color. Grey coupler and induline require chromium or the latter mixed with magnesium acetate.

Of course, fastness to soaping is not the same thing as fastness to light; but the facts are suggestive and open up an unexplored field. Indigo is considered by the dyers as one of the most permanent dyes, while the painters consider it as fugitive.<sup>2</sup> "This transparent blue is unfortunately, gradually oxidized and browned when exposed to light. In thin washes of water-color it disappears rapidly in the sun's rays, much more slowly when submitted to diffused daylight. The following figures approximately represent the reduction in force of a sample of indigo as a moist water-color when exposed to sunlight:

Original intensity.....	10
After two years.....	1
After ten years.....	0

Other trials with other samples gave in some cases less unfavorable results. Indigo in cake is sometimes less affected by sunlight than the moist preparations. As an oil-color, indigo loses from one-third to one-half its intensity when exposed to sunlight for five years, its hue being at the same time altered, in different specimens, either to a greyish or a greenish blue; the change is more conspicuous when the indigo has been mixed in tint with flake or other white. Locked

<sup>1</sup> Koechlichen: Jour. Chem. Soc., 44, 893 (1883).

<sup>2</sup> Church: The Chemistry of Paints and Painting, third edition, 219 (1901).

up in copal or amber varnish it is more slowly changed. The fading is due to oxidation."

Part of the difference in opinion between dyers and painters is probably due to differences in methods of testing; but I have a suspicion that oriental rugs owe part of their fastness to light to the fact that the weavers did not use chemically pure mordants.

If one wishes to study this subject experimentally, it is desirable to have a method by which tests can be made in a relatively short time. By using different concentrations of peroxides or persulphates we can get oxidizing agents of different strengths in neutral, acid or alkaline solutions. By comparison with dyes which are known to be fast to light we can lay down the arbitrary rule that a pigment is fast to light if there is no appreciable change in a given time in a given solution at a given temperature. Our experiments are only preliminary ones; but the method seems a promising one. There is one interesting thing to be noted. While we should expect to get the same bleaching by light and by the oxidizing agent, the rate of bleaching in the light varies with the relative intensity of the absorbed light and the rates for any two lights are not necessarily equal when the relative intensities of the lights are those necessary to make white light as we see it. As a matter of fact, we found that Victoria green bleached more rapidly than eosine or methylene blue in a hydrogen peroxide solution, while the reverse is the case in sunlight.

There is another point about which we have no theory at present, and that is as to the variation in stability with the method of preparation. Church<sup>1</sup> says that "vermilion prepared from the mineral or native cinnabar is probably less liable to change than the artificial products, whether obtained by the dry way or moist way; but 'moist way' vermilions are certainly the most alterable." The artificial ultramarine is more readily attacked by acids<sup>2</sup> and by alum than is lapis

<sup>1</sup> "The Chemistry of Paints and Painting," third edition, 168 (1901).

<sup>2</sup> Toch: Materials for Permanent Painting, 163 (1911).

lazuli. So far as two samples of vermilion are mercuric sulphide they should behave alike. The difference must therefore be due either to agglomeration or to the presence of adsorbed impurities. In either case it is a problem in colloid chemistry. Our general ignorance in regard to a lot of these things is illustrated by the fact that nobody knows whether lemon chrome and sublimed white lead are or are not definite compounds.

The general results of this paper:

1. Light may change pigments in all sorts of ways; but the change of color is usually due to an oxidation.
2. A drier in the oil may cause reduction of a pigment, the oil being oxidized; or it may accelerate the oxidation of the pigment.
3. Lead sulphide is oxidized to sulphate by light, and pictures which have blackened in the air can therefore be improved by an exposure to bright sunlight.
4. Colors which are really permanent may seem fugitive if prepared improperly or if ground in oil that has been bleached with acid
5. Madder probably protects vermilion by cutting off the rays which are most active in producing the allotropic change.
6. Varnishes keep out moisture air, and ultra-violet light.
7. Pigments produced by oxidation are more likely to be stable than those produced by reduction.
8. By changing the nature of the precipitating agent it ought to be possible to vary the fastness of lakes to light.
9. From the analogy with dyeing, it seems probable that the maximum fastness to light can be obtained when lakes are made with a suitable mixture of precipitating agents.
10. It is doubtful whether copper salts increase the fastness of all dyes to light.
11. Rapid tests for fastness to light can be made with solutions of peroxides or of persulphates.
12. The relation between the stability of vermilion, etc., and the methods of preparation is a problem in colloid chemistry.

*Cornell University*

## RAPID TESTING OF DYES AND PIGMENTS<sup>1</sup>

BY GEORGE E. GRANT AND ARTHUR S. ELSENBAST

The actual testing of dyes and pigments in regard to their relative permanency to light is slow work. Of course the time can be cut down somewhat by using a very intense source of light; but this is permissible only in case one is certain that the amount of change is proportional to the product of the intensity of light into the time of exposure. There is ~~no certainty that that is true in any particular case even~~ when using monochromatic light and it certainly is not the case with an arc light. In fact the whole nature of the reaction may change. Methylene blue may be oxidized or reduced. In the immediate neighborhood of a quartz, mercury vapor, lamp, there is enough ozone formed to bleach colors which would ordinarily be perfectly stable.

Since most colors are bleached by oxidation, it seemed that it ought to be possible to prepare solutions of oxidizing agents of varying strengths such that one could say that a given dye or pigment was practically fast to light in case it did not bleach perceptibly in a given solution within a given time. Our experiments are only preliminary ones; but they indicate the possibility of working out a satisfactory method along these lines.

Experiments were first made with methylene blue, methyl violet, Victoria green, magenta, azo red, and eosine, using hydrogen peroxide as oxidizing agent. The concentration of the dyes was 0.1 gram per liter. In the first series, 0, 2, 4, 8, 10 cc of a three percent solution of hydrogen peroxide were added respectively to bottles each containing 10 cc of the dye solution. The thirty-six bottles were shaken and then put away in the dark. They were examined every day for about four weeks. The following results were obtained at the end of twenty-seven days.

---

<sup>1</sup> A paper read before the Eighth International Congress of Applied Chemistry in New York, September, 1912.

**Methylene Blue**

All bottles containing hydrogen peroxide have faded as compared with the standard; not very much difference owing to concentration of hydrogen peroxide, though the shade gets a little lighter as the concentration increases.

**Methyl Violet**

The bottles containing 2 and 4 cc hydrogen peroxide solution are much lighter than the standard; but the two are apparently exactly alike. With increasing concentration of  $H_2O_2$ , the color decreases rapidly, the 10 cc bottle being practically colorless.

**Victoria Green**

The bottle with 2 cc  $H_2O_2$  solution shows a slight tinge of green; the other bottles are quite colorless. The dye is much more fugitive to hydrogen peroxide than methylene blue or methyl violet.

**Magenta**

The 8 cc and 10 cc bottles are entirely faded; the others have a slight color, the 2 cc bottle having a little the most color.

**Azo Red**

There is a slight pink tinge in the bottle containing 2 cc  $H_2O_2$ ; but the others are almost colorless.

**Eosine**

Not much change in the 2, 4 and 6 cc bottles. The other two are almost colorless.

The objection to these tests is that the concentration of the dye varies in the ratio of one to two, and this might be considered as objectionable. In order to eliminate this, a series of experiments was made in which 1 cc of the dye solution (0.1 gram per liter) was taken in every case. We added 50 cc, 35 cc, and 25 cc of the three per cent solution of hydrogen peroxide to different bottles and diluted all solutions to 51 cc. The solutions were examined at the end of 16, 41, and 65 hours; in other words, on each of the next three days.



#### **Methylene Blue**

After 16 hours no very great change as compared with the standard, though the 50 cc and 35 cc bottles are a bit faded, the shade being greenish rather than bluish. After 41 hours all three solutions are distinctly faded, the change being more marked with the 35 cc and 50 cc bottle than with the 25 cc one. After 65 hours the results are about the same as after 41 hours.

#### **Methyl Violet**

After 16 hours all three solutions have faded considerably, and there is a regular gradation, the solution containing the most  $H_2O_2$  having faded the most. After 41 hours the 50 cc bottle is entirely colorless; the 35 cc bottle has a very slight tinge of color and the 25 cc bottle a slight tinge. After 65 hours all three solutions are almost entirely faded.

#### **Victoria Green**

After 16 hours the 50 cc bottle has only a very slight greenish tinge. The other two bottles have apparently faded about equally but not quite so much as the 50 cc bottle. After 41 hours the color is entirely gone in all three bottles.

#### **Magenta**

After 16 hours the 50 cc bottle shows almost no color; the 35 cc bottle shows a little more color; and the 25 cc bottle is distinctly colored, though very much faded as compared with the standard. After 41 hours there is no color in any of the bottles.

#### **Azo Red**

After 16 hours all three bottles are distinctly faded; but the differences among themselves are less than the difference between them and the standard. After 41 hours the three bottles have about the same tint. Though very much faded, there is still color. After 65 hours there is still a trace of color in all three bottles.

#### **Eosine**

After 16 hours all three bottles have a distinctly yellow

color than the standard. The 50 cc and the 35 cc bottles have faded about equally and quite a bit more than the 25 cc bottle. After 41 hours the 50 cc and the 35 cc bottles are almost entirely faded and the 25 cc bottle is pretty far gone. After 65 hours the 50 cc and the 35 cc bottles are entirely faded and there is only a slight color in the 25 cc bottle.

These experiments show that it is possible to distinguish quite sharply between these dyes. Methylene blue is distinctly the most stable to hydrogen peroxide; next comes azo red; and then come methyl violet and eosine; while Victoria green and magenta are the most fugitive under these circumstances. As has been stated, these experiments are only preliminary ones and will have to be extended so as to cover some of the more stable dyes. As far as they go, they are distinctly encouraging.

The difference in the dyes can be shown in another way, the results being a first approximation only and varying of course with the temperature. Starting with 1 cc dye solution (0.1 gram per liter) and 50 cc three percent hydrogen peroxide solution, the time necessary for fading was 20 hours for magenta (completely faded); 23 hours for Victoria green (completely faded); 48 hours for eosine (almost entirely faded); 65 hours for methyl violet (almost entirely faded); 65 hours for methyl violet (almost entirely faded); 95 hours for azo red (completely faded); while methylene blue was still standing up at the end of 200 hours.

Experiments were next tried with some lake colors presented to us very kindly by Messrs. Toch Brothers, of New York. The names and descriptions of these colors were as follows:

*Eosine Vermilion.*—An eosine precipitated with lead acetate on red lead (orange mineral).

*Scarlet Lake.*—2 R Scarlet fastened with barium chloride on barium sulphate and alumina hydrate.

*Ian Red.*—An azo cerise on blanc fixe.

*Red Lake, No. 625.*—An azo red on barium sulphate and clay.

*Eosine Lake, No. 1812.*—Eosine fastened with lead acetate on alumina hydrate and barium sulphate.

*Magenta Lake, No. 678.*—Magenta on alumina hydrate.

*Blue Mauve, No. 676.*—Methylene violet on alumina hydrate.

*Green Lake Deep.*—Victoria green and methylene blue on clay.

*Green Lake Yellow.*—Victoria green and auramine on clay.

In these experiments we weighed out 0.05 gram of the pigment, added it to 60 cc  $H_2O_2$ , shook for two minutes in a mechanical shaker, and then put the bottle away in the dark for six days. The solutions were filtered, the pigments dried and compared with the original color. In some of the cases the lakes had bled considerably.

#### **Eosine Vermilion**

Bleeds slightly more than eosine lake and fades more. The standard is much darker than the sample which has been treated with hydrogen peroxide.

#### **Scarlet Lake**

Bleeds more noticeably. After treatment with hydrogen peroxide the color changes from scarlet to orange red.

#### **Ian Red**

Bleeds very badly and fades very much, turning to a pale pink color.

#### **Red Lake**

Bleeds much and turns to a pale orange color.

#### **Eosine Lake**

Bleeds slightly; but not so much as eosine vermilion. Fades a good deal, the color becoming more of an orange.

#### **Magenta Lake**

Bleeds scarcely at all but fades almost completely, though there is a faint color left.

**Blue Mauve**

Not much bleeding. Fades considerably, changing from a dark purple color to a light pale lavender.

**Green Lakes**

Practically no bleeding. Fade very much, turning to a grayish green color.

Since it was possible that the change of color was due in large part to the bleeding and not to the bleaching, the preceding experiments were repeated, substituting 60 cc H<sub>2</sub>O for 60 cc H<sub>2</sub>O<sub>2</sub> solution. Though all the lakes, except the greens, bled noticeably, the colors of the filtered and dried lakes were practically those of the original samples, showing that very little actual color had been washed out and that hydrogen peroxide did actually cause the lakes to fade. It is to be noticed that these lake colors resist the action of hydrogen peroxide very much better than did the corresponding dyes.

Some experiments on the dyes previously studied showed that potassium persulphate acted more rapidly than hydrogen peroxide of the concentration we were using. Experiments were also made with a number of other dyes. The solutions were made up to contain 0.03 gram dye, 7 grams K<sub>2</sub>S<sub>2</sub>O<sub>8</sub> and 80 cc H<sub>2</sub>O. The approximate times for practically complete fading were 16 hours for naphthalene red; 19 hours for rosazarine; 23 hours for neutral violet extra; 25 hours for naphthalene yellow; 36 hours for Rose Bengale; 58 hours for azo acid violet 4 R; 60 hours for Victoria violet; 60 hours for cotton orange; 238 hours for diamine fast yellow; and 250 hours for dianine gold.

One run was made with the lakes at 60°–75°, the solution consisting of 0.03 gram pigment, 7 grams K<sub>2</sub>S<sub>2</sub>O<sub>8</sub>, and 80 cc H<sub>2</sub>O as before. The approximate times for complete fading were about 10 hours for blue mauve; 15 hours for eosine vermilion and red lake; 48 hours for scarlet lake; 53 hours for eosine lake; 90 hours for green lake deep; while Ian red did not become entirely colorless in 150 hours. These results

are not entirely in accord with those obtained with hydrogen peroxide at ordinary temperature. It is an open question whether the time necessary for complete bleaching is a satisfactory criterion in the case of the lakes. Most of the lakes bleach very much in the first hour or so and then change very slowly. Probably a measure of the percentage change in a moderately short time would be more satisfactory.

Experiments were next made as to the bleaching action of sunlight on dyes in solution, using the same six dyes which were tested with hydrogen peroxide. To 10 cc. of the dye solution (0.1 gram per liter) there were added 40 cc.  $H_2O_2$ . Owing to the unsettled weather, no absolute measure of the time of fading could be obtained; but eosine bleached the most rapidly and then methylene blue. In course of time the methylene violet, magenta, Victoria green and azo red solutions all bleached to colorless liquids. This is in keeping with the experiments showing that all these dyes bleach in presence of hydrogen peroxide. There is a discrepancy, in that eosine and methylene blue are the first to fade in the sunlight, whereas methylene blue is the last to fade in hydrogen peroxide. This is a bit puzzling; but, after all, it is really no more surprising than that one reaction should go faster than another in one solvent and slower in another. Both are beyond us for the present. The practical bearing of it is that we may use the hydrogen peroxide test, within certain limits, to show stability of a given dye to light; but we must not use it to measure relative rates of fading on exposure to light. It is not necessarily light of the same wave-length which acts on any two of the dyes and the results will therefore vary among themselves with the varying nature of the source of light. Thus, eosine fades relatively faster than methylene blue when exposed to the light of a quartz, mercury vapor, lamp and both gain relatively to the other four dyes under these circumstances. When using the standard solution of 0.05 gram per liter, the time for practically complete fading is about 5 hours for eosine; 8 hours for methylene blue; 15 hours for methylene violet; 20 hours for azo red and for magenta; while Victoria green

takes about 24 hours to bleach. On standing in the dark the color comes back with the methylene blue and to some extent with the others.

Experiments were next made with 0.03 gram of each lake suspended in 80 cc water. The mixtures were exposed to sunlight for seven weeks and were examined daily. Only about 13 or 14 days out of the lot were really bright days. The eosine faded first, and then the eosine vermilion which did not go completely. The scarlet lake was next to go and then came blue mauve and magenta lake, none of these three becoming entirely colorless. The red lake faded slightly while the greens were not changed much and the Ian red showed no change of color that we could detect.

The dry, powdered, lakes were exposed to sunlight, such as it was, for about six weeks. During this time the eosine was the only one to fade noticeably.

Reference has been made to the possible desirability of determining the percentage bleaching at the end of the given time instead of noting the time necessary for complete fading. The relative results will not be the same by the two methods unless the time-color curves are of the same general shape. While we have no quantitative data on this point, we made a few qualitative experiments along this line with hydrogen peroxide as oxidizing agent. Methylene blue and azo red fade gradually, the azo red fading faster than the methylene blue. Methyl violet and eosine fade very little at first, standing up almost as well as methylene blue; then they suddenly fade very fast. Magenta and Victoria green fade very fast at first and then very gradually. For short intervals of time, methyl violet and eosine are apparently more stable than azo red, while the reverse is true for longer intervals.

The general results of this paper are:

1. Methylene blue, methyl violet, Victoria green, magenta, azo red and eosine are bleached at ordinary temperature by a suitable concentration of hydrogen peroxide. It is easy to arrange the experiment so as to bring out marked differences in the relative stability of these dyes.

2. Methylene blue and azo red fade gradually; methyl violet and eosine fade slowly at first and then quite rapidly; magenta and Victoria green fade fast at first and then gradually.

3. Taking practically complete bleaching as the end point, the order of stability is methylene blue, azo red, methyl violet, eosine, Victoria green and magenta, this last being the most fugitive. For shorter intervals of time the order may be methylene blue, methyl violet, eosine, azo red, Victoria green, and magenta.

4. A similar bleaching effect can be obtained with persulphate solutions.

5. Solutions of all six dyes bleach in the sunlight and also in the light of the quartz, mercury vapor, lamp. The order of stability is not the same as in the oxidizing solutions, being Victoria green, magenta and azo red, methyl violet, methylene blue, and eosine, the last being the most fugitive. This discrepancy is due in part to the fact that the oxidation of the dyes is not always due to light of the same wavelength.

6. We have studied the action of hydrogen peroxide and of sunlight on the following lake colors: eosine, vermilion, scarlet lake, Ian red, red lake, eosine lake, magenta lake, blue mauve, green lake deep, green lake yellowish.

7. All the lakes except the greens bled badly and all were bleached very much by hydrogen peroxide. They are very much more stable to hydrogen peroxide and to sunlight than the corresponding dyes.

8. The dry lakes were not much affected by six weeks exposure to occasional sunlight, the eosine fading much the most.

9. When suspended in water the lakes are bleached by sunlight, the order of permanency under the conditions of the experiment being Ian red, the greens, red lake, magenta lake and blue mauve, scarlet lake, eosine vermilion, and eosine lake, the last being the most fugitive.

10. These preliminary results indicate the possibility of working out rapid qualitative tests as to the stability of dyes and pigments in sunlight. Such tests are absolutely necessary for any systematic study of the factors affecting stability.

This investigation was suggested by Professor Bancroft and has been carried out under his direction.

*Cornell University*



## THE PHOTOCHEMICAL OXIDATION OF BENZENE<sup>1</sup>

BY WILDER D. BANCROFT

In a paper published over thirty years ago, Leeds<sup>2</sup> showed that oxalic acid is formed and no phenol when benzene and moist phosphorus are allowed to stand in a warm place exposed to diffused light. If placed in full sunlight, considerable quantities of phenol are also formed. Ozone oxidizes benzene to oxalic acid, acetic acid, formic acid, and carbon dioxide. Hydrogen peroxide oxidizes benzene to a mixture of oxalic acid and phenol, the relative amounts of phenol not being given. What really happens in Leeds' experiment is that moist phosphorus and air give rise to ozone in diffused light and to hydrogen peroxide in bright sunlight. He recognized this himself but he offered no explanation for the difference.

That the sunlight should have an effect is not surprising; but the problem is to determine why we should get hydrogen peroxide in the bright light and ozone in the diffused light. There is a rather remarkable paragraph in a paper by Wurster.<sup>3</sup>

"Oxygen is made active and is converted in large amounts into the permanently active forms of ozone and hydrogen peroxide only, when the rays of the sun fall upon oxygen and water simultaneously, as was first shown by Schönbein, though the fact was made use of for thousands of years in bleaching. Under these conditions of intimate contact of oxygen with drops of water the oxygen is readily made active by light and the oxygen molecule is disrupted at ordinary temperature in a way which is otherwise obtained only at a very high temperature or under the action of a very intense lime light or electric light. The oxygen is split into atoms which react to form ozone and hydrogen peroxide. This is not so remarkable

<sup>1</sup> A paper read before the Eighth International Congress of Applied Chemistry in New York, September, 1912.

<sup>2</sup> Ber. chem. Ges. Berlin, 14, 975 (1881).

<sup>3</sup> Ibid., 19, 3212 (1886).

when we recall that, according to Graham, we must consider dissolved gases or gases condensed on surfaces as being in the liquid state. They have therefore lost, as heat, the energy corresponding to the change to the liquid state; but, on the other hand, the readiness of the molecules to react is presumably increased by their being nearer together."

This would be admirable if Wurster had differentiated between the formation of ozone and of hydrogen peroxide, instead of lumping the two together. The action of ordinary sunlight on a mixture of oxygen and water really forms hydrogen peroxide instead of ozone.

Wilson<sup>1</sup> has postulated the formation of hydrogen peroxide when ultra-violet light acts on moist oxygen. I quote from J. J. Thomson.<sup>2</sup> "Wilson showed that the passage of ultra-violet light through a gas (as distinct from the effects produced when it is incident on a metal surface) produces very interesting effects on the condensation of clouds. If the intensity of the light is small then no clouds are produced unless the action equals that (1.25) required to produce clouds in gases exposed to Röntgen rays. If, however, the ultra-violet light is very intense, clouds are produced in air or in pure oxygen, but not in hydrogen, by very much smaller expansions, and the expansion required decreases as the time of exposure to the light increases; thus the nuclei producing the clouds grow under the influence of the light. If the light is exceedingly strong, clouds are produced in air or oxygen without any expansion at all. Wilson was even able to produce these clouds in air standing over a seventeen percent solution of caustic potash, and which therefore was not saturated with water vapor; in this case the drops lasted for three hours after the light was cut off; this, as Wilson points out, shows that the drops cannot be pure water. These clouds are probably analogous to those observed years ago by Tyndall,<sup>3</sup> when ultra-violet light passes through air contain-

<sup>1</sup> Phil. Trans., 192, 403 (1899).

<sup>2</sup> Conduction of Electricity through Gases, second edition, 169 (1906).

<sup>3</sup> Phil. Trans., 106, 333 (1870).

ing the vapors of certain substances of which amyl nitrite was the one which gave the most striking effects. The effects can be explained by the formation under the influence of the ultra-violet light of some substance—Wilson suggests that in his experiments it was  $H_2O_2$ —which, by dissolving in the drops as they form, lowers the equilibrium vapor pressure, and thus enables the drops to grow under circumstances which would make drops of pure water evaporate. This explanation is supported by the fact that ultra-violet light does not produce these clouds in water vapor by itself or in hydrogen; and also by the fact that, unlike the clouds due to Röntgen rays, these clouds formed by ultra-violet light do not diminish in density when a strong electric field is applied to the gas, showing that the nuclei are either not charged or that if they are charged they are loaded with foreign molecules so that they do not move perceptibly in the electric field. Vincent<sup>1</sup> has observed movements of these drops in a strong electric field; he found that some drops moved in one direction, others in the opposite direction, while there were some which did not move at all. Thus some drops are uncharged, others positively or negatively charged. It would thus seem that the charges have nothing to do with the formation of these drops, the drops merely forming a home for the ions produced by the ultra-violet light.”

While these experiments make it probable that hydrogen peroxide is formed by the action of ultra-violet light or moist air, there is no direct proof of the presence of hydrogen peroxide and Vincent was not able to detect it. This gap has been filled by the experiments of Fischer and Ringe,<sup>2</sup> who have shown that the silent discharge in an ozonizer produces hydrogen peroxide instead of ozone when the air is nearly saturated with water vapor. The failure to obtain ozone under these conditions is not surprising because it is a well-recognized fact in the commercial manufacture of ozone that

<sup>1</sup> Proc. Camb. Phil. Soc., 12, 305 (1904).

<sup>2</sup> Ber. chem. Ges. Berlin, 41, 951 (1908).

the yield falls off unless the air is kept moderately dry. More recently Makowetsky<sup>1</sup> has shown that hydrogen peroxide is formed when a direct current glow discharge passes through oxygen or air to a water cathode. This is not an electrolytic phenomenon because the yield at low currents exceeds that called for by Faraday's law. It is just as much a photochemical reaction as is the ozone production. We should therefore expect to find that the action of sunlight on air would produce ozone when the air was moderately dry and when the sunlight was rich in ultra-violet light of wave-lengths less than 300  $\mu\mu$ . We should expect to get hydrogen peroxide in presence of water. The yield of ozone would of course be negligible in case the sunlight contained almost no rays having wave-lengths less than 300  $\mu\mu$ . The experiments of Bacon<sup>2</sup> offer a very satisfactory confirmation of this view. "When pure water or a salt solution is exposed to direct sunlight in Manila, hydrogen peroxide is formed very rapidly, strong tests being obtained after a few hours. H. D. Gibbs, of this Bureau, examined the solutions in a great number of reagent bottles exposed in the laboratory for some months to diffuse light and found considerable quantities of hydrogen peroxide in practically every case. It is evident that in the Tropics, at least in island regions, with the great quantity of vegetable growth, the vigorous transpiration of plants, and the large amounts of water continually present at the surface of the earth and in the air, all the conditions are present when the sun is shining, which are necessary to charge the water surfaces, to form peroxide of hydrogen, and in general to increase the proportion of ions in the air according to the processes which have been outlined above. Whether there is a true ionization of the air by tropical sunlight, apart from such a secondary ionization, must be determined by further studies. Considerable evidence is accumulating to show that the tropical sunlight contains more in-

<sup>1</sup> Zeit. Elektrochemie, 17, 217 (1911).

<sup>2</sup> Philippine Jour. Sci., 5A, 271 (1910).

tense ultra-violet light than that in temperate zones. Thus I have shown in another paper<sup>1</sup> that the decomposition of oxalic acid or of oxalic acid catalyzed by uranium salts is very much more rapid in the Philippines than in temperate zones, and Gibbs<sup>2</sup> has shown that the coloration of phenol and of aniline takes place much more rapidly in the tropics than in more northern zones.

"One of the most striking effects produced by ions is the influence they exert on the condensation of clouds. I have often noted, in watching a steam jet in the open air in Manila, the remarkable way in which, as the sunlight strikes it, it becomes dense and beautifully colored, due to the interference and diffraction of the light by the small drops of water, while as soon as the sun goes behind a cloud, the jet becomes very thin, and the colors, of course, disappear. Other conditions being equal, on a cloudy day the mountains near Manila can be seen much more clearly than on one of sunshine, and I do not believe I err when I state that all days of bright sunshine in the Philippines show a decidedly hazy atmosphere, as noted by looking at objects at some distance. I believe this fact to be due to the ionization of the air by the sunlight and the consequent condensation of very minute drops of water around the ions so formed. The mountains are most clearly visible from Manila at sunrise and at sunset and on days when clouds protect the lower atmosphere from the ionizing radiations of the sun."

It does not seem very probable that the hydrogen peroxide in the reagent bottles in Manila could come from ionized air which got in when the bottles were opened. If this is not the case, then oxygen and water must react to form hydrogen peroxide to some extent under the influence of light which can pass through glass.

The matter of the ionization of the air in Manila has been discussed by Freer.<sup>3</sup> "Another phenomenon to be ob-

<sup>1</sup> Philippine Jour. Sci., 5A, 281 (1910).

<sup>2</sup> Ibid., 3A, 361 (1909); 4A, 133; 5A, 9,419 (1910).

<sup>3</sup> Philippine Jour. Sci., 5B, 10 (1910).

served in Manila in a marked degree, and which, so far as I am aware, has not been recorded in the literature from other climates, is the extensive ionization of the air when exposed to the sunlight. Doctor Bacon, using a modern electroscope, has been able to show that our atmosphere, when exposed to the direct rays of the sun, rapidly discharges the instrument, the loss of potential being 46 volts per hour, whereas, in the diffused light of a room it is only 15, and during the night 6, for the same volume of air. This is certainly a remarkable result, which deserves further study. The only comparative data on hand are a few by Elster and Geitel<sup>1</sup> giving us an indication of what the fall of voltage would be in northern climates. They found, in Vienna on a foggy day, a voltage of 2.77, in clear weather, 8.58, but on a day when the sky was half overcast, 13.67. These authors ascribe the phenomenon to radio-activity, but our results in Manila, where radio-active phenomena are not especially prominent, would lead to the conclusion that the air is ionized by sunlight. The presence of this ionization in so great a degree in our atmosphere would indicate a condition of the solar spectrum which might well account for many of the so-called excessive effects which have been observed."

Experiments were made in Manila to determine the extent of the solar spectrum at the ultra-violet end.<sup>2</sup> The spectra were obtained at noon. "They probably do not extend beyond  $\lambda = 291 \mu\mu$ , and therefore not much farther than has been observed by others. Measurements undertaken by Miethe and Lehmann<sup>3</sup> in Assuan, Berlin, Zermatt, Gornegrat, and Monte Rosa give practically identical numbers, namely  $291.55 \mu\mu$  to  $291.21 \mu\mu$  during the latter part of August and the first part of September, these authors finding, in contradistinction to Cornu,<sup>4</sup> that altitude above the sea

<sup>1</sup> Drude's Ann., 2, 425 (1900). The authors used an instrument of identical form with our own.

<sup>2</sup> Freer: Philippine Jour. Sci., 5B, 14 (1910).

<sup>3</sup> Sitzungsber. Akad. Wiss. Berlin, 8, 268 (1909).

<sup>4</sup> Comptes rendus, 88, 1107; 89, 808 (1879).

level makes no great difference. As one of these places is at  $24^{\circ} 30'$  north latitude, while the others are in northern climates, it is evident that, as the extent of the ultra-violet field does not change materially, the intensity factor in the solar spectrum must vary to a great extent in different places. However, it is possible that a considerable range of ultra-violet is absent at present (March 1) from our sunlight. Probably this area will increase as the angle of the sun diminishes and as the season advances, and it may reach a maximum in April, although these recent results would seem to indicate that even here we will not get below  $288 \mu\mu$ .

These observations are important because they show that, under ordinary conditions, the sunlight reaching the earth contains practically none of the rays which cause the formation of ozone, the rays of wave-lengths less than  $300 \mu\mu$ , while it does contain ultra-violet of wave-lengths greater than  $300 \mu\mu$ , the rays which cause the decomposition of ozone. The bearing of this on our problem is easily shown. When phosphorus is oxidized, there is normally a production of ozone. In presence of benzene, we get the oxidation products characteristic of ozone—oxalic acid, etc., but no phenol. In bright sunlight, the ultra-violet light actually present checks the formation of ozone by making it less stable. We consequently get a certain amount of hydrogen peroxide formed. The data are not sufficient to show whether the yield of ozone drops to zero. That would depend to some extent on the intensity of the sunlight. In presence of benzene we get the decomposition products characteristic of hydrogen peroxide or of a mixture of hydrogen peroxide and ozone, namely a mixture of phenol and oxalic acid.

It is not surprising that we should also get phenol when benzene, water and palladium hydrogen are shaken up with air,<sup>1</sup> because hydrogen peroxide is known to be a reduction product of oxygen.

The general results of this paper are :

<sup>1</sup> Hoppe-Seyler: Ber. chem. Ges. Berlin, 12, 1551 (1879).

1. When benzene is oxidized by ozone, the chief product is oxalic acid, while a mixture of oxalic acid and phenol is obtained when benzene is oxidized by hydrogen peroxide.

2. When moist phosphorus oxidizes in presence of benzene, the chief oxidation product of the benzene is oxalic acid if the reaction takes place in the dark or in diffused light. A mixture of oxalic acid and phenol is obtained if the reaction takes place in bright sunlight.

3. Hydrogen peroxide is formed by the action of the silent discharge, or of bright sunlight, upon a mixture of water and air.

4. At the surface of the earth bright sunlight rarely contains any appreciable amount of ultra-violet light having wave-lengths less than  $290 \mu\mu$ .

5. At the surface of the earth bright sunlight tends to destroy ozone and not to form it.

6. When moist phosphorus oxidizes in bright sunlight, the yield of ozone is decreased and that of hydrogen peroxide is increased.

*Cornell University*



ON THE NATURE OF THE CHEMICAL ACTION PRODUCED BY  $\alpha$  PARTICLES AND THE PROBABLE ROLE PLAYED BY IONS .

BY S. C. LIND

1. Introduction

During the rapid extension of radioactive investigation in various directions, no part of the field seems to have been more neglected than that of the chemical action produced by radioactive agencies. Perhaps a dozen papers would include all the quantitative data on this subject and few general principles have as yet been established. This criticism might apply with almost equal truth to the extent of our knowledge regarding the manner in which any other form of radiant energy is transformed into chemical action. The chief obstacle to progress lies in the difficulty of ascertaining the mode in which radiant energy is absorbed or expended in a given system. However, the absorption of the energy emitted by radium has been found for gases to be very closely related to the *ionization* produced, an effect that can be exactly measured; and, although the problems arising in this connection are not as yet wholly solved, it is not too much to claim that we have more definite information in regard to the mode of absorption of radioactive rays in a gaseous system, than we possess for any other form of radiant energy.

From the work of Prof. Bragg<sup>1</sup> and others, quite accurate data for the ionization of a number of different gases by  $\alpha$  particles are available, and if one could establish a relationship between the extent of ionization and the amount of chemical transformation brought about, one would have taken an essential step in determining the nature of the chemical actions produced by the  $\alpha$  particles. As far as the author is aware, he was the first to suggest, and to find quantitative evidence to support, the idea that a close relation exists be-

<sup>1</sup> Bragg, Phil. Mag., [6] 11, 617 (1906); 13, 333 (1907).

tween ionization of a gas and the chemical action produced in it under radioactive influence. This discovery came as a result of the study of the amount of ozone produced in oxygen by the  $\alpha$  particles projected into the gas through a very thin glass bulb,<sup>1</sup> where it was found that the total number of molecules of ozone formed in a given time is very nearly equal to the calculated number of ions produced during the same time. The most plausible assumption seemed to be that one pair of ions is involved in the production of each molecule of ozone.

After having found this close relation between the ionization of oxygen and its ozonization, it became a question of particular interest to see whether similar relations exist for other gas reactions taking place under the influence of the  $\alpha$  particles. It has been found by an examination of the available experimental data on chemical effects under radioactive influences, which include experiments of Cameron and Ramsay, Debierne, Usher, and of the author, embracing a fairly large variety of reactions, differing very widely from each other in their chemical nature, that all correspond to a surprising degree with the principle found for ozone, namely, equivalence between ionization and chemical action. The list of reactions that have been studied include reactions of combination and of decomposition; reactions proceeding with, as well as opposed to, the chemical free energy; even reactions in liquid systems and solutions obey the same principle. In fact, not a serious exception has been met with among reactions produced by  $\alpha$  particles. It is with the quantitative relation, then, between the calculated ionization in different systems, and the observed chemical effects under radioactive influence, that the present paper deals.

An unavoidably large amount of experimental details and calculations are involved and, therefore, it may not be out of place to give in advance a brief outline of the main themes and the method of treatment.

<sup>1</sup> Lind: *Monatshefte*, 32, 295-310 (1912); *Am. Chem. Jour.*, 47, 397 (1912); *Le Radium*, 9, 104 (1912).

The main object of the present paper is to show that in all the reactions that have been investigated, the amount of chemical action produced by the  $\alpha$  particles is directly related to the number of ions formed, no matter what the nature of the liquid or gaseous system being acted on. The ratio of ions to molecules reacting  $\left(\frac{N}{M}\right)$  is usually very close to unity, and never too far off to be brought into agreement by making some suitable assumption regarding the mechanism of the reaction. In general, it has not been attempted to settle upon any definite mechanism for a given reaction, since the available data are not of such a character as would enable one to decide between the numerous possibilities that present themselves for consideration, and we content ourselves with the statement that the order of magnitude of the electrical and the chemical quantities is the same. This alone represents a material advance, for usually, one would be at a loss in predicting the amount of chemical effect in a reaction brought about through the agency of any other form of radiant energy.

The calculation of the total number of molecules of gas ( $M$ ) taking part in a reaction may be made directly either from the data of chemical analysis or of manometric measurement. On the other hand, the calculation of the ionization ( $N$ ) produced in a gas by a radioactive source is frequently complicated by a large number of influencing factors with which it is difficult to deal quantitatively. This cannot be better illustrated than by the action of radium emanation on some gas with which it is mixed in a small volume. Most of the radioactive chemical effects have been examined under exactly these conditions. The total number of ions produced by a known quantity of emanation in a given time will depend on the nature of the gas, its pressure, its volume, and even on the shape of the containing vessel, which determines the length of path that the  $\alpha$  particles may have. In Sec. 2 a method is proposed for the estimation of the "average path" of  $\alpha$  particles in small volumes, either spherical or

cylindrical, which enables one to estimate the total number of ions (N). It is through the employment of this conception of "average path" as a means of calculating ionization that a larger quantity of data has become available for the purposes of the present investigation. These data and the method of their treatment are discussed in Sec. 3, and are presented in Sec. 4, together with all the derived values necessary for the calculation of N and M. In Sec. 5 the data and methods of calculation for *liquid* systems are presented. In Sec. 6 is a table summarizing all the values of the N/M ratio and a discussion of their significance. In Sec. 7 a kinetic equation is developed for gas reactions taking place under influence of radium emanation, which is applied to a number of reactions in Table III. In Sec. 8 the results and conclusions of some other authors are discussed, and in Sec. 9 the general conclusions, as far as it appears possible to draw any, are presented.

## 2. The Average Path of $\alpha$ Particles in Confined Volumes, and the Calculation of Ionization

In the experiments of the author (*loc. cit.*) on the formation of ozone by  $\alpha$  particles, the total ionization, too great to be measured directly on account of the difficulty of obtaining saturation current, was calculated by means of the ionization curve of Bragg,<sup>1</sup> from the "free range" of the  $\alpha$  particles outside the bulb containing the emanation, with application of the necessary corrections. No other data of this nature were available. In all other gas reactions that had been studied, emanation had been mixed directly with the gases in small volume. It was not at once clear how to proceed to calculate the ionization in these cases, but it becomes possible on making certain assumptions which will now be considered.

It has been shown<sup>2</sup> very conclusively by Rutherford and

<sup>1</sup> *Traité de Radioactivité*, II, p. 168. Bragg and Kleeman: *Phil. Mag.*, [6] 10, 318 (1905).

<sup>2</sup> Rutherford and Geiger: *Phil. Mag.*, [6] 240, 698 (1910).

Geiger that the probability variations in the distribution of  $\alpha$  particles obeys the law of chance, and hence the radiation, if extended over fairly long periods, may be regarded as evenly distributed in all directions. The problem of calculating the ionization in small confined volumes containing emanation, resolves itself, then, into one of finding the "average path" of all the  $\alpha$  particles in such a volume. The average path for emanation would be defined as the average of all the straight lines that can be drawn from any point *within the volume in any direction until they meet the surface*; the average path for particles of Radium A and Radium C would be defined as the average of the straight lines that can be drawn from any point *on the inner surface in any direction until they again meet the surface*, assuming that Radium A is deposited evenly on the surface of the containing vessel shortly after its formation, and that Radium C is similarly situated.

Let us then proceed first to find an expression for the "average path" in a *sphere*. The accompanying diagram (Fig. 1) may be taken to represent a great circle of a sphere,

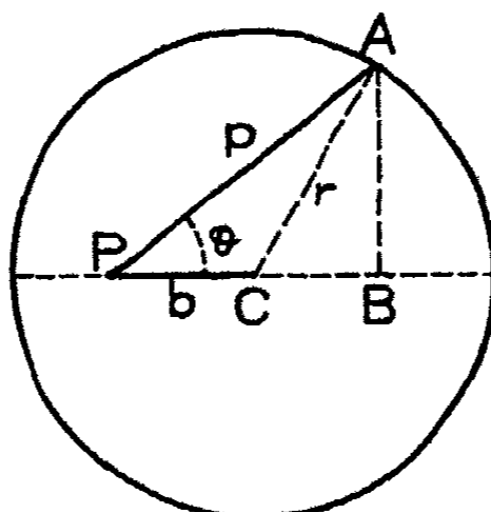

-Fig. 1-

in which an  $\alpha$  particle starting from any point P, at any distance  $b$  from the center C, travels the path  $p$  in reaching any point A on the surface. The radius of the circle (or sphere) is  $r$ , and the angle which the path makes with the diameter through P is  $\theta$ .

$$p^2 - 2bp \cos \theta + b^2 = r^2$$

$$p = b \cos \theta \pm \sqrt{r^2 - b^2 + b^2 \cos^2 \theta} = b \cos \theta \pm \sqrt{r^2 - b^2 \sin^2 \theta}$$

$$\begin{aligned} p(\text{Av.}) &= \frac{1}{\pi} \int_0^\pi (b \cos \theta + r \sqrt{1 - \left(\frac{b}{r}\right)^2 \sin^2 \theta}) d\theta \\ &= \frac{r}{\pi} \int_0^\pi \sqrt{1 - \left(\frac{b}{r}\right)^2 \sin^2 \theta} d\theta = \frac{1}{\pi} r \cdot 2E\left(\frac{\pi}{2}, \frac{b}{r}\right) \end{aligned}$$

This expression may be used to calculate the average path assuming any definite value for  $b$ , and, since a plane can always be passed through any path and the center of the sphere, the relation which we have found for the great circle must also hold for the sphere. In order to obtain a fair approximation to the average value of the path ( $p$ ) for all distances from the center ( $b$ ), ten values of  $b$  have been chosen which represent radii of the concentric spheres that would divide the whole into ten equal volumes. These values of  $b$  and the corresponding values of  $p$  are given in the following table:

TABLE I  
 $r = 1$

$b$	E. (elliptic integral)	$p$
0.456	1.482	0.944
0.585	1.427	0.908
0.664	1.379	0.878
0.737	1.328	0.846
0.794	1.282	0.816
0.844	1.235	0.786
0.888	1.186	0.755
0.928	1.136	0.723
0.965	1.076	0.685
1.000	1.000	0.637
		Mean, 0.798

Assuming then that Radium A and C are wholly on the inner surface of the spherical vessel, one obtains the average path for all  $\alpha$  particles by giving double weight to the value  $p = 0.637$  and taking the average with  $0.798$ , which represents the average path of  $\alpha$  particles from gaseous emanation. The mean value thus obtained is  $0.691$ , and we may define the average path in a sphere for  $\alpha$  particles from radium emanation in equilibrium with Radium A and C as follows:  $\text{av. path} = 0.691, r = 0.427, V^{1/3}$ , where  $r$  is the radius and  $V$  the volume of the containing sphere. Evidently this will not apply to a sphere having a diameter greater than the range of the slowest  $\alpha$  particles in the gas in question, because some of them in that case would not reach the wall at all; moreover, in the practical calculation of ionization by means of the average path, a further restriction as to volume must also be made, which will be discussed shortly.

In the gas reactions which have been actually studied under the influence of emanation, however, the containing vessels were not spherical, but generally *cylindrical*, and the relations for the average path in the whole volume become very complicated to treat either graphically or mathematically, but since most interest attaches to the *average path for points on the surface*, round end cylinders of various dimensions were examined graphically by sections, and not only a surprising but gratifying result was obtained. For three cylinders of lengths two, four, and eight times the respective diameters, it was found by the graphical treatment that the average path from points on the surface in all directions, is the same numerical fraction of the radius of a sphere equal in volume to the cylinder, as was found for the sphere itself, namely  $0.637 r$ . This very simple relation between average path and volume was, as far as the author has been able to ascertain, hitherto unknown, and he is unable to predict to what other kinds of volumes it would be applicable, if to any. If it is absolutely applicable to cylinders of any length, the mathematical demonstration of which has not been attempted, it is not impossible that it may also apply to all volumes of revo-

lution and, perhaps, to all volumes in which a straight line may be drawn from any point on the surface to any other point without being intercepted, that is, volumes with convex surfaces.

Since the average path from points on the surface of cylinders is equal to  $0.637 r$ , just as in the sphere, it does not seem improbable that the average path for *all* of the  $a$  particles, including those having their origin within the gas volume, should be the same fraction of  $r$  as in the case of a sphere. This is, of course, a conjecture, and one that we have not even attempted to demonstrate graphically, but it cannot be far from correct, if not exactly so, because the source of two-thirds of the activity with which we are dealing *is in all cases on the surface*; for which we have seen that the relation does hold; and, as regards the remaining one-third of gaseous activity, its three dimensional distribution requires that most of it be much nearer the surface than the center. In view of these considerations, it has been thought justifiable to use the same expression for average path of all  $a$  particles for cylinders (and even for volumes which in some cases depart somewhat from cylindrical shape) as was found for the sphere; namely, average path ( $p$ ) =  $0.427 \cdot V^{1/3}$ .

From a knowledge of the average path of the  $a$  particles, the ionization per second may then be calculated from the following well-known relation:

$$\frac{dN}{dt} = 3 \times 3.4 \cdot 10^{10} \cdot E_t \cdot 2.2 \cdot 10^4 \cdot p \cdot i \cdot P/760 \dots \dots (1)$$

in which  $3 \times 3.4 \cdot 10^{10}$  is the total number of  $a$  particles emitted per second by 1 Curie of emanation in equilibrium;  $E_t$  is the quantity of emanation in equilibrium at time  $t$ ;  $2.2 \cdot 10^4$  is the number of ions formed per centimeter by each  $a$  particle along the first two or three centimeters of the path in air at atmospheric pressure;  $p$  is the average path as defined above;  $i$  is the specific ionization which we define as the ionization per cm for any gas compared with that of air



under the same conditions;  $P/760$  is the correction for pressure;  $N$  is the number of ions.

Since the ionization per centimeter of path remains approximately constant for only the first three centimeters for Ra C and less for Ra A and emanation, it is evident that a further restriction must be placed on the volume in calculating the ionization by the formula given above. Its use should give good results in a volume where the maximum path does not exceed one or two centimeters, and can be used with a fair degree of approximation up to three centimeters. In all experiments where these conditions are not satisfied, attention will be directed to it.

In the earlier part of this paper we shall be more concerned with the total number of ions formed in a given system during an interval of time  $t$ , which can be a little more conveniently obtained from the following formula than from (1), though the principle is identical. The number of atoms of emanation in equilibrium with 1 gram of radium is  $3.4 \cdot 10^{10}$ .  $\theta^1 = 1.64 \cdot 10^{16}$ , and since each atom of emanation emits three  $\alpha$  particles in disintegrating, the total number of  $\alpha$  particles emitted during the time  $t$  may be found from the equation:

$$\text{Total } \alpha = 4.92 \cdot 10^{16} \cdot E_0 \cdot (1 - e^{-t/\theta});$$

and, as in (1), we obtain the total ions by the formula:

$$\begin{aligned} N &= \text{total } \alpha \cdot 2 \cdot 2 \cdot 10^4 \cdot \text{path} \cdot i \cdot P/760 \\ &= 1.08 \cdot 10^{21} \cdot E_0 (1 - e^{-t/\theta}) \cdot \text{path} \cdot i \cdot \frac{P}{760} \dots \dots \dots (2) \end{aligned}$$

<sup>1</sup>  $\theta$  is the mean life = 5.55 days.

\*In a previous paper (Loc. cit.) the author employed the following expression for the average quantity of emanation ( $E$ ) remaining through an interval of time  $t_0 - t$ :  $\log E = \frac{\log E_0 + \log E_t}{2}$ , which is mathematically incorrect, but fortunately the time interval employed was so short that no serious error resulted and the values may stand as first calculated. The correct expression is  $E = \frac{E_0 - E_t}{\lambda t}$ , but it has been found more convenient to reckon ionization through the emanation decaying during a given interval, as illustrated above, instead of using the average of the emanation remaining.

### 3. A General Consideration of the Experimental Material and the Methods of Treatment

Both gaseous and liquid systems will be treated in the present paper, and since the considerations involved in the calculation of the amount of ionization in the two are quite different, they will be dealt with separately. Much of the available data regarding the chemical action of the  $\alpha$  particles on gases is comprised in the work carried out in the laboratory of Sir William Ramsay, which has been published in a paper by Cameron and Ramsay<sup>1</sup> and a later one by F. L. Usher.<sup>2</sup> The former includes a study of the syntheses of water and of ammonia from their elements, as well as the decompositions of CO, CO<sub>2</sub>, HCl, and NH<sub>3</sub>; the paper by Usher is a more extended study of the equilibrium between NH<sub>3</sub> and its elements. These reactions all proceed with a change of volume or can be made to do so by employment of a suitable reagent as absorbent. The gases, mixed with emanation, were confined in small volumes (usually 1–3 cm<sup>3</sup>) over mercury, and the course of the reaction was followed manometrically. The employment of the small volumes necessary for manometric measurement results in a reduction of the efficiency of the emanation by shortening the paths of the  $\alpha$  particles, but one must admit that it is the only practicable method for making a series of observations on such small effects, and for the purpose of the present paper the small volumes have an additional advantage in simplifying the method of estimating the total ionization, as has already been pointed out. Although the conclusions reached by Cameron and Ramsay in regard to the nature of the chemical action of emanation on gases differ very materially from those set forth in this paper, yet it is largely through the aid of their very careful measurements that it has been possible to extend to a much broader field the same principle found in the ozonization of oxygen; and the close agreement with the provisions of the theory herein suggested, appear to justify its further extension.

<sup>1</sup> Cameron and Ramsay: Jour. Chem. Soc., 93 I, 966 (1908).

<sup>2</sup> F. L. Usher: Jour. Chem. Soc., 97 I, 389 (1910).

The only other data suitable for testing this principle for gas reactions are two experiments of the author: the first,<sup>1</sup> on the combination of hydrogen and bromine when mixed with emanation, was included among some other experiments on chemical effects which were carried out in the laboratory of Mme. Curie about a year ago, and the second, on the polymerization of oxygen to form ozone, was made shortly afterwards in the Institut für Radiumforschung in Vienna.<sup>2</sup> Both of these reactions were allowed to take place at constant pressure and the products were measured by means of chemical titration methods which rendered the determination of the small quantities involved, fairly accurate.

In all the experiments of the author the quantity of emanation present was determined by the  $\gamma$  ray method after introduction into the vessel in which it was to be used. Except in the experiments on ozonization, the measurements were based on the radium standard of Mme. Curie; in the former case they were based on the Vienna standard and a correction of 15 percent was applied to bring them into agreement with the standard of Rutherford on which the value of  $3.4 \cdot 10^{10}$   $\alpha$  particles per second is based. The unit of quantity of emanation employed exclusively in this paper is the Curie; it was necessary to divide those of Cameron and Ramsay by two, in order to convert them into this unit. The quantities of emanation of Cameron and Ramsay were not measured *in loco*, but they assumed that the theoretical quantity of emanation, as calculated from the time of accumulation, was that actually employed; nor do they state to what standard their quantity of radium in solution was referred. The measurements of Debierne were based on the standard of Mme. Curie.

It may also be well to define here exactly the present use of the term *specific ionization*, which I follow Bragg<sup>3</sup> in using, in the sense, however, of the *molecular*, and not the

---

<sup>1</sup> Lind: *Le Radium*, 8, 289 (1911).

<sup>2</sup> *Loc. cit.*

<sup>3</sup> Bragg: *Loc. cit.*

*total specific ionization.* This requires a fuller explanation. Proceeding from the generalization that the ionization curves of different gases differ from each other only in a shortening or lengthening of all the ordinates and abscissae by the same ratio, Bragg made the following very useful simplification. Instead of having to determine the complete curve of ionization for each gas it is only necessary to find the ionization,  $I$ , at one particular point,  $R$ , in the path of the  $\alpha$  particles; if  $I'$  and  $R'$  are the corresponding values for air under the same conditions, the ratio of the total ionizations in the two media may then be expressed by:  $\frac{RI}{R'I'} = \frac{k}{k'} (1)$ ; and putting  $k' = 1$ , the total specific ionization is referred to air. But if we wish to refer, not to the total ionization, but to that produced in a certain part of the path, we must use the ratio  $\frac{I}{I'}$ , which we can show to be equal to Bragg's  $ks$ , as follows: Putting the reciprocal of the ranges  $R$  and  $R'$  equal to  $s$  and  $s'$ , the respective "stopping powers," as they have been called by Bragg, and substituting in (1), we may write:  $\frac{I}{I'} = \frac{ks}{k's'} = ks$ , putting  $k's'$  for air equal to unity. This value,  $ks$ , may be called the *molecular specific ionization* to distinguish it from the *total specific ionization* ( $k$ ). Since the number of molecules in different gases is the same in equal volumes, and hence, also, between the same electrodes in all gases, it is evidently to this molecular specific ionization of Bragg ( $ks$ ) that we refer in defining our specific ionization ( $i$ ) as the ratio of the specific ionization per centimeter along the initial part of the path of the  $\alpha$  particles in any gas, referred to the ionization per centimeter in air at the same temperature and pressure, over the same part of the path. For  $i$  we shall then use Bragg's  $ks$  values for various gases as follows:  $H_2 = 0.24$ ;  $O_2 = 1.15$ ;  $N_2 = 0.94$ ;  $CO_2 = 1.59$ . For the other gases with which we have had to deal, Bragg has reported no values, and they had to be estimated comparatively by methods that will be taken up in detail as the cases arise. For mix-

tures of two different gases  $i$  has been estimated by the simple law of mixtures.

The following notation will be employed:  $V$  is the actual volume of the reaction tube containing the gases, which is usually reported by the authors, and may be readily calculated, when not given, from the pressure and the N. T. P. gas volume, which latter we designate as  $v$ ;  $t$  is the duration of time in days;  $E_0$  is the initial quantity of emanation in Curies;  $P$  is the arithmetic mean of the initial and final pressures in mm of mercury, which has been used as the *effective pressure* during the interval  $t$  in calculating the ionization (cf. Sec. 4); this use of  $P$  (mean) instead of an integral average is not strictly correct, but introduces no grave error as will be shown in Sec. 7;  $v_0 - v$  is the change of volume (N. T. P.), given directly by the authors, and from which  $M$ , the number of molecules is calculated on the basis of  $2.69 \cdot 10^{19}$  per  $1 \text{ cm}^3$ , by taking into account the volume change as indicated by the reaction formulae;  $i$  is the specific ionization as defined above. In the formulae for the chemical reactions all substances not in the gaseous state are enclosed in parentheses. In reaction 1 the calculation is carried out in full, and later notes are added as needed. The data used in Sec. 4 were chosen at random, one value only being taken from each series. Later, in Table III, Sec. 7, a kinetic equation will be applied to the whole of several series which shows that any other value might be chosen equally well. The experiment numbers and the pages refer to the original articles already cited, and some abbreviation has been employed for authors' names.

Finally, it should be stated that although every attempt has been made to make these estimations as trustworthy as possible, it is nevertheless realized that the employment of simplifying assumptions which are not always strictly fulfilled, as well as the necessity of using data sometimes not wholly suited for the purpose, may have led in a few cases to the introduction of rather large errors. But it is believed that they nowhere become so serious as to influence the orders of magnitude nor any of the conclusions that have been drawn.

It is principally for this reason that no attempt is made, at present, to propose exact mechanisms for any of the reactions that are treated, but the attention is directed to the striking agreement of  $N$  the number of ions with  $M$ , the number of molecules entering into action.

#### 4. Reactions in Gaseous Systems

Reaction 1.— $2\text{H}_2 + \text{O}_2 = (2\text{H}_2\text{O})$ .

The specific ionization  $i$  has been calculated on the assumption of a composition corresponding to the electrolytic mixture, which gives  $\frac{2 \times 0.24 + 1.15}{3} = 0.54$ . The mixture of  $\text{H}_2$  and  $\text{O}_2$  obtained by sparking the gases coming off with emanation from the radium solution, contained some excess of hydrogen, but judging from the composition found in the cases where analysis of the products was carried out, the excess was not sufficient to affect the value of  $i$  appreciably, therefore the value 0.54 has been employed throughout this reaction, except in one case (*d*).

*a.* ("Expt. 4" of Cameron and Ramsay, p. 974.) (Moist gases, not analyzed.)

$V$  (actual volume) = 2.186 cm<sup>3</sup>;  $t$  = 4.13 days;  $E_0$  = 0.0465 Curies;  $i$  = 0.54;

$v_0 - v$  (volume change, N. T. P.) = 1.505 - 1.106 = 0.399 cm<sup>3</sup>;

$P$  (mean pressure) =  $\frac{523.5 + 384.5}{2} = 454.0$  mm;

$p$  (av. path) =  $0.427V^{1/3} = 0.554$  cm;

$N = 4.92 \cdot 10^{18} \times E_0(1 - e^{-it}) \times 2.2 \cdot 10^4 \times p \cdot i \cdot P/760 = 4.72 \cdot 10^{18}$  (total ions);

$M_{\text{O}_2} = 0.399 \times 2.69 \cdot 10^{18} = 3.6 \cdot 10^{18}$  ( $\text{O}_2$  molecules reacting);

$N/M_{\text{O}_2} = 1.33$ .

*b.* (C. and R. "Expt. 5," p. 975.) (Moist gases, analyzed.)

$V = 2.79$ ;  $t = 4.8$ ;  $E_0 = 0.0125$ ;  $v_0 - v = 0.122$ ;  $i = 0.54$ ;

$P = 547.8$ ;  $p = 0.601$ ;  $N = 1.84 \cdot 10^{18}$ ;  $M_{\text{O}_2} = 1.1 \cdot 10^{18}$ ;

$N/M_{\text{O}_2} = 1.66$ .

*c.* (C. and R. "Expt. 6," p. 977.) (Dry gases, analyzed.)

$V = 4.996$ ;  $t = 3.8$ ;  $E_0 = 0.022$ ;  $v_0 - v = 0.276$ ;  $i = 0.54$ ;

$P = 556.6$ ;  $p = 0.730$ ;  $N = 4.32 \cdot 10^{18}$ ;  $M_{\text{O}_2} = 2.5 \cdot 10^{18}$ ;

$N/M_{\text{O}_2} = 1.73$ .

NOTE.—The introduction of  $P_2O_5$  into the tubes as drying agent would be expected to break up the free paths of the  $\alpha$  particles. The fact that no difference is observed between the results for moist and dry gases could be accounted for if the  $P_2O_5$  became somewhat "moistened down" onto the glass walls, as is frequently the case in its use, and thus minimized the disturbance of the free paths. Even though this partial moistening takes place, the drying effect is hardly, if at all, diminished, and the question which has been raised by H. B. Baker<sup>1</sup> as to whether radiation can produce chemical action in dry gases seems to be answered in the affirmative.

d. (C. and R. "Expt. 7," p. 977.) (Dry gases analyzed, cf. below.)

$$V = 3.43; t = 5.81; E_o = 0.0515; v_o - v = 0.321; i = 0.625;$$

$$P = 308.0; p = 0.644; N = 6.0 \cdot 10^{18}; M_{O_2} = 2.9 \cdot 10^{18};$$

$$N/M_{O_2} = 2.07.$$

NOTE.—In this experiment excess of oxygen was introduced and the increased value of  $i = 0.625$  was calculated from the analysis.

e. (C. and R. "Expt. 8," p. 978.) (Dry gases 99 percent pure, not analyzed.)

$$V = 1.566; t = 1.93; E_o = 0.0315; v_o - v = 0.147; i = 0.54;$$

$$P = 433.5; p = 0.496; N = 1.53 \cdot 10^{18}; M_{O_2} = 1.32 \cdot 10^{18};$$

$$N/M_{O_2} = 1.16.$$

f. (C. and R. "Expt. at 130°, p. 989.") (Pure electrolytic gases.)

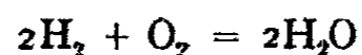

$$V = 0.1197; t = 5.73 \text{ hours}; E_o = 0.1315; v_o - v = 0.0038;$$

$$i = 0.54;$$

$$P = 540; p = 0.210; N = 7.5 \cdot 10^{16}; M_{O_2} = 11.0 \cdot 10^{16};$$

$$N/M_{O_2} = 0.68.$$

This reaction was carried out in a tube of very small volume at a temperature of 130°. In a similar experiment with steam it was shown that the reverse reaction is negligible. The whole experiment extended over only 5.73 hours

<sup>1</sup> H. B. Baker: Chem. News, 103, 173 (1911).

after the introduction of emanation, and the method of calculating the number of  $\alpha$  particles and the consequent ionization differs radically from that employed in the previous experiments, because it must be taken into account that during the first three hours after introducing the emanation, the quantities of Ra A and Ra C are increasing. This reaction will be again referred to in a later section, but it may be noted that, although the amount of reaction produced per unit of emanation decaying is several fold smaller than in the preceding reactions, as was observed by Cameron and Ramsay (p. 990), yet when compared with the number of ions formed, the abnormality appears much smaller and is in the sense of greater activity instead of less; in other words, the smaller amount of action per quantity of emanation should be expected from the shortening of the paths of the  $\alpha$  particles in the very small tube employed, and temperature alone, probably has a small accelerating influence (cf. Sec. 8).

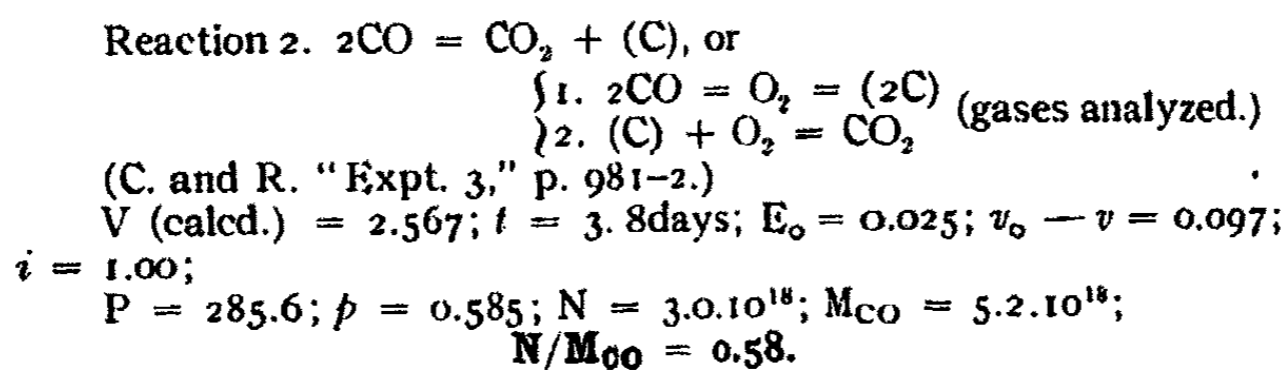

NOTE.—The value of  $i = 1.00$  has been chosen as approximately correct from the following considerations: (1) By inspection of Bragg's<sup>1</sup> values for  $ks$  it will be seen that in the majority of cases they do not depart materially from the density ratio of the gas in question, compared with air and accordingly we should calculate for CO the value 0.97. (2) Although Bragg has pointed out that  $ks$  is not strictly an additive property in the same sense that the stopping power ( $s$ ) itself is, nevertheless for many gases  $ks$  is also approximately additive, because  $s$  is the larger of the two terms, and so, by

<sup>1</sup> Loc. cit.



using the value of  $ks$  for  $\text{CO}_2$ , 1.59; and  $ks$  for  $\frac{1}{2}\text{O}_2$ , 0.58, we should predict:  $\text{CO}_2 - \frac{1}{2}\text{O}_2 = \text{CO} = 1.01$ , which is in such good agreement with the value estimated from density that we use the value 1.00 with the certainty that it is not more than a few per cent. off.



(C. and R., p. 984.) (Gases analyzed.)

$$V = 3.151; t = 9.77; E_0 = 0.345; v_0 - v = 0.479; i = 1.28;$$

$$P = 564.0; p = 0.626; N = 1.84 \cdot 10^{19}; M_{\text{HCl}} = 1.29 \cdot 10^{19};$$

$$N/M_{\text{HCl}} = 1.42.$$

NOTE.—The shape of the reaction volume in this case departed quite widely from the general cylindrical form, but the resultant variation in path is perhaps within the other limits of error, because if the path varies as the cube root of the volume, cutting the latter entirely into two equal parts would only shorten the average path by the ratio  $1/\sqrt[3]{2}$  or about 20 percent, and the actual change in form of volume was less extreme. Chlorine was absorbed by mercury in this experiment, thus producing the desired change of pressure. We do not understand why the reported total volume does not agree with that calculated from the pressure and the N. T. P. volume, and have preferred to use that calculated from the latter. The value  $i = 1.28$  was chosen from the average of the density value 1.27 and a value (1.29) estimated by the additive method from Bragg's  $ks$  values for  $\text{CCl}_4$ ,  $\text{CHCl}_3$ , and  $\text{C}_2\text{H}_5\text{Cl}$ .

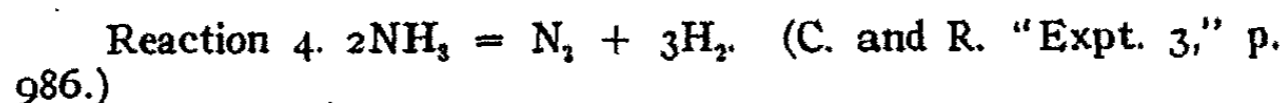

$$V = 1.832; t = 4.9; E_0 = 0.115; v - v_0 = 0.326; i = 0.83;$$

$$P = 874.8; p = 0.531; N = 3.76 \cdot 10^{19}; M_{\text{NH}_3} = 8.8 \cdot 10^{19};$$

$$N/M_{\text{NH}_3} = 4.28.$$

The value  $i = 0.83$  is the direct additive value from  $\text{H}_2$  and  $\text{N}_2$ , and is considerably higher than the density ratio 0.59, but we have regarded the former as being nearer the true value on account of the large percent of hydrogen in the

compound, which has an abnormally high value compared to its low density, as Bragg has pointed out.

Reaction 4A.  $2\text{NH}_3 = \text{N}_2 + 3\text{H}_2$  (Usher, "Expt. III," J. Chem. Soc., 97, p. 394.)

$V = 2.406$ ;  $t = 32$  days ( $=\infty$ );  $E_0 = 0.145$ ;  $v - v_0 = 0.524$ ;  
 $i = 0.83$ ;

$P = 394.2$ ;  $p = 0.572$ ;  $N = 3.87 \cdot 10^{10}$ ;  $M_{\text{NH}_3} = 1.41 \cdot 10^{10}$ ;  
 $N/M_{\text{NH}_3} = 2.74$ .

This value for  $N/M$  shows a somewhat higher efficiency of the emanation than was found by Cameron and Ramsay in this same reaction.

Reaction 5.  $\text{N}_2 + 3\text{H}_2 = (2\text{NH}_3?)$  (Reverse of reaction 4.) (C. and R., p. 988.)

$V = 2.30$ ;  $t = 6.76$ ;  $E_0 = 0.1195$ ;  $v_0 - v = 0.179$ ;  $i = 0.415$ ;

$P = 716.1$ ;  $p = 0.573$ ;  $N = 2.04 \cdot 10^{10}$ ;  $M_{(\text{N}_2 + 3\text{H}_2)} = 4.82 \cdot 10^{10}$ ;  
 $N/M_{(\text{N}_2 + 3\text{H}_2)} = 4.25$ .

The value  $i = 0.415$  is calculated from the values of  $\text{H}_2$  and  $\text{N}_2$  assuming a mixture of the two in stoichiometric proportions; the gases were prepared by sparking  $\text{NH}_3$ , and emanation was added with the excess of  $\text{H}_2$  left after exploding the electrolytic mixture, which excess was doubtless small. The  $\text{NH}_3$  formed by the reaction was absorbed by means of fused  $\text{CaCl}_2$ , thus avoiding the complication of the reverse reaction. The gases were not analyzed in this experiment, and Usher later found that the reduction in volume is apparently not due to formation of  $\text{NH}_3$  (cf. Sec. 7).

Reaction 6.  $2\text{CO}_2 = 2\text{CO} + (\text{O}_2)$ . (C. and R., p. 983.) (Gases analyzed.)

$V$  (calc'd.) = 3.42;  $t = 16$ ;  $E_0 = 0.0625$ ;  $v_0 - v = 0.428$ ;  $i = 1.59$ ;

$P = 411.0$ ;  $N = 3.3 \cdot 10^{10}$ ;  $M_{\text{CO}_2} = 1.15 \cdot 10^{10}$ ;  
 $N/M_{\text{CO}_2} = 2.86$ .

This experiment does not form part of a series and the chemical effect is taken directly from an analysis of the products. Oxygen was absorbed by means of white phosphorus.

Reaction 7.  $\text{H}_2 + \text{Br}_2 = 2\text{HBr}$ . (Lind: Le Radium, 8, 289.)

$V = 25$  cm<sup>3</sup>;  $t = 14$  days;  $\text{HBr}$  formed = 1.6 mg;  $E_0 = 0.025$ ;

$i = 1.35$ ;

$P = 430$  ( $\text{H}_2 = 255 + \text{Br}_2 = 175$ );  $p = 1.27$ ;  $N = 2.4 \cdot 10^{10}$ ;

$M_{(\text{H}_2 + \text{Br}_2)} = M_{\text{HBr}} = 1.2 \cdot 10^{10}$ ;  $N/M_{\text{HBr}} = 2.0$ .

Although the concentrations of both hydrogen and bromine were reported as one-third atmospheric, part of the bromine was liquid at ordinary pressure and we use here its vapor pressure (175 mm) in calculating the ionization, entirely neglecting the liquid which was situated in a narrow capillary, and therefore little exposed to radiation. The value  $i = 1.35$  has been estimated directly by the density method, since no data upon the  $k_s$  value of any bromine compounds have been reported; it is probably too high, as given here, but is compensated in part by the error introduced by using the "average path" method, where some of the paths are much longer than allowable in the strict application of the method of calculation. The dimensions of the reaction tube were about  $10 \times 2$  cm; the value of the average path, 1.27, of course means that only a small fraction of the particles had paths longer than two or three centimeters; so that the total estimation of ions may still be somewhat too large, if the value of  $i$  is much too large for the mixture employed.

Reaction 8.  $3O_2 = 2O_3$ . (Lind, Monatshefte, 32, 295-310 (1912); Am. Chem. Jour., 47, 397 (1912).)

Theoretical value of  $N/M_{O_3} = 2.0$ ; Average value from 8 Expts.  $N/M_{O_3} = 5.1$ .

As stated in the original paper, the rather wide variations in the values of  $N/M$  are difficult to explain in this reaction; but since examining this same relation for so many other gas reactions, and having found the values very uniform from experiment to experiment and even quite uniform from one reaction to another, I am of the opinion that the variations in the ozone results were due to chance losses by reduction before the chemical titration, and that the theoretical value (2.0) could be realized with greater regularity, if this could be avoided.

(For Summary of Results on Gases, see Table II, Sec. 6.)

### 5. Reactions in Liquid Systems

The method of procedure in dealing with the absorption of  $\alpha$  particles in liquids requires some explanation. In the

first place, the much greater density of liquids as compared to gases diminishes the range of  $\alpha$  particles to such an extent that their "paths" may be neglected entirely by assuming complete absorption of all  $\alpha$  particles that are liberated either in the liquid phase or are received from the gas. One has to do, then, with *total* and not with molecular *specific* ionization.

A new question presents itself, however, as to the distribution of emanation between liquid and gas, which involves a knowledge of the volumes of both, as well as the amount of radiation that will be received by the liquid from the emanation and induced activity in the gas phase. Of course, in cases where precautions are taken to avoid the presence of a gas phase, the problem is much simpler. The distribution of emanation between gas phase and water has been recently investigated by Boyle,<sup>1</sup> who finds that emanation obeys Henry's Law and is divided at 14° in the volume ratio of 3 in gas to 1 in water.

With respect to the ionization produced in liquids by  $\alpha$  particles, which has been little investigated directly, the assumption is perhaps justifiable, that the total ionization for a given substance is independent of its state of aggregation as gas or liquid. At least, we know that in gases the total number of ions produced along the entire path of an  $\alpha$  particle is independent of the pressure. Furthermore, the total ionization differs but little for all the different gases that have been measured, which would strengthen the view that it differs but little for liquids. At any rate, the experimental fact remains that the N/M ratio is of the same order as that found for gases, where N is the total number of ions that would be formed by the complete absorption of the rays in the liquid substance, had it existed as gas. And, indeed, this is no more nor less than is claimed for the gas reactions also, because in neither case have we any direct evidence that the *ions* really play a direct part in the chemical action; and it should be borne in mind that the number of ions (N)

---

<sup>1</sup> R. W. Boyle: Phil. Mag., [6] 22, 840 (1911).

is used as a first basis of reference with which the amount of chemical action may be compared. Judging from the data which will be presented later, the comparison is just as well borne out in the case of liquids as of gases, and the possible criticism that the principles of ionization have been somewhat stretched, would seem ill-founded. After all, the whole question may be one, not of ions at all, but of molecular impacts, or more broadly still of the transformation of kinetic into chemical energy.

The following experimental data have been treated: ~~The decomposition of water, (1) by  $\text{RaCl}_2$  dissolved in it~~ (Debierne<sup>1</sup>); (2) by emanation (Cameron and Ramsay<sup>2</sup>), and more recently by F. L. Usher,<sup>3</sup> and the decomposition of anhydrous HBr, and of acid aqueous solution of KI by emanation (Lind<sup>4</sup>). Debierne makes no statement as to gas phase, but in estimating the efficiency to be 1 percent of the total heat effect, he assumes that the whole heat absorption took place in the liquid, and it is provisionally assumed here that he worked in complete absence of gas phase. In the earlier work of Ramsay,<sup>5</sup> the necessity of considering both phases was not recognized, but in his later work (*loc. cit.*) the volume of each is carefully reported, but unfortunately the gas phase is still large in comparison with the liquid phase. This circumstance, together with the unfavorable distribution of emanation, results in drawing by far the greater part of the emanation into the gas, which reduces its efficiency and also renders the estimation of the radiation received by the liquid from the gas phase, a rather rough one, without the exact dimensions of the containing vessel. In one case the estimation could be made with a fair approximation, and agrees, as will be seen later, quite well with the results of Usher and of the author, by both of whom great precautions were taken

<sup>1</sup> Debierne: *Comptes rendus*, 148, 703 (1909).

<sup>2</sup> Cameron and Ramsay: *Loc. cit.*

<sup>3</sup> F. L. Usher: *Jahrbuch d. Radioaktiv. u. Elektronik.*, 8, 323 (1911).

<sup>4</sup> S. C. Lind: *Loc. cit.*

<sup>5</sup> Sir William Ramsay: *Jour. Chem. Soc.*, 91, 931 (1910).

to ensure absence of gas phase; which was, perhaps, perfectly realized by Usher; and within one or two percent for aqueous KI solution, and within 5 percent for liquid HBr, by the author. The fact that Debierne found a lower efficiency will be again referred to. Of course one uses in liquids the total specific ionization  $k$  (cf. Sec. 3) instead of  $ks$ ; and is not at all concerned with paths, since the complete absorption of the  $\alpha$  particle takes place within a small fraction of a millimeter, as has been explained above.

Reaction 9. Decomposition of  $H_2O$  in a solution of  $RaCl_2$ . (Debierne, loc. cit.)

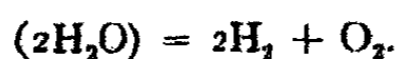

Debierne<sup>1</sup> reports an evolution of 13 cm<sup>3</sup> of hydrogen and oxygen per day per gram of radium from a solution of  $RaCl_2$ , and calculates an efficiency of about 1 percent energy transformation, based on the heat evolution of 118 cal per hour. This efficiency is calculated on the assumption of the full absorption of all four sets of  $\alpha$  particles, therefore we infer that due precautions were taken to ensure the retention of emanation in the gas phase, and calculate as follows:  $N = 3.4 \cdot 10^{10} \times 8.6 \cdot 10^4 \times 7.5 \cdot 10^5 \times 0.82 = 1.8 \cdot 10^{21}$ .  $K$  (total ionization) = 0.82, taken additively from the value 0.24 for  $H_2$  and 0.58 for  $\frac{1}{2}O_2$ .  $M_{H_2O} = 13 \times 2.69 \cdot 10^{19} \times \frac{2}{3} = 1.4 \cdot 10^{20}$ .  $N/M_{H_2O} = 7.5$  (cf. 10A).

Reaction 10. Decomposition of water by Emanation. (Cameron and Ramsay: p. 971.)

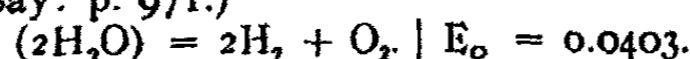

Expt. 1 was carried out in a plain cylindrical tube as shown in Fig. 1a (C. and R., loc. cit., p. 967) and since the volumes 0.291 for the gas and 1.267 for the water phase correspond quite closely with the ones that may be calculated from the actual dimensions in the figure, it is assumed that the latter was drawn approximately to size, or at least that the ratio of length to cross-section was fairly closely represented, which is the only essential in making the following estimation.

<sup>1</sup> Loc. cit.

Taking the distribution coefficient<sup>1</sup> at ordinary temperature equal to 3-1 one can calculate that only 7.1 percent of the total emanation is in the liquid phase; of the remaining 92.9 percent only that part is effective which sends its  $\alpha$  rays toward the water surface, which is only 7.2 percent of the total surface. Therefore, 7.2 percent of 0.929 + 7.1 percent is the total percentage of the effective radiation = 13.8 percent, and therefore the effective ionization in 7.92 days is  $3 \times 1.64 \cdot 10^{16} \times 3.03 \cdot 10^{-2} \times 2 \cdot 10^5 \times 0.82 \times 1.38 \cdot 10^{-1} = 3.37 \cdot 10^{19}$ .  $M_{H_2O} = 2.7 \cdot 10^{19} \times 0.6 \times \frac{2}{3} = 1.94 \cdot 10^{19}$ ;  $N/M_{H_2O} = 3.3$ .

Reaction 10A. Decomposition of water by emanation. (Usher: *Jahrb. d. Radiok. loc. cit.*)

In this experiment the greatest care was taken to avoid the presence of a gas phase, and one may proceed to make the calculations with the assurance that the whole radiation was effective. By the same methods as used in Reaction 9, I have calculated  $N = 3.37 \cdot 10^{20}$  and  $M_{H_2O} = [\frac{2}{3} \text{ (electrolytic gases) + hydrogen}] \times 2.7 \cdot 10^{19} = 1.16 \cdot 10^{20}$ .  $N/M_{H_2O} = 2.9$ .

This value is in quite good agreement with that calculated from Cameron and Ramsay's results and also with those of the author on liquid systems (cf. below) but is quite different from that of Debierne, which must lead to some doubt as to whether the low efficiency observed by Debierne may not have been due to failure to render the gas phase negligibly small.

Reaction 11. Decomposition of liquid anhydrous HBr by emanation. (Lind: *Le Radium, loc. cit.*)

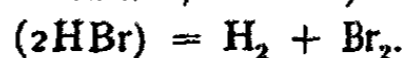

$E_0 = 0.010$ ;  $t = 14$  days; Br liberated = 0.0328 gram;  
 $N = 1.08 \cdot 10^{20}$ ;  $M_{\text{HBr}} = 2.4 \cdot 10^{20}$ ;  $N/M_{\text{HBr}} = 0.45$ .

$N_{\text{HBr}}$  was estimated by multiplying  $N_{\text{air}}$  by 1.25, which was selected by comparison with some of Bragg's other

<sup>1</sup> Boyle: *Phil. Mag.*, [6] 22, 848 (1911).

values, as a probable one for  $k$ . The values of  $k$  for different substances vary only between narrow limits, and there is little error involved in choosing 1.25 as a probable value of  $k$  for HBr. The efficiency of emanation in producing decomposition in this case appears somewhat abnormally high and we have no explanation to offer, unless the heavy glass wall used to contain the compressed HBr, and the fact that the emanation itself was contained in this dense medium, rendered the  $\gamma$  ray measurement too low, which would result in the efficiency appearing too high. Gas phase was negligibly small.

Reaction 12. Decomposition of aqueous acid solution of KI by emanation.

(KI = I + K) or (K + H<sup>+</sup> = K<sup>+</sup> + H). (Lind: Le Radium, loc. cit.)

$E_0 = 0.015$ ;  $t = 6$  days; I liberated = 0.0107 gram;  $N_{(air)} = 9.8 \cdot 10^{19}$ ;

$$M_{KI} = 5.1 \cdot 10^{19}; N/M_{KI} = 1.92.$$

This calculation has been carried out to illustrate the wide applicability of the principle of the equivalence between chemical action and ionization. Since no measurements have been made of the ionization of solutions by radiation, and from their very nature would be difficult to make, it has been assumed that the total ionization would be the same as for air. Of course, it is not to be understood that the entire observed decomposition of KI (or HI) is produced directly; perhaps the larger part is a secondary oxidation following the primary decomposition of water, through the agency of the oxygen liberated, and the whole reaction should, perhaps, not be interpreted as being strictly comparable with the case of pure liquids and gases, but it is interesting to see that the order of magnitude of the effect is the same. The rôle of the free acid is to prevent recombination of the liberated iodine. The actual concentrations were 20 percent KI and 5 percent H<sub>2</sub>SO<sub>4</sub> by weight. A *neutral* 40 percent KI solution liberated, under the same conditions, about one-half of this amount of iodine (0.0057 gram), and a *neutral* 10 percent solution



liberated about  $2\frac{1}{2}$  times less (0.0024 gram) than the 40 percent solution. Further progress in explaining the effect of concentration of the salt must await more complete data, but the author is convinced that little progress will be made by treating the reaction simply as a catalytic one.

#### 6. Summary and Discussion of the Calculations of the Ratio N/M

In examining the ratio of N to M in Table II, one cannot fail to be struck by the fact that for all the reactions studied, the values of M are remarkably close to those of N. This seems particularly significant if one recalls that we are dealing with values of the order of  $10^{18}$  to  $10^{21}$ , and that so far as one might have foreseen, or as far as the author did foresee in beginning his investigations of these factors, M might have any value smaller, or greater than N. This would decidedly indicate an ionic theory for these reactions, or at least, that such a theory must be given thorough consideration before being rejected; but it is not the purpose of the present paper to attempt to decide between a strictly ionic theory and a bombardment theory. As far as we can judge at present, the two might prove essentially identical, but this point will be reserved for fuller discussion in the conclusion of this paper. A few more definite questions, however, will be discussed here.

In the first place, to what shall the deviations in the ratio be attributed, to errors of experiment and calculation, or do they represent real differences of efficiency of the emanation for different reactions? Deviations due to the former causes certainly exist; for example, one must regard the deviations between the different series in Reaction 1 as being due either to experimental errors or to the failure of some of the experimental conditions to meet exactly the assumptions imposed in the calculations. Evidently, in experiments of such a minute and difficult character, which were not planned at all with reference to an examination of the present nature, there will be ample room for both kinds of errors. On the other

N = total ions

TABLE II  
I. Gaseous systems

M = total molecules

Reaction	Calculated from the data of	Designation of M	$\frac{N}{M}$
1a $2\text{H}_2 + \text{O}_2 = (2\text{H}_2\text{O})$	Cameron and Ramsay	$\text{M}_{\text{O}_2}$	1.33
b $2\text{H}_2 + \text{O}_2 = (2\text{H}_2\text{O})$	Cameron and Ramsay	$\text{M}_{\text{O}_2}$	1.66
c $2\text{H}_2 + \text{O}_2 = (2\text{H}_2\text{O})$	Cameron and Ramsay	$\text{M}_{\text{O}_2}$	1.73
d $2\text{H}_2 + \text{O}_2 = (2\text{H}_2\text{O})$	Cameron and Ramsay	$\text{M}_{\text{O}_2}$	2.07
e $2\text{H}_2 + \text{O}_2 = (2\text{H}_2\text{O})$	Cameron and Ramsay	$\text{M}_{\text{O}_2}$	1.16
(130°) $2\text{H}_2 + \text{O}_2 = 2\text{H}_2\text{O}$	Cameron and Ramsay	$\text{M}_{\text{O}_2}$	0.68
2 $2\text{CO} = \text{CO}_2 + (\text{C})$	Cameron and Ramsay	$\text{M}_{\text{CO}}$	0.58
3 $2\text{HCl} = \text{H}_2 + (\text{Cl}_2)$	Cameron and Ramsay	$\text{M}_{\text{HCl}}$	1.42
4 $2\text{NH}_3 = \text{N}_2 + 3\text{H}_2$	Cameron and Ramsay	$\text{M}_{\text{NH}_3}$	4.28
4A $2\text{NH}_3 = \text{N}_2 + 3\text{H}_2$	Usher	$\text{M}_{\text{NH}_3}$	2.74
5 $\text{N}_2 + 3\text{H}_2 = (2\text{NH}_3)$	Cameron and Ramsay	$\text{M}_{(\text{N}_2 + \text{H}_2)}$	4.25
6 $2\text{CO}_2 = 2\text{CO} + (\text{O}_2)$	Cameron and Ramsay	$\text{M}_{\text{CO}_2}$	2.86
7 $\text{H}_2 + \text{Br}_2 = 2\text{HBr}$	Lind	$\text{M}_{\text{HBr}}$	2.0
8 $3\text{O}_2 = 2\text{O}_3$	Lind	$\text{M}_{\text{O}_3}$	2.0 (theory)

## II. Liquid Systems

9 $(2\text{H}_2\text{O}) = 2\text{H}_2 + \text{O}_2$ (RaCl <sub>2</sub> soln.)	Debiere	$\text{M}_{\text{H}_2\text{O}}$	(7.5)
10 $(2\text{H}_2\text{O}) = 2\text{H}_2 + \text{O}_2$ (Emanation)	Cameron and Ramsay	$\text{M}_{\text{H}_2\text{O}}$	3.3
10A $(2\text{H}_2\text{O}) = 2\text{H}_2 + \text{O}_2$ (Emanation)	Usher	$\text{M}_{\text{H}_2\text{O}}$	2.9
11 $(2\text{HBr}) = \text{H}_2 + \text{Br}_2$ (Emanation)	Lind	$\text{M}_{\text{HBr}}$	0.45
12 $(\text{KI in acid soln.}) = (\text{I} + \text{K}^+)$	Lind	$\text{MKI}$	1.92

hand, the deviations that occur for different reactions raise the question as to whether an exactly similar mechanism of reaction is to be assumed in each case. For example, the combination of hydrogen and oxygen to form  $H_2O$  is fairly well explained by making an assumption similar to that used in the ozone reaction, namely, that the active ion is a singly charged oxygen atom which reacts with an ordinary molecule of hydrogen; a similar mechanism does not fit the results for the reactions involving the combination of hydrogen and nitrogen at all; the yield is much smaller, and one must admit, either a recombination of the ions to form the original gases, or a mechanism involving a larger number of charges per molecule, such as, the assumption that only triply charged nitrogen ions act with three oppositely charged hydrogen ions. Such speculations are wholly footless with the present data, and it will not be attempted at all in this paper to propose definite mechanisms for the reactions dealt with, but, nevertheless, it does not seem inappropriate to point out that in any of the reactions treated, it would be possible to choose mechanisms quite within the bounds of our knowledge of the amount of charge sometimes associated with the chemical equivalents involved, such as to bring the N/M ratio approximately equal to unity. It should not be lost sight of that we should have at our disposal, in such an attempt, a much larger variety of gaseous ions, as has been shown by Sir J. J. Thomson,<sup>1</sup> than we are accustomed to deal with, in the case of electrolytes, which would give us a wider range of possibilities. But since there is no hope of being able at present to support experimentally such hypotheses as might be made, we refrain from touching this side of the question, except in so far as our choice of M in Table II may be taken as an indication of what might, in a very general way, be regarded as suggestions of possible mechanisms. This latter statement refers particularly to the choice of  $M_{(N_2 + H_2)}$  in the case of the formation of ammonia from its elements; which, of course,

<sup>1</sup> Sir J. J. Thomson: *Phil. Mag.*, [6] 21, 239 (1911).

is merely one way of looking at the low efficiency in this reaction; in which connection it should be mentioned that Usher found very little ammonia at all by analysis, and attributed nearly the whole diminution in volume to the driving of hydrogen and some nitrogen into the glass walls. It would appear possible that the reaction of formation of ammonia from its elements should be struck entirely off the list as not being comparable with the others, and that we should regard the ions of nitrogen as being relatively *inactive*, which is in agreement with the author's failure to find oxides of nitrogen formed in an experiment on the ozonization of air by emanation (loc. cit.).

In treating the data of Cameron and Ramsay and also of Usher (Sec. 4), only one measurement was taken from each series; it is further desirable to obtain an equation which will fit the whole of a series, in testing the theory which we gain from the experimental evidence presented in Table II. Such an equation will be developed in the following section and applied to the results of the authors mentioned.

#### 7. A Kinetic Equation for the Chemical Reactions Produced in Gases by Radium Emanation

Equation (1) in Sec. 2 may be written in the form:

$$\frac{dN}{dt} = kE_t \cdot P = kE_0 e^{-\lambda t} \cdot P,$$

in which  $k$  is a constant in a given experiment and includes all the terms of (1) not directly introduced into the expression given here, some of which will be seen by inspection to be constant only for a given experiment, or under certain restrictions; for example, the constancy of  $i$ , the specific ionization, depends on circumstances to be discussed later. For the present it will be treated as a constant.

The relation which has been demonstrated to exist between chemical action and ionization may be expressed as follows: —  $\frac{dC}{dt} = \text{const.} \frac{dN}{dt}$ , in which  $dC$  is the change in concentration of the substance undergoing reaction. In the case

where the rate of reaction is being measured manometrically by the decrease in pressure, we may write:

$$-\frac{dP}{dt} = \mu \frac{dN}{dt} \dots \dots \dots (2)$$

where  $P = P_0 - \mu N$ , if  $P = P_0$  for  $N = 0$ .

Combining equations (1) and (2), we write:

$$-\frac{1}{\mu} \frac{dP}{dt} = kE_0 e^{-\lambda t} P; \text{ and } \frac{dP}{P} + k\mu E_0 e^{-\lambda t} dt = 0.$$

$$\log \frac{P}{P_0} = \frac{k\mu}{\lambda} E_0 (e^{-\lambda t} - 1) \dots \dots \dots (3)$$

$$P = P_0 e^{-\frac{k\mu}{\lambda} E_0 (e^{-\lambda t} - 1)} \dots \dots \dots (4)$$

Substituting to introduce  $N$ ,

$$N = \frac{1}{\mu} P_0 \left[ 1 - e^{-\frac{k\mu}{\lambda} E_0 (e^{-\lambda t} - 1)} \right] \dots \dots \dots (5)$$

Equation (3) may be conveniently employed as a velocity of reaction equation and has been applied to the results of Cameron and Ramsay to determine the values of  $\frac{k\mu}{\lambda}$ , which is in the nature of a velocity constant. First let us proceed to evaluate  $\frac{k\mu}{\lambda}$  by defining the separate terms.  $\lambda$  is, of course, the constant for the rate of decay of emanation =  $2.085 \times 10^{-6} \text{ sec}^{-1}$ .  $\mu$  is an efficiency factor for the chemical effect of the ions, and may be defined from equation (2) as the change of pressure produced through the chemical action brought about by the production of *one ion* in a given gas system, and its reciprocal is numerically equal to:  $\frac{a \cdot 2.69 \cdot 10^{19} \cdot V}{760} = \frac{1}{\mu}$ , in which  $a = \frac{N}{M}$ . It should be noted that this  $\frac{N}{M}$  value is not always the one given in the last column of Table II, but refers here only to the *actual* change in volume and can be obtained directly from the former by use of a suitable factor, obtained from inspection of the respective

reaction formulæ.  $k$  is the ionization coefficient and may be defined through equation (1) above and in Section 2, as the number of ions produced in 1 second, in air at 1 atmosphere pressure, by the  $a$  particles from 1 Curie of emanation in equilibrium, in a volume of such size that the average path of all the particles, counted from the origin, is 1 cm. The numerical value of  $k$  is  $1.258 \cdot 10^{12} \cdot V^{1/2} \cdot i$ . Therefore  $\frac{k\mu}{\lambda} = \frac{17.0 \cdot i}{a \cdot V^{1/2}} =$  a constant, which cannot be calculated *a priori*, because the value of  $a$  must first be determined from experimental data, as in Sec. 4, but once having been determined for one member of a series, a value of  $a$  can be calculated which should agree with that obtained directly by application of equation (3) to the series.

The assumption made above that  $i$  remains constant during an experiment is of course not strictly true, unless the reacting gases are initially present in stoichiometric proportions and all the products of reaction are removed from the gas phase as they are formed. This would be the case, for example, in the combination of  $H_2$  and  $O_2$  starting with electrolytic gas. But when the relative composition of the gases is changed in any way as the reaction proceeds, for example where the products are not removed,  $i$  would not remain strictly constant; but in most of the data used, the reaction does not proceed far enough to change materially the composition of the gases and in all the experiments of Cameron and Ramsay  $i$  has been regarded as constant. In Experiment III (loc. cit., p. 394) of Usher on the decomposition of ammonia, however, the reaction proceeds to more than 50 percent of total reaction and some special conditions arise which must be considered;  $i$  may still be regarded as constant, since both the  $H_2$  and  $N_2$  (combined and free) remain in a volume which is held constant and the additive principle doubtless applies so closely that the ionization per  $a$  particle remains practically constant, but a more important question presents itself; if the back reaction is negligible, as Usher claims, is it only that ionization produced in the ammonia itself,

which is effective in bringing about decomposition or must one consider the total ionization? If the latter were the case, then the rate of reaction would be independent of the concentration of the ammonia and vary only with the decay of emanation, which Usher has clearly shown not to be the case, and which is further substantiated in this article by the fact that a much better constant is obtained by applying equation (3) using *partial pressure* of ammonia than when the *total pressure* is employed, and even then the constant still shows a *fall* which will be discussed later.

In Table III will be found the application of equation (3) to some of the data of Cameron and Ramsay and of Usher.

TABLE III

$$\text{From equation (3), const.} = \frac{k\mu}{\lambda} = \log \frac{P}{P_0} / E_0(e^{-\mu} - 1)$$

(Numbers of reactions refer to those used in Table II)

Reaction 1a. $2\text{H}_2 + \text{O}_2 = (2\text{H}_2\text{O})$ (moist)			Reaction 1c. $2\text{H}_2 + \text{O}_2 = (2\text{H}_2\text{O})$ (dry)		
<i>t</i>	P	$\frac{k\mu}{\lambda}$	<i>t</i>	P	$\frac{k\mu}{\lambda}$
0	523.5	—	0	577.6	—
1.02	487.0	(9.3)	1.96	552.4	6.5
2.07	442.0	(11.7)	2.84	546.9	6.2
3.07	405.6	12.9	3.8	535.6	6.9
4.13	384.5	12.7	4.8	530.2	6.7
4.99	369.5	12.8	6.8	521.5	6.6
6.11	352.2	12.8	9.9	505.6	7.3
7.07	343.5	12.6	11.9	502.8	7.2
9.11	321.4	13.0	13.9	496.4	7.5
10.16	319.3	12.7	15.0	496.9	7.2
11.04	316.6	12.5	15.8	500.2	7.0
12.10	312.3	12.5	16.9	501.7	6.7
97.0	291.0	12.6	21.9	493.3	7.3
	<i>Mean</i>	<i>12.71</i>		<i>Mean</i>	<i>6.9</i>

TABLE III—(Continued)

Reaction 2. $2\text{CO} = \text{CO}_2 + (\text{C})$			Reaction 3. $2\text{HCl} = \text{H}_2 + (\text{Cl}_2)$		
$t$	P	$\frac{k\mu}{\lambda}$	$t$	$v^1$	$\frac{k\mu}{\lambda}$
0	297.0	—	0	2.464	—
0.81	282.2	17.2	0.7	2.454	26.3
1.89	263.0	17.9	1.9	2.204	16.5
2.8	251.0	17.8	2.7	2.086	12.7
3.8	245.0	16.1	3.8	2.079	10.6
4.8	233.0	17.3	5.8	2.038	8.5
5.8	225.0	17.5	9.8	1.985	7.6
6.8	221.6	17.0	13.8	1.949	6.4
10.1	218.0	15.2	18.8	1.930	7.3
14.8	206.2	16.0	23.9	1.926	7.2
19.9	208.4	14.9	25.8	1.903	7.6
23.8	201.4	15.1	—	—	—
26.8	200.2	16.2	—	—	—
	Mean	16.5			

Reaction 4. $2\text{NH}_3 = \text{N}_2 + 3\text{H}_2$			Reaction 4A. (Usher) $2\text{NH}_3 = \text{N}_2 + 3\text{H}_2$		
$t$	P	$\frac{k\mu}{\lambda}$	$t$	$v^1$	$\frac{k\mu}{\lambda}$
0	807.1	—	0	0.909	—
0.9	828.3	0.15	0.07	0.895	8.3
1.9	864.7	0.21	0.76	0.781	8.2
2.2	883.0	0.24	1.08	0.735	8.3
2.9	911.0	0.26	1.75	0.664	8.0
4.9	942.4	0.23	2.08	0.630	8.1
6.9	964.4	0.22	2.78	0.581	7.9
10.1	974.2	0.20	3.75	0.527	7.7
11.9	979.0	0.19	4.75	0.493	7.4
	Mean	0.21	6.75	0.441	7.1
			7.75	0.431	6.8
			8.75	0.421	6.7
			13.77	0.399	6.2
			32.0	0.385	5.9

<sup>1</sup> Cf. later in this section.



TABLE III—(Continued)

Reaction 5.  $N_2 + 3H_2 = (2NH_3)$ 

$t$	P	$\frac{k\mu}{\lambda}$
0	745.6	—
0.79	720.8	(2.15)
1.76	714.1	(1.34)
2.77	707.6	(1.13)
3.77	701.6	1.04
4.85	694.3	1.03
5.77	690.1	1.01
6.76	686.6	0.98
7.76	683.1	0.98
9.76	677.1	0.97
11.0	675.0	0.97
12.8	672.4	0.96
14.8	671.9	0.98
17.9	669.1	0.94
		0.99
	Mean	0.99

The values of  $\frac{k\mu}{\lambda}$  in Table III are comparable only within each series because the factors  $V$  and  $a$  are still involved, which, of course, vary from one series to another. (In Table IV will be found values for a final constant.) From the foregoing table one sees that Equation (3) expresses quite well the course of the chemical action of gases in confined volumes under the influence of radium emanation, and little explanation is needed. The highest degree of constancy is obtained, just as would be expected, in an experiment where the actual conditions most nearly correspond to those assumed in the development of the equation. For example, in reaction 1a, where the vessel was truly cylindrical and no reagent was added which might have disturbed the free paths, and where  $i$  remained really constant through continued removal of the products from the field of action, the constant  $\left(\frac{k\mu}{\lambda}\right)$  is best, and is quite comparable with the velocity constants obtained

in ordinary chemical reactions, under the best conditions, the average deviation being of the order of 1 percent.

The poor constant for the decomposition of HCl indicates that some rather large experimental error, or abnormal influence, was introduced near the beginning of the reaction, which will also be seen from Table V to follow, and, indeed the authors do not claim any degree of accuracy for this experiment, but it has been included with the others as being the only available data for a very interesting reaction. After the initial period is passed in Reaction 5, the constant is very good, indicating that whatever the reduction in pressure is due to, it follows the same law as the other reactions, although Usher found little or no  $\text{NH}_3$  had been formed. The constant obtained in Usher's measurement of the decomposition of  $\text{NH}_3$  (Reaction 4A) shows a distinct drop, even though the calculation has been carried through for partial pressure. This drop is not greater than would be accounted for by a reverse reaction of the magnitude represented in the pressure change, but failure to find any ammonia in the analysis is puzzling. Of course, one could imagine that the presence of the decomposition products  $\text{N}_2$  and  $\text{H}_2$  might, in some way, interfere with the further decomposition of  $\text{NH}_3$ , but without further data as to the influence of one gas on another with respect to ionization and reaction, this is mere speculation; and it is far more logical to say that the drop in the velocity constant can be accounted for by the fall in pressure observed in the exposure of  $\text{H}_2$  and  $\text{N}_2$  to  $\alpha$  radiation. Whether  $\text{NH}_3$  is really formed or not, makes no difference, because in either case it would appear in the manometric method as a reduction in the efficiency of the ammonia decomposition, even if it represents nothing more than the driving of  $\text{H}_2$  and  $\text{N}_2$  into the glass wall by the  $\alpha$  particles.

In order to employ equation (3) for a reaction in which the pressure is increasing instead of decreasing (cf. Reaction 4, Table III), it requires a slight modification. In equation (2), (Sec. 7), from which equation (3) was developed, it is

only necessary to change the sign of  $\frac{dP}{d}$ , which results in inverting the logarithmic fraction in equation (3). As we have mentioned in connection with Reaction 4A of Usher, it appears that it is the *partial pressure* of the substance being acted on, which one must consider, and not the total pressure; in which case one would never have increasing pressure to deal with. But in Reaction 4 of Cameron and Ramsay in which the percentage change is smaller, it makes no difference in the values of the constant, which method is used; total pressure was used for the sake of uniformity. It is also evident that the ratio  $\frac{v}{v_0}$  may be used in place of  $\frac{P}{P_0}$  in equation (3), which has been done in Reaction 4A, Table III.

The expression given earlier in this section for  $\frac{k\mu}{\lambda}$  may be transposed into:  $\frac{k\mu}{\lambda} \cdot \frac{a \cdot N^{1/a}}{i} = \text{const.} = 17.0$ . In Table IV are given the values obtained from the experimental data of Cameron and Ramsay; the numbers of the reactions are the same as those already used in Tables II and III. This does not constitute an independent test of the validity of equation (3), because it involves the values of  $a$ , which were determined by first assuming the validity of (3), but since the *mean value of pressure* was used instead of an *integral* value, the differences between the constant found and its theoretical value 17.0, do serve to show within what limits the assumptions involved in the calculations in Section 4 are correct. The agreement is quite within the other limits of error, and it has not been considered necessary to calculate backward from the experimental mean of  $\frac{k\mu}{\lambda}$  for new values of  $a$ , because the change would be too slight to produce any changes in the general order of the deviations, even within the same reaction (cf. 1a to 1e). It should also be borne in mind that the ratio N/M refers here to the *actual* change in volume, and that M is perfectly general and refers to no one component (cf. N/M in Section 4).

TABLE IV

Reaction	V	$a = \frac{N}{M}$	$i$	$k\mu_{\lambda}$ (expt. mean)	Const. (theory = 17.0) (found)
1a	1.685	0.45	0.54	12.7	17.8
1b	1.982	0.56	0.54	8.5	17.5
1c	2.925	0.47	0.54	7.0	17.8
1d	2.275	0.70	0.625	7.2	18.3
1e	1.350	0.40	0.54	19.2	18.7
2	1.830	1.15	1.00	7.9	16.7
3	2.149	1.42	1.28	7.6	18.1
4	1.496	4.28	0.83	0.21	16.2
5	1.741	4.25	0.415	0.99	17.6

### 8. Discussion of the Conclusions Reached by Cameron and Ramsay and by Usher

After having largely employed data of these authors in considering the nature of the chemical action of gases under the influence of the  $a$  particles, it may be well to compare their conclusions with the ones arrived at here. The most important general conclusion reached by Cameron and Ramsay was that the chemical action is proportional to the amount of emanation present and falls off as the latter decays. There is no doubt of the general truth of this principle; it is exactly what one should expect, and its experimental demonstration is an essential step in establishing a correct theory for these effects. It does not mean, however, that a given amount of emanation in a given gaseous system will produce the same amount of action in the first half of its decay as in the second half, as claimed by Cameron and Ramsay, because the concentration of the gas being acted on, is being diminished and one should expect to get a smaller effect in the second half-period than in the first, which would mean that the half-period of the chemical reaction should be shorter than that of the emanation. If, however, a large excess of gas is present above the quantity that will be acted on during the life of the emanation, the relative change of concentration may become negligible in comparison, and this is the real reason why Cameron

and Ramsay found the two half-periods approximately to coincide, because their relative pressure changes were in most cases small. A second factor that contributed to an accidental agreement was the circumstance that they chose only the results from the action on water and on electrolytic gases for the comparison. In order to make this and other points clearer, let us examine the following table, which presents their results in a form suitable for the present purpose. The numbers of the experiments refer to those of the original article (*loc. cit.*),  $P_0$  is the initial, and  $P$  the final pressure.  $A_1$  is the action during the first half-period, 3.85 days, and  $A_2$  is the action in the second half, each expressed in terms of  $\text{cm}^3$  of volume change per 1 Curie of emanation:

TABLE V

Reaction	No of expt.	$P_0$ (cms)	$P$ (cms)	$A_1$	$A_2$
$2\text{H}_2 + \text{O}_2 = (2\text{H}_2\text{O})$	4	52	29	8.4	6.0
$2\text{H}_2 + \text{O}_2 = (2\text{H}_2\text{O})$	5	56	50	7.8	9.8
$2\text{H}_2 + \text{O}_2 = (2\text{H}_2\text{O})$	6	58	49	12.5	12.6
$2\text{H}_2 + \text{O}_2 = (2\text{H}_2\text{O})$	7	34	23	4.7	5.5
$2\text{H}_2 + \text{O}_2 = (2\text{H}_2\text{O})$	8	47	24	7.2	7.9
$2\text{H}_2 + \text{O}_2 = 2\text{H}_2\text{O}$ (at $130^\circ$ )	(only 5.73 hours)			—	1.2
$2\text{CO} = \text{CO}_2 + (\text{C})$	3	30	25	3.9	3.2
$2\text{HCl} = \text{H}_2 + (\text{Cl}_2)$ (p. 984)		28	22	11.7	4.5
$2\text{NH}_3 = \text{N}_2 + 3\text{H}_2$	3	81	98	1.9	1.2
$\text{N}_2 + 3\text{H}_2 = (2\text{NH}_3)$ (p. 988)		75	67	1.1	0.85

As one sees from this table, in all the reactions except the combination of  $\text{H}_2$  and  $\text{O}_2$ ,  $A_1$  is larger than  $A_2$ , as would be expected from the diminution in concentration of the gases; the very large difference in the case of  $\text{HCl}$  is doubtless abnormal, as was indicated in Section 7, but the other differences are about what one would predict. But in the reaction of  $\text{H}_2$  and  $\text{O}_2$ ,  $A_2$  is with one exception greater than  $A_1$ ; the only case in which a distinct drop occurs is in Exp. 4, in which the pressure change is relatively large; in Exp. 8, on the other hand, where the pressure change is equally great, there is again a slight increase of  $A_2$  over  $A_1$ . Now the theory

of Cameron and Ramsay is equally unable to account for  $A_2$  being *greater* than  $A_1$ , and it seems evident that some abnormal influence was at work here to raise the value of  $A_2$ , and it may just as well have raised it from a value lower than  $A_1$  as from one equal to it, and the fact that all the other reactions are in accord with the present theory must be given due weight.

Cameron and Ramsay failed to recognize the necessity of taking into consideration the volume, the concentration, the length of path and other factors which present themselves for consideration if one admits that it is an effect of the  $\alpha$  particle. They seemed to find it somewhat anomalous that the efficiency appeared lower for the reaction at  $130^\circ$  (cf. Table V) than in their other reactions, but the reason becomes very apparent if one takes into consideration the fact that the volume in this case was reduced to  $0.1197 \text{ cm}^3$  (cf. Reaction *f*, Sec. 4) and the paths were, consequently, much shortened. From the N/M values in Table II, one sees that, on the ionic theory, the efficiency was really increased about two-fold for a temperature difference of about  $110^\circ$ , which would correspond to a positive temperature coefficient of about 1.06 per  $10^\circ \text{ C}$ , which is exactly of the order of the temperature coefficients of many photo-chemical reactions.

Although Cameron and Ramsay do not absolutely reject the idea that these reactions may be an effect produced by  $\alpha$  particles, they do not mention it in their final conclusion which we will quote: "For the present we content ourselves with reiterating the chief conclusion reached in this paper, that, whenever radium emanation produces chemical action, then, other conditions being unaltered, each particle of emanation as it disintegrates produces the same amount of change." Of course this statement, in the light of our present theory, cannot be taken literally, because the effect that a molecule of emanation will produce, depends on the length of the path that its  $\alpha$  particle happens to take; if it went directly into the glass wall it would produce no effect at all, so far as the gas is concerned. But allowing a little broader interpretation of their statement and admitting that they might refer

to the *average* effect of all the molecules of emanation in disintegrating, we still have a statement that is not correct without imposing the conditions of volume, pressure, and any others which could influence the number of ions formed, or the number of impacts. The only thing in the work of Cameron and Ramsay that, at first sight, seems to argue strongly against the hypothesis that the  $\alpha$  particles are the agents, is their objection that the velocity curve for the combination of  $H_2$  and  $O_2$  at  $130^\circ$  should, during the first *three or four hours*, show an accelerated effect owing to the increase of induced activity, and this did not appear to be the case. Let us examine the validity of this objection by inspection of the velocity curve<sup>1</sup> in question. The first thing that arrests the attention is the fact that, *during the first hour*, an actual *increase* in volume was taking place, instead of the gradually accelerated *decrease* to be expected, which means that during this time some other cause completely obscured the true course of the reaction. One must take into account also that the half-periods of Radium A, B, and C, are only 3.0, 26.7 and 19.5 minutes, respectively, so that, although it is true that it takes about three hours for emanation to get *completely* into equilibrium, yet the percentage lacking at the end of one hour is too small to make a noticeable difference on their velocity curve, and we should expect that when the reaction emerges at the end of an hour from the disturbing influence, whatever it may have been, it would then pursue its regular course, as they observed. With this point cleared up, there remains nothing in the data of Cameron and Ramsay which does not support the ionic theory of the nature of the chemical effect produced by emanation, or at least a theory of bombardment of some kind, by  $\alpha$  particles.<sup>2</sup>

The fact that no decomposition of steam could be observed at  $130^\circ$  forms a singular contrast to the action on liquid

<sup>1</sup> Loc. cit., Fig. 10, p. 989.

<sup>2</sup> The fact that its action can not be due to a direct *contact influence* of the emanation, in any sense, is directly demonstrated by the production of the effect outside a thin glass wall in the case of ozone formation.

water, and I should expect that repetition under more favorable conditions would show the ionic efficiency to be about the same as in other cases.

In his paper on the decomposition of ammonia, which followed that of Cameron and Ramsay about two years later, Usher<sup>1</sup> begins with the assumption that the former had shown the chemical action to be due to  $\alpha$  particles, but makes a distinct advance in recognizing that the efficiency could be increased by increasing the volume of the reacting gases, and that the "action cannot be regarded as catalytic in any sense, and is probably mechanical or electrical in origin." He moreover went so far as to calculate the total number of molecules of ammonia decomposed per molecule of emanation in a large volume (2 liters), which he found to be 134,300, and estimated this to be about 90 percent of the maximum possible efficiency. This estimate of efficiency is probably too high, as can be shown in two ways: in the first place, no matter how large the vessel, the induced activity will be situated mainly on the walls, and hence in the most unfavorable position, for half of the radiation is lost at once into the wall; in the second place, the maximum number of ions that a molecule of emanation can produce, in complete absorption in air of all three  $\alpha$  particles, is about 600,000, and in ammonia we have estimated it would be about 0.83 times this or, about 498,000. The N/M value which we calculate for Usher's experiments in small volumes (using the partial pressure) is 1.81, and we may calculate the total number of NH<sub>3</sub> molecules that would be decomposed as  $\frac{498,000}{1.81} = 276,000$ . 134,000 molecules of NH<sub>3</sub> per 1 molecule of emanation is then, perhaps, not more than 50 percent of the optimum value, which could never be reached, however, while having the emanation mixed with the gases being acted on, but might be approached more nearly by having the emanation confined in a very thin-walled bulb (such as the author used for the

<sup>1</sup> Usher: Loc. cit.



experiments with ozonization) in order to utilize the  $\alpha$  rays in all directions.

At any rate, it is interesting to see how closely Usher approached to the ideas of the ionic theory here proposed; and it is equally interesting to see how far he later got away from it, in his work on the decomposition of liquid water (loc. cit.), which we shall discuss in detail shortly, as having a vital bearing on the present paper. But before leaving the subject of gases, a brief consideration of the equations which Usher applied to his results is not without interest. Regarding the reaction as an irreversible monomolecular reaction, and assuming provisionally that its rate is independent of the quantity of emanation present, Usher tested the constancy of the relation:  $\text{const.} = \frac{1}{t} \log \frac{V_o}{V_t}$  and, as he expected, did not find any degree of constancy whatever, which merely states that the reaction is not a monomolecular reaction catalyzed at a rate independent of the concentration of emanation. He then tried the assumption that the velocity of reaction is proportional both to the amount of emanation and of ammonia present at any time, an assumption entirely correct and in accord with the ionic theory, but owing to an unfortunate mode of developing his equation by again starting with an independent first order reaction, he arrives at the form:  $\text{const.} = \frac{1}{t \cdot E_t} \cdot \log \frac{V_o}{V_t}$ , which may be written:  $\text{const.} = \frac{1}{t(E_o e^{-\lambda t})} \cdot \log \frac{V_o}{V_t}$ , which must mean that the reaction is produced by two independent causes, since the time factor appears twice in the equation, which means nothing more than that a first order reaction is being catalyzed by emanation in proportion to its concentration; and again no constancy was found. The essential difference, then, between this kind of assumption and the one which I have employed, will be apparent by examination of the equation already used in this paper,  $\frac{k\mu}{\lambda} = \frac{\log p - \log p_o}{E_o(1 - e^{-\lambda t})}$ , in which it will be noticed that the time factor appears only once, which

expresses the fact that the rate of the gas reaction is proportional to the amount of emanation present at any time  $t$ , only in so far as the emanation is instrumental in producing a change in the gas, as a result of which, an *immediate, not a time reaction*, takes place, which would not proceed at all without the action of the emanation. By dropping  $t$  from the denominator of Usher's equation, one is obtained essentially identical with equation (3).

It is also to be noted that no factor in regard to ions appears in our equation (3), and its validity would be preserved quite independently of its interpretation in this respect. The strong evidence in favor of the ionization theory comes through the fact that  $N$  and  $M$  have nearly the same values. It has also been shown that the equation proposed by us fits the data of Usher fairly well, although there is still some residual fall in the constant which attests to the accuracy of his experimental results, since the average deviation is not greater than in other experiments in which no fall or rise is apparent. It has also been pointed out that this residual fall would be eliminated, either by taking into account a reverse reaction or a diminution in pressure owing to driving gas into the wall. Since the differential equation expressing this is somewhat complicated, its integration has not been undertaken, but inspection shows that the two effects are about of such a magnitude as would counterbalance each other. Usher's assumption of an "efficiency" proportional to the ratio of gas molecules to atoms of emanation, introduces a corrective factor which is in the right direction, but appears to have no direct theoretical bearing, and the constants obtained with it were not altogether satisfactory.

Finally we come to a consideration of Usher's experiments on the individual and combined effects of  $\alpha$  and  $\beta$  rays in the decomposition of water. Its direct bearing on this article is evident from the fact that we have entirely neglected the chemical effect of the  $\beta$  rays as being proportional to their relative ionizing power, and hence so subordinate to that of the  $\alpha$  particles, as to justify such a disregard. But

if Usher is right in claiming that the chemical effect of the total  $\beta$  rays from emanation may amount to as much as *one-half* that of the  $\alpha$  particles, our entire hypothesis and conclusions must be wrong. Usher's actual data show, however, that he obtained by a month's action of 0.067 mm<sup>3</sup> of emanation on water, through a capillary tube of glass 0.17 mm thick, electrolytic gas to the extent of 0.208 cm<sup>3</sup>; and that by the direct action of 0.025 mm<sup>3</sup> of emanation, he obtained 5.840 cm<sup>3</sup>.<sup>1</sup> (This latter decomposition has already been shown in ~~Reaction 10A, Section 5, to be in close accord with the predictions of the ionic theory.~~) The joint effect of the rays is then about *75 times* as great as that of the penetrating rays alone; or, the effect of the latter is about 1.3 percent of the whole, which is about what one would expect either from their relative ionizations or their kinetic energies, and would appear to support our theory fully. The question then arises how Usher gets from a 75-fold effect to a 2-fold one; he does so through considering what effect the other, less penetrating  $\beta$  rays would have produced, had they been able to penetrate the glass wall, *assuming that every  $\beta$  ray would produce the same amount of decomposition independent of its velocity, penetration or kinetic energy.* Apparently, this view was taken in an effort to find a relation between the amount of chemical decomposition and the electrical charge carried by the various particles, though it is not clear exactly what the quantitative relation would be. We trust that this paper demonstrates that such a comparison should be made through consideration of the charges *produced by the moving particles, not by the charges which they themselves carry*, a number that is wholly insufficient to account for the effect in any sense consistent with electrical-chemical equivalence, even though all the soft  $\beta$  rays were called into requisition. Of course, it is evident that the ionic theory, or any kinetic theory, will not allow that the soft  $\beta$  rays should produce any large amount of reaction in a system requiring the expenditure of energy

<sup>1</sup> An excess of 0.634 cm<sup>3</sup> of H<sub>2</sub> is treated here as representing electrolytic mixture.

for its decomposition; the mere fact that the soft  $\beta$ -rays do not penetrate, means that they have not sufficient kinetic energy either to ionize or to produce chemical effect. After Usher had reached such correct conclusions as to efficiency and kinetic energy relations in his earlier paper on the decomposition of ammonia, it is difficult to understand why he should be led to return to what must be regarded as essentially a catalytic theory for the decomposition of water; it must have arisen through a false conception that one is dealing with a ~~totally different kind of reaction in liquid systems from that~~ in gases. We have tried to show in this paper that this is so far from being the case, that one may regard the nature of the reactions in both systems as essentially identical.

Fortunately, however, we are not dependent on indirect evidence alone in testing the validity of Usher's claim of the power of the very slightly penetrating  $\beta$  rays, that is, those with ranges of the order of 1 mm or less to produce chemical action. In the experiments of the author on ozone formation (loc. cit.), the  $\alpha$  particles emerged through a glass wall having an absorptive power equivalent to one or two centimeters of air, which was far more than sufficient to cut off all soft  $\beta$  rays, and yet we find an effect exactly of the same order as those obtained in other reactions where emanation is mixed directly with the gaseous or liquid system, and corresponding to the prediction of the ionic theory. *In conclusion we feel justified in maintaining that there is no experimental evidence that the chemical action of  $\beta$  rays is ever more than a very subordinate one compared to that of  $\alpha$  particles.* One would expect that this should be so in any action requiring the expenditure of energy, as, for example, the decomposition of water. In fact, we know of only one case in which a larger effect had been observed than to be expected from the ionization, namely the combination of hydrogen and chlorine under the action of penetrating rays, a reaction proceeding, however, in the direction of the free energy. This interesting reaction we reserve for brief consideration later.

Of course the question presents itself, if the chemical activity of the  $\alpha$  particles is so general both in liquid and gaseous systems and, in many cases, apparently of the same order of magnitude will it not also be true for *solids*, and should one not expect that a substance like phosphor pentoxide or even the glass walls themselves would be decomposed and thus disturb the course of the gas reaction being measured manometrically? This is certainly a question that deserves some consideration, for we know that the coloration of glass and even of quartz and other minerals has been very generally observed, and that sometimes, after long exposure, actual mechanical disintegration of glass or quartz sets in. As yet there are almost no quantitative data for the action of the radiation on solids, but there is good reason to believe that it is of a lower order than that for gases and liquids, which doubtless is related to the absence of diffusion in solids, so that the conditions for recombination would be at a maximum, because the decomposition products must remain in intimate contact.

The author had the opportunity of making a preliminary examination of this subject in the Radium Institute of Vienna, which shows that the effects are certainly very small. The four salts KI, PbI<sub>2</sub>, PbBr<sub>2</sub>, and PbCl<sub>2</sub>, filling glass tubes about 1 × 8 cm and 0.5 mm thick were arranged about a glass tube of somewhat smaller dimensions, containing 260 mg of radium chloride, and were left for 34 days, at the end of which time they were opened and treated with KI solution to extract any of the free halides. Titration with 1/200 N thio-sulphate solution showed only 0.20 cm<sup>3</sup> for KI; 0.22 for PbI<sub>2</sub>; 0.00 for PbBr<sub>2</sub>; and 0.15 for PbCl<sub>2</sub>. There is too great a degree of uncertainty to justify an estimation of the amount of ionization, but it is evident that the chemical effect was very small, although the source of radioactivity was a strong one, acting over a fairly long period with undiminished intensity.

#### 9. Conclusion

The principal object of this paper has been to demon-

strate that in chemical reactions brought about through the agency of  $\alpha$  particles, the number of molecules undergoing change is approximately equal to the number of ions produced in the given gaseous or liquid system being acted on. The exact significance of this relation is not at once apparent, though its seeming general validity must be regarded as suggestive in many directions. It has been shown to hold for all the present available data. It may or may not be true for a large number of other systems, but it does not appear at all improbable that it will prove so, especially for reactions of decomposition in such cases where there is little tendency or opportunity for recombination of the products.

The possibility which has been demonstrated here of predicting, in many cases, the quantity of chemical transformation under radioactive influence from another of its quantitatively measurable effects, the ionization, distinguishes this type of action from the other actino-chemical reactions. In photo-chemistry, for example, one has not been able to find general relations between different reactions; the effects are very specific, both qualitatively and quantitatively for different systems. Quantitative methods of dealing with the absorption of light and its transformation into chemical action are at present conspicuously lacking. There is a possibility that ionization plays an important role also in photo-chemical effects, and that electrical methods may prove of service in their study.

It is fully realized that the mere equivalence of the chemical and electrical effects does not constitute a proof that it is the ions that are instrumental in bringing about the chemical action, and in the case of reactions of decomposition a theory of mechanical bombardment may seem more plausible, but, on the other hand, the ionic theory seems to suit better for reactions of combination; and, as has been previously suggested, there may be no real difference between the two theories after all. Of course, in the case of reactions which require an expenditure of energy for their accomplishment, such as the decomposition of water, or of ammonia, or

of hydrogen chloride or bromide, one should expect that the amount of the effect produced by an  $\alpha$  particle should have a definite limited value, and might interpret our results to mean merely that the quantity of *kinetic energy* necessary to produce ionization is about the same as that necessary to produce chemical decomposition. But this will not explain at all why the effect, in the case of reactions proceeding in the direction of the chemical free energy, should also show the same degree of equivalence between the number of ions and the molecules reacting; one might have supposed that the efficiency would be much greater here and of a *catalytic* nature. This brings us to mention the reaction between hydrogen and chlorine measured by Jorissen and Ringer,<sup>1</sup> which we have already referred to as being the only instance, with which the author is acquainted, where the chemical effect is largely in excess of the probable ionization. The reaction was produced by a very weak source of penetrating radiation; and from an approximate estimation of the author, the effect appears to have been from one hundred to one thousand times greater than could be accounted for on the theory of ionization; this would seem to put this particular reaction back into the catalytic class. There is, however, a possibility that there may be an abnormal auto-ionization in the case of chlorine gas, which is also suggested by its abnormal action in other reactions such as photochemical ones. Bragg<sup>2</sup> has found, however, that the ionization of some organic compounds containing chlorine, is perfectly normal, so that if such a tendency for abnormal auto-ionization really exists, it must be exhibited only by elemental chlorine, or by it in the moment of reaction. However an attempt of J. J. Thomson<sup>3</sup> to detect ionization in the photochemical action between hydrogen and chlorine gases resulted negatively.

One of the most significant results of this investigation is the fact that the efficiency of emanation seems to be of the

<sup>1</sup> Jorissen and Ringer: *Ber. chem. Ges. Berlin*, 39, 2093-8 (1906).

<sup>2</sup> Bragg: *Loc. cit.*

<sup>3</sup> *Proc. Camb. Phil. Soc.*, 11, 90 (1901).



same order in a reaction proceeding in the direction of its own chemical free energy as opposed to it; there is no indication of an additional catalytic effect in the former case. In other words, it appears that it is necessary to do the same amount of work on the gas particles before they are in a state to react chemically, no matter what the direction of the reaction. This of course suggests many interesting conjectures as to the nature of explosive reactions, and the propagation of flames, etc., as possibly being closely connected with auto-ionization, but the author is not at present prepared to do more than offer these suggestions.<sup>1</sup>

This whole question of chemical and electrical equivalence in gas reactions is certainly most suggestive when considered in the light of the proposed electrical constitution of matter, and cannot fail to lead one to seek a modified form of Faraday's laws for their explanation. In this connection it is interesting to note that Warburg,<sup>2</sup> at the termination of his extended researches on the production of ozone by silent and spark discharges, rejected the idea that there was any connection between the electrical effect and the quantity of ozone produced, preferring to regard ozonization as an effect of ultraviolet light. Judging from the analogy suggested by the radioactive effects, it seems quite clear that one should compare its chemical effect, not with the current which passes, but with the number of ions produced by shock which do not reach the electrode; it is not the charges which reach the electrode that are equivalent to the chemical effect, but the far larger number of charges that are produced on the way by the moving charged particles; in the same way that it is not the charges carried by the  $\alpha$  and  $\beta$  rays, but the immensely greater number of ions produced by them, which seem to act

<sup>1</sup> NOTE.—An investigation was made on the explosive combination of electrolytic gases by Haselfoot and Kirkby (*Phil. Mag.*, [6] 8, 471 (1904)) in which the electrical effects appeared very small. Relatively much larger effects have been obtained by Haber and Just (*Drude's Ann.*, 36, 308 (1911)) in the combination of the alkali metals with several gases, but the ratio still remains far below equivalence.

<sup>2</sup> Warburg: *Sitzungsber. Akad. Wiss. Berlin*, 1904, et seq.



chemically, or are, at any rate, approximately equivalent to the chemical action. Correspondingly, it seems quite possible that the conditions under which ozonization is produced by silent and by spark discharges suggest that each unit charge that reaches the electrode may have produced in its path several hundred ions which react to form ozone, which number would be sufficient to account for all the ozone found by Warburg.

Finally, we have to consider briefly the possible bearing of our subject upon a very important electrical method of measurement, namely the attainment of saturation current in an ionized gas. It has been customary to take into account mainly the attraction of the oppositely charged ions for each other in dealing with the force necessary to be applied to draw all the ions to the electrode, although Bragg<sup>1</sup> proposed some time ago to consider a second factor, that of immediate recombination of the ion with its parent molecule. If, however, the ionic nature of the chemical reactions is admitted, then the fact that the yield in many cases is a large fraction of 100 percent of theory, indicates that, at ordinary pressures, the tendency of the ions to react with the neutral molecules is much greater than to recombine to form the original gas, and, hence, that this factor of molecular attraction for the charge, is, perhaps, the chief one to be considered with respect to the attainment of saturation current at ordinary pressures.

The main conclusions of this paper may be summarized as follows:

1. In all of the gas reactions that have been reported by various authorities, the chemical effect produced by the  $\alpha$  particles is determined by the number of gaseous ions formed. Hence, it is necessary to take into account all the conditions regarding pressure, length of path, etc., which govern the formation of ions, in considering the efficiency of emanation in these systems.

<sup>1</sup> Bragg: *Phil. Mag.*, [6] 11, 466 (1906).

2. A method is proposed for the calculation of the average path of  $\alpha$  particles in small spherical and cylindrical volumes which enables one to estimate the consequent ionization of a gas by emanation in such volumes.

3. The close equivalence between the number of ions formed and the number of molecules that react chemically, may be regarded as being at least indicative that it is the ions which constitute the primary agents of reaction (though other possibilities are recognized). Thus it becomes possible in many cases to predict the order of magnitude of reaction produced in a given system by radioactive agencies.

4. The action of the  $\alpha$  particles is in no sense to be regarded as a *catalytic* one. The same principle is found to hold for reactions proceeding with the chemical free energy as opposed to it.

5. Reactions in liquid systems are apparently of the same nature and obey the same general laws as those in gases, with respect to the  $\frac{N}{M}$  ratio.

6. There is no experimental evidence that the action of  $\beta$  rays ever exceeds the subordinate proportion that corresponds to the relative amount of ionization produced by them as compared with that by  $\alpha$  particles (unless in the very exceptional reaction between hydrogen and chlorine).

7. A kinetic equation is proposed which fits the present available data on the rate of gas reactions under the influence of radium emanation.

Laboratory of Physical Chemistry  
University of Michigan,  
June 7, 1912

## GLYCEROL AS SENSITIZER<sup>1</sup>

BY CHARLES W. BENNETT

Three years ago von Hübl<sup>2</sup> published some work on the bleach-out process. He added glycerol and found a marked increase of sensitiveness to light with methylene blue, phenosafranine, and scarlet. When a gelatine film containing 10 grams gelatine and 3 cc glycerol was stained with methylene blue, the color bleached completely in an hour's exposure to sunlight. With a film containing no glycerol, no change was observed in the same time. From his experiments von Hübl concludes that the light-sensitiveness of methylene blue is increased five hundred to a thousand fold by the addition of glycerol. No explanation is offered for this rather remarkable result.

Wurster<sup>3</sup> states that it is a well-known fact that glycerol makes oxygen active; but he gives no reference and we have not yet been able to find any authority for this statement. This is not of any great importance, however, because further consideration made it seem probable that the bleaching was not due to oxidation. Methylene blue can bleach by reduction or by oxidation. When the bleaching is done by reduction, the color comes back when the reduced dye is exposed to air. Now von Hübl found that the blue color reappeared when the prints were kept in the dark. This made it seem probable that sunlight caused glycerol to react with oxygen forming glyceric aldehyde—especially as it has already been noticed in Manila<sup>4</sup> that sunlight converts methyl alcohol to some extent into formaldehyde.

To test this point various concentrations of glycerol were placed in glass flasks and were exposed to a powerful arc lamp. Distinct evidence of the presence of an aldehyde was

<sup>1</sup> A paper read before the Eighth International Congress of Applied Chemistry in New York, September, 1912.

<sup>2</sup> Phot. Mittheilungen, 46, 253 (1909).

<sup>3</sup> Ber. chem. Ges. Berlin, 19, 3211 (1886).

<sup>4</sup> Freer: Philippine Jour. Sci., 5B; 8 (1910).

obtained by means of the fuchsine test. Glycerol, which had been acted on by light was found to bleach methylene blue, safranine, and Biebrich scarlet appreciably at 50° in the dark. In presence of sunlight the dye would react more rapidly. It was also shown that solutions of acetaldehyde bleach these three dyes in the dark, although slowly.

It was also found by von Hübl that an addition of arsenates and glycerol increased the sensitiveness of methylene blue. Since arsenates as such could only increase the light-sensitiveness of methylene blue by acting as an oxidizing agent, it is clear that there is an error of some sort here. Since no details are given, it is impossible to say whether von Hübl really used sodium arsenite instead of arsenate, or whether the reaction takes place faster in two stages, the aldehyde from the glycerol reducing the arsenate to arsenite, and the arsenite reducing the methylene blue. Whichever explanation one adopts, the arsenite is the important substance theoretically. It is interesting to note that Limmer<sup>1</sup> found a sensitizing effect due to what he calls arsenic trioxide, in the absence of glycerol. It seems probable that he was using sodium arsenite though he does not say so.

The general results of this paper are:

1. When glycerol and air are exposed to a bright light, an aldehyde is formed, presumably glyceric aldehyde.
2. Methylene blue, safranine, and Biebrich scarlet are bleached in the dark by acetaldehyde or by a solution of glycerol which has been exposed to light, the reaction taking place faster at higher temperatures.
3. The sensitizing action of glycerol on certain dyes, as discovered by von Hübl, is due to the formation of the aldehyde.
4. Dyes, which are not bleached by reduction, will not be sensitized in this way.
5. The alleged sensitizing action of arsenates in presence of glycerol is really due to arsenites.

*Cornell University*

<sup>1</sup> Zeit. angew. Chem., 1909, 1715.

## NEW BOOKS

**A Dictionary of Applied Chemistry.** By Sir Edward Thorpe. Vol. I. 16 × 24 cm; pp. 758. New York: Longmans, Green and Company. 1912. Price: \$13.50.—In the preface the author says:

"During the twenty-two years that have elapsed since the first volume of this work made its appearance, chemistry has advanced at a rate and to an extent altogether unprecedented in its history; or, indeed, in the history of any other science. This extraordinary growth has been accompanied by a no less remarkable increase in the variety and comprehensiveness of its applications to the arts and manufactures. Accordingly, in the attempt to make this re-issue reasonably adequate as a presentation of contemporary knowledge, both as regards the science and its applications, it has been found absolutely necessary to enlarge greatly the original scope of the book. All the articles in the former issue have been carefully revised and many have been wholly rewritten. In addition a large number of new and important subjects have had to be dealt with. The result is that this edition of the Dictionary of Applied Chemistry is practically a new work."

Among the interesting topics in this volume are: acetic acid; acetylene; acidimetry; adhesives; aerated waters; agate; alcohol; alizarin; aluminum; amines; ammonia; anaesthetics; analysis; animal charcoal; antimony; arsenic; assaying; azines; azo coloring matters; balance; barium; benzene; bismuth; bleaching; boron; brandy; Brazilwood; bread; brewing; butter; calcium; camphor; candles; carbohydrates; carbon; cellulose; cement; cereals; cerium metals and earths.

The book is very well done. To take but a single instance, there is an exceptionally good account of the effect of the mineral constituents of water on the appearance and quality of ale. A new edition of this standard work has been needed for a long time, and the chemical public will welcome the appearance of the second edition.

Wilder D. Bancroft

**Théorie de la Couche capillaire plane.** By Gerrit Bakker. 13 × 20 cm; 93 pp. Paris: Gauthier-Villars, 1911.—As the title implies the author discusses the capillary film for itself instead of writing a treatise on capillarity. He postulates that there is no discontinuous change at the surface between liquid and vapor, the apparent transition taking place through the capillary film. This may be true; but it is by no means obvious.

One of the interesting things in the book is the account of Kamerlingh Onnes' work disproving the experiments of de Heen and of Teichner in regard to densities at or near the critical temperature. A rather curious psychological point comes in here. The author is distinctly on the side of Onnes, but his own theory would have permitted him to account for the results of de Heen and of Teichner in case they had been true; consequently the author would like to have them true and he is inclined to think that they may be true. What it comes down to is that the author's theoretical considerations are of no value in enabling him to distinguish between two possible cases. While this does not prove that the author's point of view is wrong it shows it not to be universally helpful and reliable.

Wilder D. Bancroft

**Das latente Bild.** By H. Lüppo-Cramer. 15 × 22 cm; 61 pp. Halle: Wilhelm Knapp. 1911. Price: 3.60 Marks.—In the last ten years the author has written about two hundred papers dealing more or less definitely with the latent image. This little book is supposed to contain the condensed wisdom distilled from the numerous articles. The author believes that it is now possible to discard definitely some of the hypotheses in regard to the latent image. The author discusses the normal latent image from the point of view of physical changes and from the point of view of chemical changes. The second half of the book is devoted to solarization.

The author lays great stress upon the disintegration of the silver halides by Röntgen rays, light, etc.; but he does not make out a good case. It is only under special conditions that he can find any evidence of a disintegration and there is no attempt to show that the hypothesis is particularly helpful. No one can deny that radiations may and do cause a disintegration of silver salts; but it is very doubtful whether this disintegration is of any importance, practical or theoretical, except in one or two special cases.

The section on the chemical action of light is much better. While Lüppo-Cramer was not the first to consider the latent image as due to an adsorption, it is his work that has established this hypothesis and has shown its usefulness. The world moves slowly and there are still people who believe that the latent image is an allotropic modification or is a definite subhalide; but there is no longer any excuse for people believing such things. It is Lüppo-Cramer who has cleared away the mists.

Unfortunately, he has not been so clear-sighted in regard to solarization. He started with the unjustifiable premise that solarization could only be the result of the silver halide taking up halogen again and he has never been able to shake off this obsession. The natural result of this is that he finds himself puzzled by things which really present no difficulty. He cannot understand how one can develop an image by means of a uniform white light acting on a film soaked in a nitrite solution and yet he is dealing with a reducing agent, the strength of which varies with varying intensity of light.

There are people who do not like Lüppo-Cramer's papers, but the reviewer is not one of them. While he often finds himself unable to agree with Lüppo-Cramer's conclusions, he finds the papers always interesting and sometimes inspiring. The same thing can be said about the book. *Wilder D. Bancroft*

**Opere scelte.** By Amedeo Avogadro. 22 × 29 cm; pp. cxi + 491. Turin: Unione Tipografico-Editrice Torinese. 1911. Price: paper, 20 lire.—In 1811 Avogadro published the memoir containing the theorem which is now known as Avogadro's law. The hundredth anniversary of this event was celebrated in Italy last year and the Academy of Sciences at Turin has issued this sumptuous volume as part of the commemoration. The volume contains a long sketch of Avogadro's life by Guareschi, followed by thirteen of Avogadro's memoirs. The titles of these are: a method of determining the relative masses of the elementary molecules of substances and the proportions according to which they combine [the French and the Italian text are both given]; the relative masses of the molecules of simple substances; the specific heats of compound gases as related to the specific heats of the component gases; new thoughts

on the theory of definite ratios in compounds, and on the determination of the masses of the molecules of a substance; note on the necessity of distinguishing between the molecular weights and the chemical equivalents when determining the atomic volumes of substances; relations between the densities and constitutions of aeriform fluids; investigations of atomic volumes; reflections on the state of a substance, which does not conduct electricity, when placed as a film between two surfaces charged with opposite kinds of electricity; second memoir on electricity; ideas on acidity and alkalinity; thoughts on the electrochemical theory of Berzelius; memoir on the construction of a multiplying galvanometer and on its use in determining the order of the metals with reference to contact electricity; experiments on some doubtful points in regard to capillary action.

All chemists are familiar with Avogadro's law but very few of them know anything about Avogadro's work at first hand. All of us owe thanks to the Turin Academy for making these papers accessible. *Wilder D. Bancroft*

**Photochemische Versuchstechnik.** By Johannes Plotnikow. 16 X 24 cm; 360 pp. Leipzig: Akademische Verlagsgesellschaft. 1912. Price: 11 marks.—The subject is treated under five headings: sources of light; photo-thermostats; optical measuring instruments; photochemical lecture experiments; photochemical tables. Under sources of light the author discusses mercury arcs; metallic arcs and spark discharges; carbon arcs; colored flames; Nernst lamps; and Röntgen lamps. He is very explicit, p. 12, as to the dangers from ultra-violet light. The quartz mercury lamps, pp. 8, 72, give a group of very faint red lines, two bright yellow lines, a very bright green line, a weak blue-green line, and two fairly bright violet lines in addition to one very intense ultra-violet line and a number of lines of medium intensity in the ultra-violet. By adding a little cadmium, zinc and thallium to the mercury, p. 14, more lines are obtained in the blue, two lines in the green, and one in the orange. By means of suitable filters it is possible to leave only one group of lines in the visible spectrum and thus to get approximately monochromatic light. The following filters are recommended, pp. 20, 75: for red and orange, a solution of chrysoidine or of crystal red; for yellow, erythrosine and potassium bichromate; for green, bichromate and acid green; for bluish green, Guinea green and aesculine; for blue, acidified quinine sulphate and rhodamine; for violet, iodine in carbon tetrachloride and glass which absorbs ultra-violet; for ultra-violet, nitrosodimethylaniline and blue uviol glass. The author also gives, p. 56, a list of solutions which act fairly well as filters for white light.

The author has devised some uviol lamps, p. 9, which can be dipped into a solution so that it is illuminated from within. It seems to the reviewer that these would be very useful in cases of electrolysis because they could be put between the electrodes. The author has given a very good account of the effect of capacity and self-induction on the spark, p. 26; of the difference between soft and hard Roentgen tubes, p. 61; and of the general theory of the arc, p. 42.

In the second section of the book there is an excellent account of the special apparatus devised by the author for studying photochemical reactions at constant temperature and at constant intensity of light. These different pieces of apparatus can all be purchased of Fritz Koehler in Leipzig.

Of great interest is the list of reactions, p. 206, in which the equilibrium



is displaced either way, depending on the nature of the light used. Among the substances which are known to show this behavior are ozone, phosgene, hydrochloric acid, water, and sulphur trioxide. It is merely a question of time when many other substances will be added to this list. Of great interest also are the experiments of Berthelot and Gaudechon, p. 212, on the action of ultra-violet light on some carbon compounds.

The lecture experiments on luminescence, pp. 216-238, are very good. Among them are: the reddish orange luminescence due to the oxidation of pyrogallol, p. 218; the green luminescence of Wedekind's reaction, p. 219; and the green luminescence due to the oxidation of amarin. The author calls attention to the effect of temperature and speed on luminescence. On p. 226 the author gives the composition of a phosphorescent sulphide which phosphoresces in the ultra-violet, the active substance apparently being silver. On the next page a sulphide containing nickel is said to emit ultra-red light. The reviewer would have liked more explanation of the fact, p. 233, that iodine vapor fluoresces yellow-green under the action of the carbon arc, and reddish yellow when exposed to the light from a quartz mercury lamp. The author has devised a very ingenious apparatus, p. 236, for showing continuous triboluminescence.

The book is an admirable one and the author deserves much thanks for putting the experimental side of photochemistry on so excellent a basis.

Wilder D. Bancroft

**Handbuch der Mineralchemie.** By C. Doelter. Vol. 1, Part V: 18 × 25 cm; pp. 641-800. Dresden: Theodor Steinkopff, 1912. Price: paper, 6.50 marks.—This number deals with fused silicates and contains many interesting things. The author believes, p. 643, that a melting point may be lowered over 100° by grinding the material to a very fine powder. That seems excessive and one cannot help wishing that the experiments had been made with substances about which there is less question as to the melting point. It would be very instructive, for instance, if some one were to grind naphthalene into an isotropic glass at 0° or lower. On p. 668 there is a discussion of sintering. The author defines sintering as the beginning of melting and the point of sintering as the point at which melting is first visible. This is a perfectly legitimate definition, but the reviewer would have liked an expression of opinion as to whether a pure, crystallized, one-component system can sinter.

On page 679 the author follows Guertler in considering devitrification as a process which takes place at a definite temperature quite regardless of the rate of heating. The reviewer doubts whether there is any definite devitrification temperature in the sense that we have a definite inversion temperature. There is a welcome reference at this point to the conditions under which substances like glass can be drawn out into threads.

On p. 747 the author draws a parallel between the addition to a salt solution of a salt with a common ion and the addition to a melt of a salt with a common ion. He considers decrease of solubility as equivalent to decreased fusibility, which is legitimate enough; but he states that adding a salt with a common ion to a melt raises the freezing point which is not true unless the solid phase is a solid solution, and Nernst's solubility theorem does not apply to that case.

The reviewer objects strongly to differentiating molten alloys from fused



salts, p. 791, because one conducts metallically and the other electrolytically. The phase rule relations are quite independent of this. It is also not correct to state, p. 702, that the phase rule does not hold in cases where the components can react one with another.

This number contains extended discussions: of the conditions under which silicates crystallize; of the specific heats of silicates; and of the electrolytic dissociation of silicates. The last portion of the number is taken up with data as to fusion curves of mixed silicates. The author also gives the melting points of a number of pure silicates as determined in several different ways. As was perhaps to be expected, the results obtained by different methods and by different laboratories do not agree any too well.

*Wilder D. Bancroft*

*Die Nephritis.* By Martin H. Fischer. Translated by Hans Handorsky and Wolfgang Ostwald. 16 X 24 cm; pp. 151. Dresden: Theodor Steinkopff, 1912. Price: paper, 5 marks; bound, 6 marks.—The German edition was apparently issued practically simultaneously with the American one. As the latter has already been reviewed (16, 424), a reference is all that is now necessary.

*Wilder D. Bancroft*

*Laboratory Problems in Physics.* By Franklin T. Jones and Robert Tatnall. 12 X 20 cm; 81 pp. New York: The MacMillan Company, 1912. Price: \$0.50 net.—This little book is intended for an elementary course in physics and there is very little in it which has to do with chemistry as ordinarily defined. On p. 61, the student is told to dip copper plates into a copper sulphate solution and to allow a current of unknown amount to flow for some time, then noting the change in the appearance of the two plates. He is told that pure copper only is deposited on the cathode and is asked how this process could be applied to the refining of copper. Of course the experiment does not show anything as to the possibility of refining copper electrolytically. It is a good experiment to show the possibility of electroplating with copper; but the refining depends on the decomposition voltages and on the formation of anode slimes.

*Wilder D. Bancroft*

THE ELECTRICAL CONDUCTANCE OF SOLUTIONS IN  
METHYLAMINE AND ETHYLAMINE; THE FLUID-  
ITY OF AMMONIA, METHYLAMINE AND SUL-  
PHUR DIOXIDE AND THE FLUIDITY OF  
CERTAIN SOLUTIONS IN THESE  
SOLVENTS

BY FRED F. FITZGERALD

PART I.—CONDUCTANCE OF SOLUTIONS IN METHYLAMINE  
AND ETHYLAMINE

Introduction

An unexpected behavior of methylamine solutions was observed by Gibbs,<sup>1</sup> who measured the electrical conductance of silver nitrate and potassium iodide in this solvent. He found the molecular conductance of silver nitrate, beginning with concentrated solutions, first to rise, with increasing dilution, to a maximum value, thence to fall to a minimum, thence to rise again presumably toward a final maximum after the familiar manner of salts in aqueous solution.

Following Gibbs' observation the plan was inaugurated in this laboratory of measuring the electrical conductance of concentrated solutions in a number of electrolytic solvents in order to determine the extent to which the behavior observed by Gibbs is followed by solutions in other solvents.

Returning to a study of the electrical conductance of liquid ammonia solutions Franklin<sup>2</sup> found that although the phenomenon observed by Gibbs does not recur in the case of all liquid ammonia solutions, still, the characteristic trend of the molecular conductance curve was found to mark the behavior of certain salts in this solvent.

Certain results recorded by Walden and Centnerzwer in their paper on sulphur dioxide as a solvent<sup>3</sup> led Franklin to

<sup>1</sup> Franklin and Gibbs: Jour. Am. Chem. Soc., 29, 1389 (1907).

<sup>2</sup> Zeit. phys. Chem., 69, 272 (1909).

<sup>3</sup> Bull. Acad. Imp. Sci. St. Pétersbourg, [5] 15, 17 (1901); Zeit. phys. Chem., 39, 513 (1902); Zeit. anorg. Chem., 30, 145 (1902).

expect a similar behavior on the part of solutions in this solvent. Reference to the record<sup>1</sup> of his investigations will show that this surmise was justified. These investigations upon sulphur dioxide solutions are of especial interest in that they show the complete trend of these peculiar conductance curves from the most concentrated realizable solutions up to and including those of the highest dilution as measured by Dutoit and Gyr.<sup>2</sup> With continued dilution, beginning with highly concentrated solutions, the molecular conductance first rises rapidly to a maximum then falls to a minimum, thence rises, at first rapidly and then at a diminishing rate until the final maximum characteristic of an aqueous solution is reached. Neither in ammonia nor in any other solvents which show these maxima and minima, had any of the solutions which exhibit the first maximum and the minimum theretofore been carried to sufficiently high dilutions to establish the second maximum experimentally.

Conductance maxima and minima similar to those brought to light in this laboratory have been found to characterize certain other solutions.

Lewis and Wheeler<sup>3</sup> in their investigations upon liquid iodine as an electrolytic solvent found that potassium iodide solutions show a molecular conductance which with increasing dilution rises to a conspicuous maximum and then declines, showing distinctly a minimum, which latter, however, in view of the uncertainty attaching to measurements on the more dilute solutions, was not emphasized by the authors.

A distinct maximum and minimum has been found by Archibald<sup>4</sup> to characterize the molecular conductance curve of salicylic acid in liquid hydrochloric acid, and recently McBain and Taylor<sup>5</sup> and Bowden<sup>6</sup> have observed the same be-

<sup>1</sup> Jour. Phys. Chem., 15, 675 (1911).

<sup>2</sup> Jour. Chim. Phys., 7, 189 (1909).

<sup>3</sup> Proc. Am. Acad., 41, 419 (1906).

<sup>4</sup> Jour. Am. Chem. Soc., 29, 1429 (1907).

<sup>5</sup> Zeit. phys. Chem., 74, 206 (1911).

<sup>6</sup> Jour. Chem. Soc., 99, 194 (1911).

havior on the part of aqueous solutions of sodium palmitate and sodium stearate.

A considerable number of investigations may be cited in which the observed anomalous behavior on the part of the molecular conductance curve may be explained by assuming that in each case the descending portions only of the complete curve have been observed. For example, diminishing molecular conductance with increasing dilution is shown in the early measurements of Kablukoff<sup>1</sup> on solutions of hydrochloric acid in ether and amyl alcohol; in the measurements of Plotnikoff<sup>2</sup> on solutions of antimony bromide and phosphorus pentabromide in bromine; of Sackur<sup>3</sup> on solutions of hydrochloric acid in cineol; of Franklin and Kraus<sup>4</sup> on solutions of certain metallic cyanides in liquid ammonia; of Jones and Carroll<sup>5</sup> on hydrochloric acid in mixtures of methyl alcohol and water; of MacIntosh and Archibald<sup>6</sup> and of Archibald<sup>7</sup> on certain solutions of liquefied halogen acids; and of Kahlenberg and Ruhoff<sup>8</sup> on cadmium iodide and ferric chloride in amylamine.

In other instances there has been observed a rise to a maximum followed by a continuous depression of the molecular conductance with increasing dilution. Such behavior was found by Franklin and Kraus<sup>9</sup> to characterize certain metallic cyanides in solution in liquid ammonia; and by Kahlenberg and Ruhoff<sup>10</sup> to be characteristic of solutions of silver nitrate in amylamine; Walden<sup>11</sup> has observed a similar behavior on the part of solutions of tetraethylammonium iodide in

<sup>1</sup> *Zeit. phys. Chem.*, 4, 492 (1889).

<sup>2</sup> Plotnikoff: *Ibid.*, 48, 220 (1904).

<sup>3</sup> *Ber. chem. Ges. Berlin*, 35, 1242 (1902).

<sup>4</sup> *Jour. Chem. Soc.*, 27, 191 (1905).

<sup>5</sup> *Carnegie Institution of Washington Pub.*, 80, 51 (1907).

<sup>6</sup> *Jour. Am. Chem. Soc.*, 29, 655, 1416 (1907).

<sup>7</sup> *Phil. Trans.*, 205A, 120 (1906).

<sup>8</sup> *Jour. Phys. Chem.*, 7, 254 (1903).

<sup>9</sup> *Loc. cit.*

<sup>10</sup> *Jour. Phys. Chem.*, 7, 254 (1903).

<sup>11</sup> *Zeit. phys. Chem.*, 54, 131 (1906).

acetaldehyde and acetic acid, and Shinn<sup>1</sup> on the part of solutions of lithium chloride in ethylamine. In all these measurements the assumption seems justified that the conditions happened to permit the realization of the first maximum only of the complete conductance curve.

In the investigation of still other solutions the minimum only of the complete curve has been observed as will be seen, for example, by reference to the measurements of the conductance of zinc cyanide in liquid ammonia by Franklin and Kraus<sup>2</sup> and to the work of Archibald<sup>3</sup> on a considerable number of solutions in liquid hydrochloric acid and liquid hydrobromic acid.

With the object in view of adding to the data necessary for elucidation of the mechanism of the conduction of concentrated solutions, the writer has undertaken the measurement of the electrical conductance of solutions in methylamine and ethylamine through as wide a range of concentrations and temperatures as possible under available working conditions. The writer feels rather apologetic for the meagerness of results obtained but pleads in extenuation the experimental difficulties attached to working with solvents of low boiling points; the major portion of the time available for the work being consumed in acquiring the necessary manipulative skill.

<sup>1</sup> Jour. Phys. Chem., 11, 537 (1907).

<sup>2</sup> Loc. cit.

<sup>3</sup> Jour. Am. Chem. Soc., 29, 665, 1416 (1907). It is interesting to note in connection with the work of Archibald that just as phosphine and stibine are successively poorer ionizing solvents than ammonia and as hydrogen sulphide is likewise a much poorer ionizing solvent than water, so hydrobromic acid appears a poorer ionizing solvent than hydrochloric acid which in turn must be a poorer ionizing solvent than hydrofluoric acid. Hydrofluoric acid being the hydride of the typical member of the eighth group of the periodic system ought to be a conspicuously better electrolytic solvent than the succeeding members of the group, just as water and ammonia greatly excel the hydrides of the other members of the seventh and sixth groups respectively. The conspicuous power of hydrofluoric acid as a solvent for certain salts and the fact that the isolation of fluorine was made possible to Moissan by the good conducting power of a solution of potassium fluoride in liquid hydrofluoric acid are facts which make such a view plausible.

### Apparatus and Method of Manipulation

The apparatus which was used for the measurement of the conductance of solutions in methyl and ethylamine was essentially the same as that used by Franklin<sup>1</sup> and Franklin and Kraus,<sup>2</sup> except that the conductance cell was made much smaller in order to conserve the expensive solvents used.

*The Thermostat.*—The conductance cell was kept at a constant temperature in a bath of liquid ammonia, or in a mixture of ammonia and water, contained in a Dewar cylinder A, Figure 1. Tube M is for introducing liquid ammonia into the bath. Tube N is for emptying, partially or completely, the bath after each series of measurements. The tube V is for the escape of ammonia gas. A thermometer which has been tested at the Reichsanstalt is shown at B. The temperature was adjusted by the use of a vacuum pump, attached to V in the same manner as described by Franklin,<sup>3</sup> except that it was not regulated automatically.

*The Conductance Cell.*—The conductance cell is provided with three electrodes, two lower ones, XX, at the bottom of the cell for use with solutions of high resistance, and a smaller one W above, which is used in connection with one of the lower electrodes for good conducting solutions. These three electrodes are connected with the measuring apparatus by means of heavy copper wires passing down through the tubes, X' X', and a third, not shown in the figure; contact with the electrodes being obtained through mercury in the

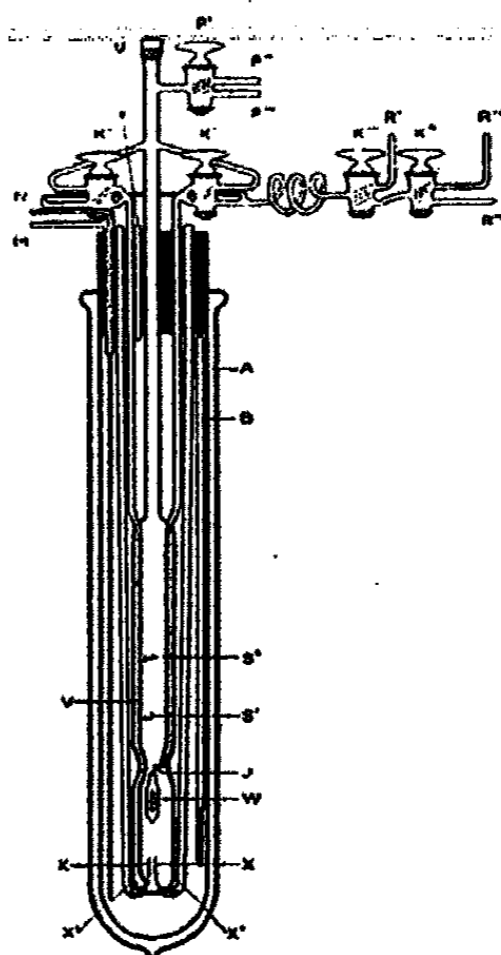

Fig. 1

<sup>1</sup> Zeit. phys. Chem., 69, 272 (1909).

<sup>2</sup> Am. Chem. Jour., 23, 277 (1900).

<sup>3</sup> Loc. cit.

bottom of these tubes. The resistance between the upper electrode and one of the lower set of electrodes is increased by enclosing the upper electrode in a glass cylinder open at each end as shown in the figure. The cell is constricted at J to permit more accurate setting at that point.

*Manipulation.*<sup>1</sup>—The details of a series of measurements are as follows: The bath A is first filled with liquid ammonia. The cell is then thoroughly washed by use of the solvent. To this end the amine is condensed in the cell through R', K'', K', and is then forced out by application of hydrogen pressure on the surface of the liquid, setting stopcocks K', K'', and K<sup>iv</sup>, to deliver through R'' to a waste vessel. This operation is repeated until the cell is absolutely clean.

A weighed quantity of solute is now introduced through the neck of the cell U, a small long-stemmed funnel carrying the solute well toward the lower end of the cell. The tubulure is then sealed off with a small gas flame as it was found that the methylamine decomposes any cork stopper very quickly at the higher temperatures used. Solvent is then distilled into the cell through R', K'', and K' until the pointer J is slightly more than covered. After thorough stirring to ensure homogeneity, the surface of the solution is adjusted to pointer J. This stirring and adjustment is accomplished by forcing a current of pure, dry hydrogen, brought from the generator by way of R'', K<sup>iv</sup>, K'', K', through the solution. During these operations the stopcock K' and the gas exit P'' are opened or closed as exigencies of the operations require. After temperature equilibrium has been established, the resistance of the solution is measured, the method of Kohlrausch with alternating current and telephone being used. This resistance is for a temperature of  $-33.5^{\circ}$ . The temperature of

<sup>1</sup> For more complete descriptions of apparatus used in the investigation of liquids of low boiling points the reader is referred to earlier papers from this laboratory. *Am. Chem. Jour.*, 20, 836 (1898); 23, 277 (1900); 24, 83 (1900); *Jour. Am. Chem. Soc.*, 26, 499 (1904); 27, 830 (1905); 27, 851 (1905); 28, 1395 (1906); 29, 656 (1907); 29, 1389 (1907); *Jour. Phys. Chem.*, 11, 553 (1907); 11, 559 (1907); 15, 675 (1911); *Jour. Am. Chem. Soc.*, 29, 1693 (1907); *Zeit. phys. Chem.*, 69, 272 (1909).

the bath is then raised to  $-15^{\circ}$  by forcing out part of the liquid ammonia from the Dewar thermostat A, and replacing it with a solution of ammonia in water until the temperature is slightly above  $-15^{\circ}$ . The temperature is then adjusted to  $-15^{\circ}$  by use of the vacuum pump. The level of the solution in the cell is then readjusted to pointer J, and the conductance measured. The operations thus described are repeated for the temperatures  $0^{\circ}$  and  $+15^{\circ}$ . After the conductance at  $+15^{\circ}$  has been measured the temperature is lowered to  $-33.5^{\circ}$ , the surface of the solution is adjusted to pointer J and the resistance again measured. The purity of the solvent and the accuracy of the operations are thus checked. For the next dilution the solvent is distilled into the apparatus until the surface of the solution stands slightly above pointer S', when the series of operations described above is repeated.

After the measurements at the dilution corresponding to pointer S' have been performed it is necessary to remove a known portion of the solution from the cell. To do this, hydrogen pressure is turned on to the surface of the solution through stopcock P''; P' and K'', K''' and K<sup>iv</sup>, being set to deliver liquid through R''' into the waste flask. As the level of the liquid in the cell approaches pointer J the rate of emptying is slowed down by partly closing stopcock K''. The delivery of liquid stops automatically when the surface of the liquid reaches the point of the delivery tube J, leaving a known fraction of the solution in the cell. The stopcock P' is then momentarily opened through P''' to relieve the cell of the hydrogen pressure. After the removal of this portion of the solution the conductance of the solution at  $-33.5^{\circ}$  is again measured to make sure that the concentration has not altered during manipulation. The series of operations thus described are then repeated in the manner described above until the desired number of dilutions has been made. The tubes connecting stopcocks K' and K'' with the neck of the conductance cell are for the purpose of equalizing the pressure in all parts of the cell.

When the dilutions have been carried as far as desired,



the cell is completely emptied by application of hydrogen pressure to the surface of the liquid through P", and setting K', K'', K<sup>IV</sup>, R'', to deliver the solution into the waste vessel. The cell is washed clean in the manner described above, the sealed end of the U tube is cut off and a new neck sealed in its place when the apparatus is ready for beginning a new series of measurements.

*Cell Constants.*—The volumes to marks J, S' and S'' were 4.95, 7.28 and 9.88 cubic centimeters, respectively. The resistance capacity for the high resistance pair of electrodes was 16.33 Kohlrausch units, and for the low resistance pair 0.1137 Kohlrausch units.

*The Solvents.*—The methylamine used was partly a Kahlbaum preparation, partly prepared in this laboratory by Mr. R. W. Poindexter, to whom the writer hereby acknowledges his obligations. The amine was made on rather a large scale by the method of Hofmann, chlorinated lime being substituted for the more expensive bromine and potassium hydroxide. The crude product was purified by fractional distillation, followed by treatment with mercuric oxide and redistillation. Between 400 and 500 grams of pure solvent were prepared.

The attempt was made to use methylamine and ethylamine prepared by Schuchardt. The specimens were found to contain ammonia and other impurities which rendered their use impossible.

#### The Conductance of Methylamine Solutions

The fact that methylamine is an electrolytic solvent was first noted by Franklin and Kraus<sup>1</sup> who observed its power as a solvent and made approximate measurements of the conductance of a tenth-normal solution of potassium iodide from  $-63^{\circ}$  up to  $+150^{\circ}$ . Gibbs later took up the study of methylamine as a solvent not only for inorganic salts but also

<sup>1</sup> Am. Chem. Jour., 24, 90 (1900).

for organic compounds of the most varied types.<sup>1</sup> Gibbs found that methylamine is a remarkably good solvent for a large variety of compounds, especially for compounds of carbon. He also noted that many of these solutions are conductors of electricity. Following upon this work, Gibbs<sup>2</sup> undertook quantitative measurements of the electrical conductance of methylamine solutions and discovered the then unique behavior of solutions of silver nitrate. Unfortunately, however, his work was suddenly terminated by the great San Francisco earthquake of April, 1906. Following upon the work of Gibbs, Mr. D. H. Hoagland took up the investigation of the electrical conductance of methylamine solutions but was forced by circumstances to abandon the work after making a few measurements. His results, which have not hitherto been published, are included in the data given below. The writer has undertaken a continuation of the work of Gibbs and Hoagland, but instead of extending his measurements to a large number of solutes, has chosen two solutes only and has measured their conductance through as wide range of dilution and temperature as the means at his disposal would permit.

In the tables which follow are given in the first column the dilutions in liters per gram molecule, in columns 2, 3, 4 and 5, the molecular conductances in Kohlrausch units at the respective temperatures indicated. Data given under I, II, III, etc., represent independent series of measurements.

*Silver Nitrate.*—This salt is extremely soluble in methylamine, a solution containing 69.2 grams to 100 cc. of the solution being yet unsaturated at temperatures between  $-33^{\circ}$  and  $+15^{\circ}$ . The presence of the least trace of moisture causes the separation of a black precipitate. For some reason which must remain unexplained the results here recorded for the conductance of silver nitrate solutions at  $0^{\circ}$  are not in as close agreement with those of Gibbs as could be desired.

<sup>1</sup> Jour. Am. Chem. Soc., 28, 1395 (1906).

<sup>2</sup> Ibid., 29, 1381 (1907).

A				
$\kappa \cdot 10^{-3}$	$-33.5^\circ$	$-15^\circ$	$0^\circ$	$+15^\circ$
I				
0.2456	3.237	6.180	9.262	13.05
0.4790	14.33	20.56	25.67	30.8
0.9348	22.61	28.92	34.15	38.77
II				
30.54	18.52	20.28	19.90	18.68
59.58	20.12	21.10	19.97	18.89
116.2	23.96	25.05	23.86	21.54
226.9	28.73	29.56	28.62	26.11
III				
5.449	21.80	25.18	26.81	27.41
10.63	20.04	22.19	22.74	22.19
20.74	19.08	20.44	20.44	19.55
40.48	19.56	20.23	20.03	18.41
IV				
0.2806	4.945	8.67	12.36	16.52
0.5475	16.13	22.17	27.51	32.29
1.069	23.01	29.38	34.13	38.56
2.084	24.32	29.48	32.97	34.95
V				
139.7	25.34	26.37	25.29	23.02
272.7	30.66	31.65	30.29	27.62
532.0	37.96	39.51	37.96	34.35
1038.0	46.88	49.57	48.21	44.14

*Potassium Iodide.*—The conductance of potassium iodide in methylamine at  $0^\circ$  has been studied by Gibbs;<sup>1</sup> his work was, however, cut short by the great earthquake before measurements were carried to concentrated solutions. The salt used by the writer was from a specimen by J. T. Baker, dried by gentle ignition. It is to be noted that there is a discrepancy between the results obtained by the author, on the one hand, as against the results of Gibbs and Hoagland on the other which the writer is at a loss to explain. In view, however, of the better control of the conditions which experience has permitted the writer to achieve it is

<sup>1</sup> Loc. cit.

believed that the later results are deserving of greater confidence.

$\varphi \cdot 10^{-3}$	$\Lambda$			
	$-33.5^\circ$	$-15^\circ$	$0^\circ$	$+15^\circ$
	I			
0.6094	31.12	38.17	42.90	46.49
1.190	32.97	38.52	41.74	43.96
2.320	28.49	31.45	33.90	33.39
4.527	21.68	23.45	23.45	22.93
8.833	17.40	17.96	17.26	15.80
17.24	15.06	14.98	13.91	12.57
33.62	14.64	14.18	13.04	11.44
65.61	15.91	15.35	13.88	11.92
	II			
28.21	14.63	14.10	13.25	11.56
55.04	15.49	14.84	13.62	11.78
107.4	17.72	17.27	15.44	13.43
209.5	21.77	21.26	19.30	16.52
408.9	27.79	27.24	24.94	21.38
797.9	35.63	35.15	32.32	27.91
1557.0	45.86	45.86	42.86	37.55
3038.0	58.73	59.67	56.62	49.83
5927.0	74.53	77.00	74.00	66.40

The following data are the result of measurements at  $0^\circ$  made in this laboratory in the fall of 1907 by Hoagland.

*Potassium Iodide*.—Five series of measurements were made as follows:

$\varphi/1000$	$\Lambda$	$\varphi/1000$	$\Lambda$
I		IV	
1.20	40.6	—	—
2.23	33.3	2.00	34.6
II		V	
0.59	39.1	4.57	23.1
1.10	40.4	8.50	17.1
—	—	15.7	13.5
III		—	—
0.92	40.9	—	—
1.71	35.2	—	—

*Lithium Nitrate.*—The strongest solution of this salt crystallized to a solid mass after exposure for a short time at a temperature of zero degrees. It is much more soluble at higher temperatures. Four separate series of measurements were made as follows:

$\varphi/1000$	$\lambda$	$\varphi/1000$	$\lambda$
I		III	
0.278	10.3	1.17	20.6
0.513	15.6	2.18	14.8
II		IV	
0.665	19.8	8.77	11.4
1.22	20.8	16.2	9.59
—	—	29.9	8.83
—	—	55.3	9.35
III			
1.17	20.6	—	—

*Lithium Chloride.*—This salt is less soluble than lithium nitrate. A solution containing 2 millimols per cubic centimeter is approximately saturated at zero degrees. But one series of measurements was made:

$\varphi/1000$	$\lambda$	$\varphi/1000$	$\lambda$
0.493	9.51	5.74	6.67
0.91	12.20	10.59	5.20
1.68	10.47	19.55	4.73
3.11	7.98	—	—

*Sodium Nitrate.*—One series of measurements was made:

$\varphi/1000$	$\lambda$	$\varphi/1000$	$\lambda$
1.488	12.02	5.95	5.32
2.149	9.43	11.91	3.90
2.98	7.76	23.81	3.53
4.30	6.46	—	—

*Mercuric Iodide.*—A laboratory specimen of this salt, which received no other treatment than thorough drying, dissolved abundantly to a colorless but somewhat milky solution. On dilution the solution cleared up. But a single series of measurements was made:

$\varphi/1000$	$A$	$\varphi/1000$	$A$
0.797	3.01	2.85	1.38
1.046	2.82	4.18	1.02
1.537	2.31	5.36	0.86
2.22	1.72	7.88	0.67

*Metadinitrobenzene.*—This substance, when freshly dissolved, forms a permanganate colored solution which changes gradually to a deep blue. Dilute solutions are red. As observed by Franklin and Kraus<sup>1</sup> for solutions in liquid ammonia, a freshly prepared solution of metadinitrobenzene in methylamine shows a gradual increase in conductance on standing. After some ten or fifteen minutes the conductance becomes constant. After each dilution the conductance increases for some time before becoming constant. Three series of measurements were made:

$\varphi/1000$	$A$	$\varphi/1000$	$A$
I		III	
1.24	28.93	26.7	20.6
2.31	30.47	39.2	21.3
4.26	25.4	54.3	22.7
7.86	22.0	78.3	24.1
14.2	20.4	108.5	26.1
26.8	20.3	156.7	28.5
49.5	22.0	217.0	31.0
—	—	313.0	35.0
—	—	434.0	38.8
II			
7.93	23.6	—	—

<sup>1</sup> Am. Chem. Jour., 23, 301 (1900).

### The Electrical Conductance of Ethylamine Solutions

The conductance of solutions of silver nitrate, ethylammonium chloride and lithium chloride were made at four temperatures,  $-33.5^\circ$ ,  $-15^\circ$ ,  $0^\circ$  and  $+15^\circ$ , and through as wide a range of concentration as conditions under which the work was carried on would permit. The following tables contain the data,  $\varphi 10^{-3}$  expressing the dilution in liters per gram molecule and  $\Lambda$  the molecular conductance in Kohlrausch units.

*Silver Nitrate.*—This salt dissolves readily in ethylamine producing a clear, colorless solution, provided the salt and solvent are quite dry. The merest trace of moisture gives a black precipitate. The solution very readily undergoes reduction, "silvering" the apparatus, especially when acted upon by direct sunlight. The conductance of ethylamine solutions of silver nitrate at  $0^\circ$  has been measured by Frederick Shinn.<sup>1</sup> For reference his data are plotted in the figure with those given herewith.

$\varphi \cdot 10^{-3}$	$\Lambda$			
	$33.5^\circ$	$-15^\circ$	$0^\circ$	$+15^\circ$
	I			
0.9928	5.67	8.44	10.55	12.52
1.981	5.820	7.625	9.082	10.25
3.953	4.320	5.400	6.141	6.719
7.886	2.683	3.181	3.454	3.690
15.73	1.677	1.818	1.939	1.939
31.39	1.212	1.277	1.285	1.188
62.65	1.038	1.055	1.010	0.9056
125.0	1.041	1.041	0.9658	0.8535
	II			
0.4083	2.135	3.989	5.824	8.072
0.7968	5.310	7.753	10.09	12.11

*Lithium Chloride.*—Measurements on the conductance of lithium chloride in ethylamine have been made by Fred-

<sup>1</sup> Jour. Phys. Chem., 11, 537 (1907).

erick Shinn.<sup>1</sup> For reference his data are plotted on the same plate with the writer's data.

$\phi \cdot 10^{-3}$	$t$			
	$-33.5^{\circ}$	$-15^{\circ}$	$0^{\circ}$	$+15^{\circ}$
I				
0.4215	— <sup>2</sup>	— <sup>2</sup>	1.586	2.080
0.8224	— <sup>2</sup>	2.001	2.447	2.661
1.604	1.279	1.763	1.911	1.835
3.131	0.8484	0.9915	0.976	0.8052
II				
2.523	1.032	1.275	1.293	1.105
4.923	0.561	0.5933	0.5294	0.4048
9.607	0.3001	0.2923	0.2387	0.1722
14.89	0.1564	0.1400	0.1093	0.08168

*Ethylammonium Chloride.*—A specimen of Kahlbaum was used which received further treatment beyond thorough drying.

$\phi \cdot 10^{-3}$	$t$			
	$-33.5^{\circ}$	$-15^{\circ}$	$0^{\circ}$	$+15^{\circ}$
I				
0.1666	— <sup>3</sup>	0.7197	1.450	2.440
0.3253	2.293	3.851	5.242	6.616
0.6346	—	5.090	5.820	6.406
II				
0.7676	3.692	4.675	5.294	5.630
1.497	2.606	2.921	2.992	2.886
2.922	1.285	1.261	1.181	1.064
5.702	0.5711	0.5359	0.4640	0.4054
11.13	0.3099	0.2804	0.2441	0.2001
21.71	0.2316	0.2122	0.1824	0.1525
42.36	0.2163	0.1872	0.1638	0.1371
III				
0.2368	— <sup>3</sup>	2.345	3.597	5.050
0.4619	3.388	4.869	5.993	6.968
0.9014	3.535	4.325	4.696	4.986

<sup>1</sup> Loc. cit.

<sup>2</sup> At these temperatures not all the salt present in the cell was in solution.

<sup>3</sup> At  $-33.5^{\circ}$  a portion of the solute separated from the solution.



*Discussion of Results.*—The data given in the above tables are plotted in Figures 2-6, in which ordinates represent molec-

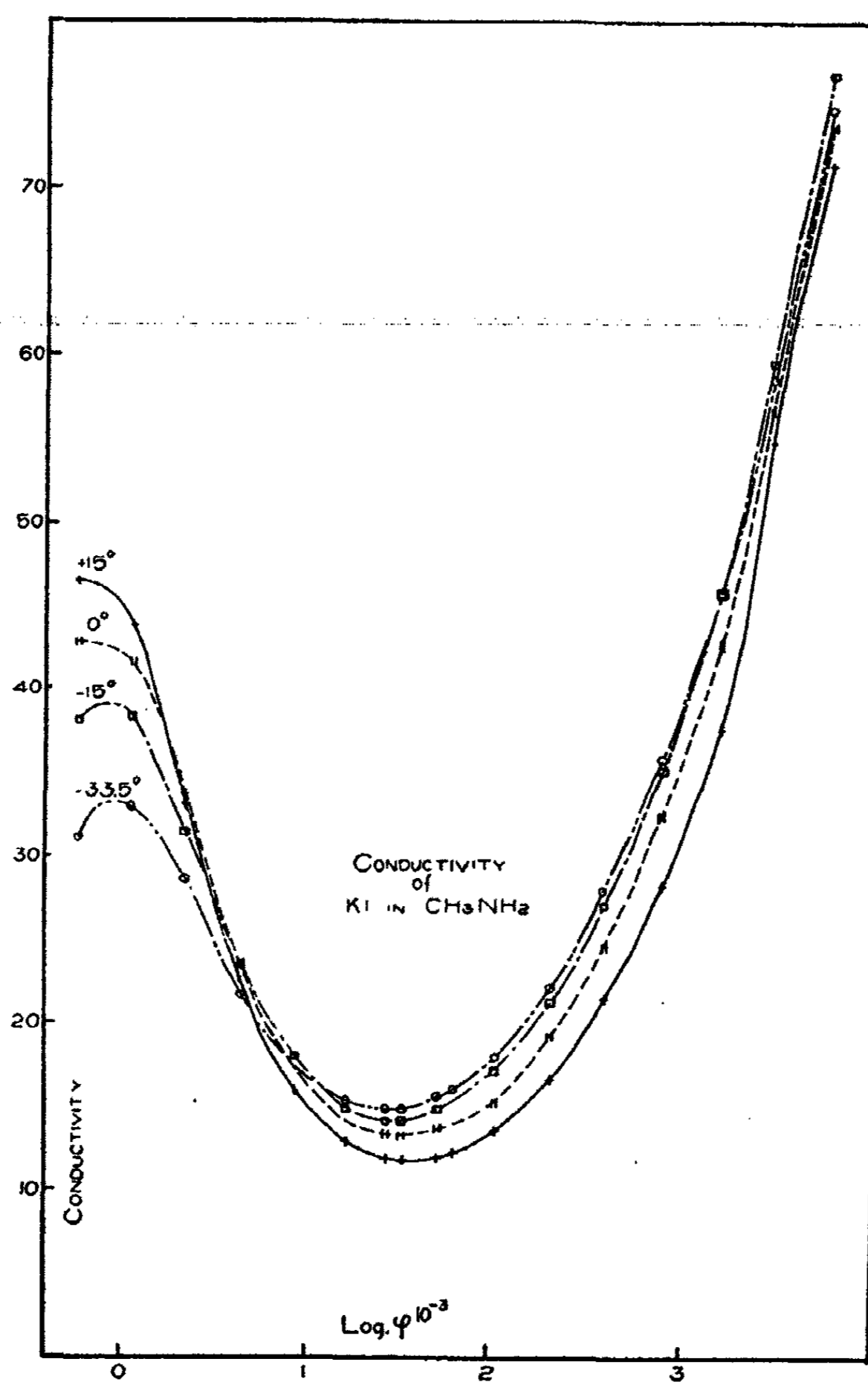

Fig. 2

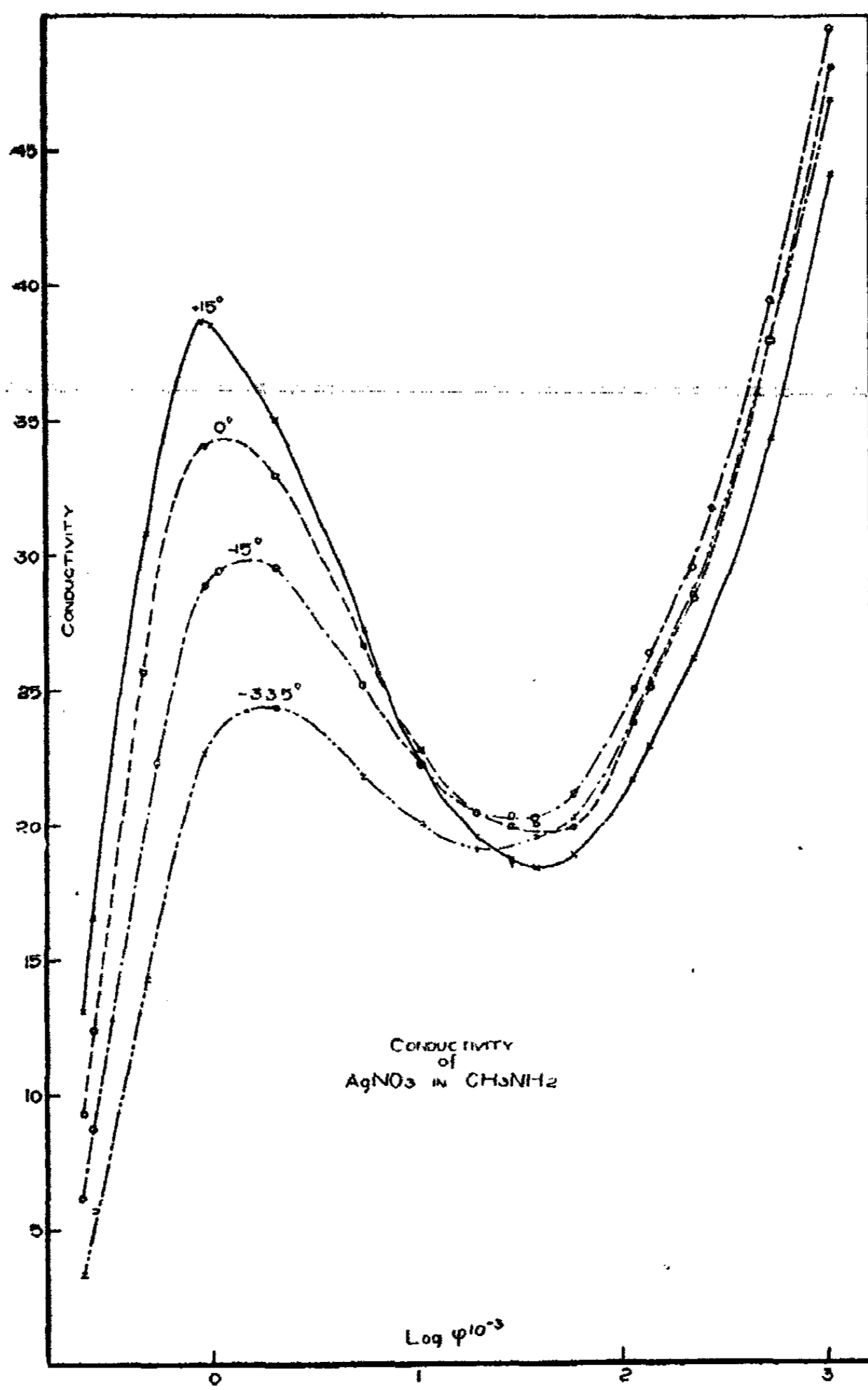

Fig. 3

ular conductances and abscissas the logarithms of the dilutions. It seems worth while to call attention to a few points of interest in connection with these measurements.

In the first place it is to be noted that the molecular conductance of the solutes studied, both in methylamine and ethylamine, show the maximum observed by Gibbs for silver nitrate in methylamine and by Franklin for certain

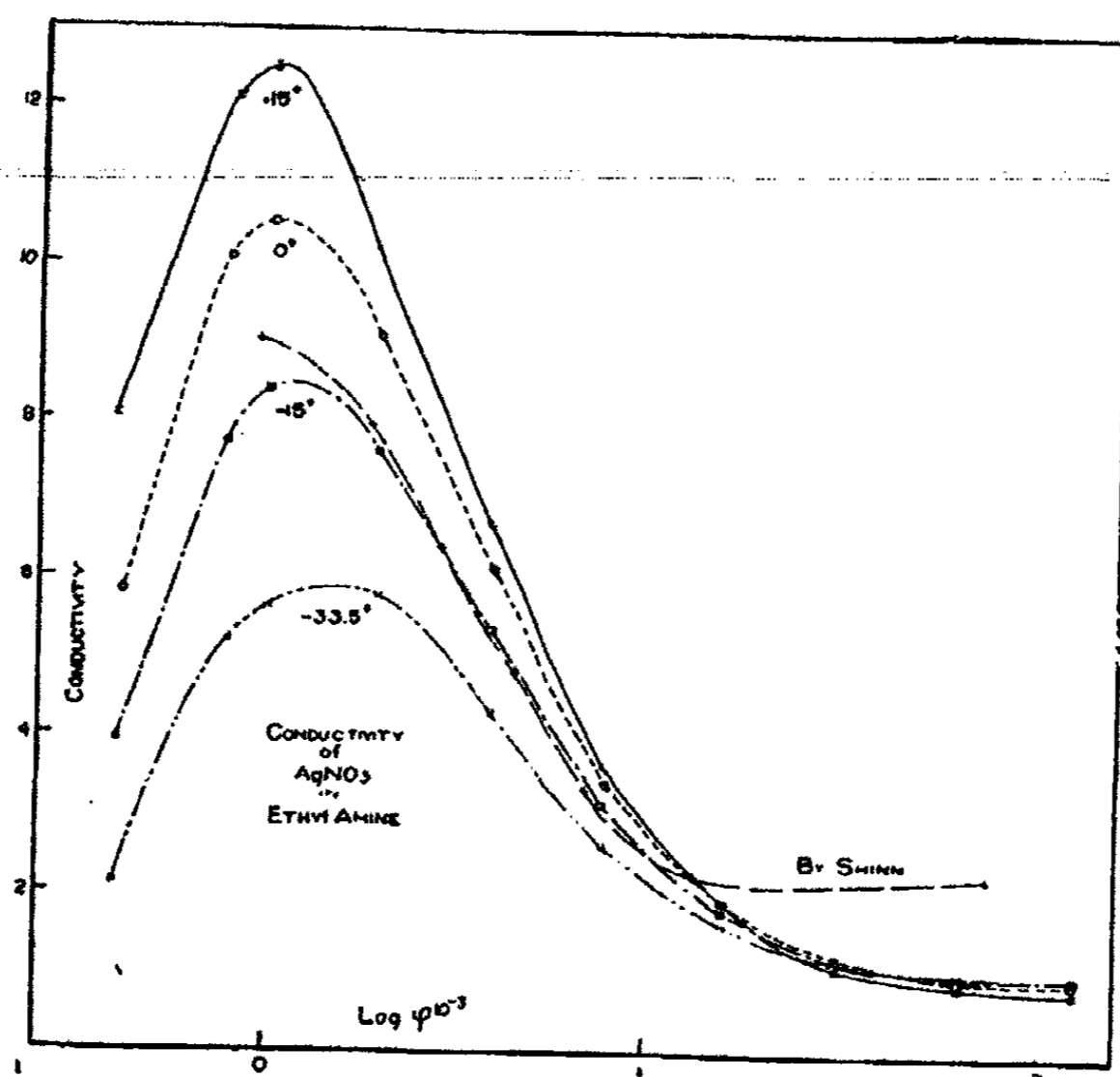

Fig. 4

solutions in ammonia and sulphur dioxide. In the case of methylamine solutions the maximum is followed by a minimum, but a final maximum which presumably should be reached at high dilution could not be realized because of the extreme dilution to which measurements would have to be carried to accomplish complete ionization in this solvent. In the case of solutions in the poorer ionizing solvent, ethylamine, the measurements could not be carried to sufficiently

high dilutions to demonstrate with certainty the existence of a minimum of molecular conductance. The curves representing molecular conductances of solutions in this solvent are seen to approach the axis of abscissas with no indications,

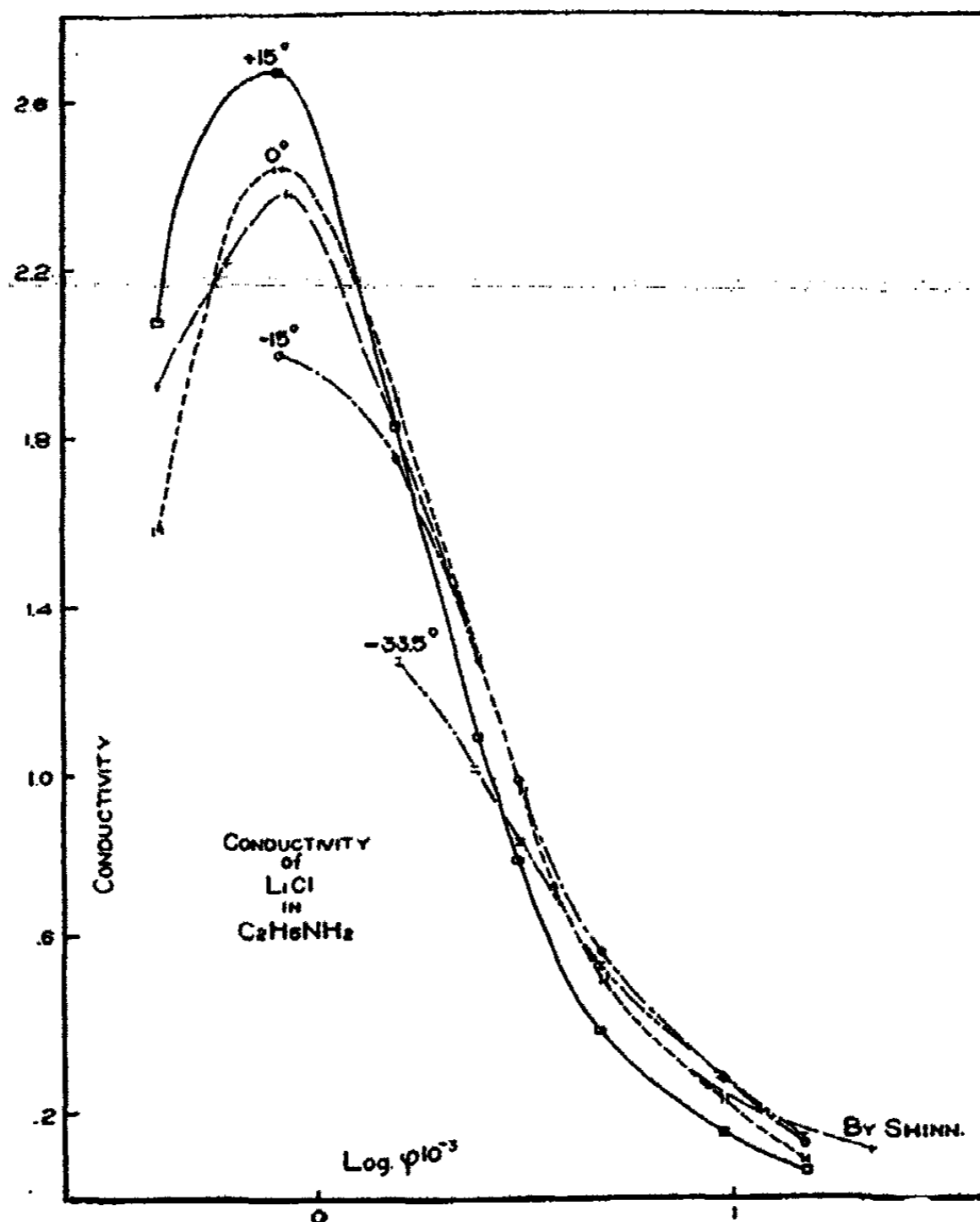

Fig. 5

excepting in the case of silver nitrate, of a rise with continued dilution.

In the second place, it will be noticed, as was found to be the case by Franklin for solutions in sulphur dioxide<sup>1</sup> that

<sup>1</sup> Jour. Phys. Chem., 15, 675 (1911).

the conductance temperature coefficients for concentrated solutions are positive and that as the solutions are diluted change sign after the manner recorded for solutions in sulphur dioxide. For methylamine solutions the measurements of molecular conductance at the higher dilutions as repre-

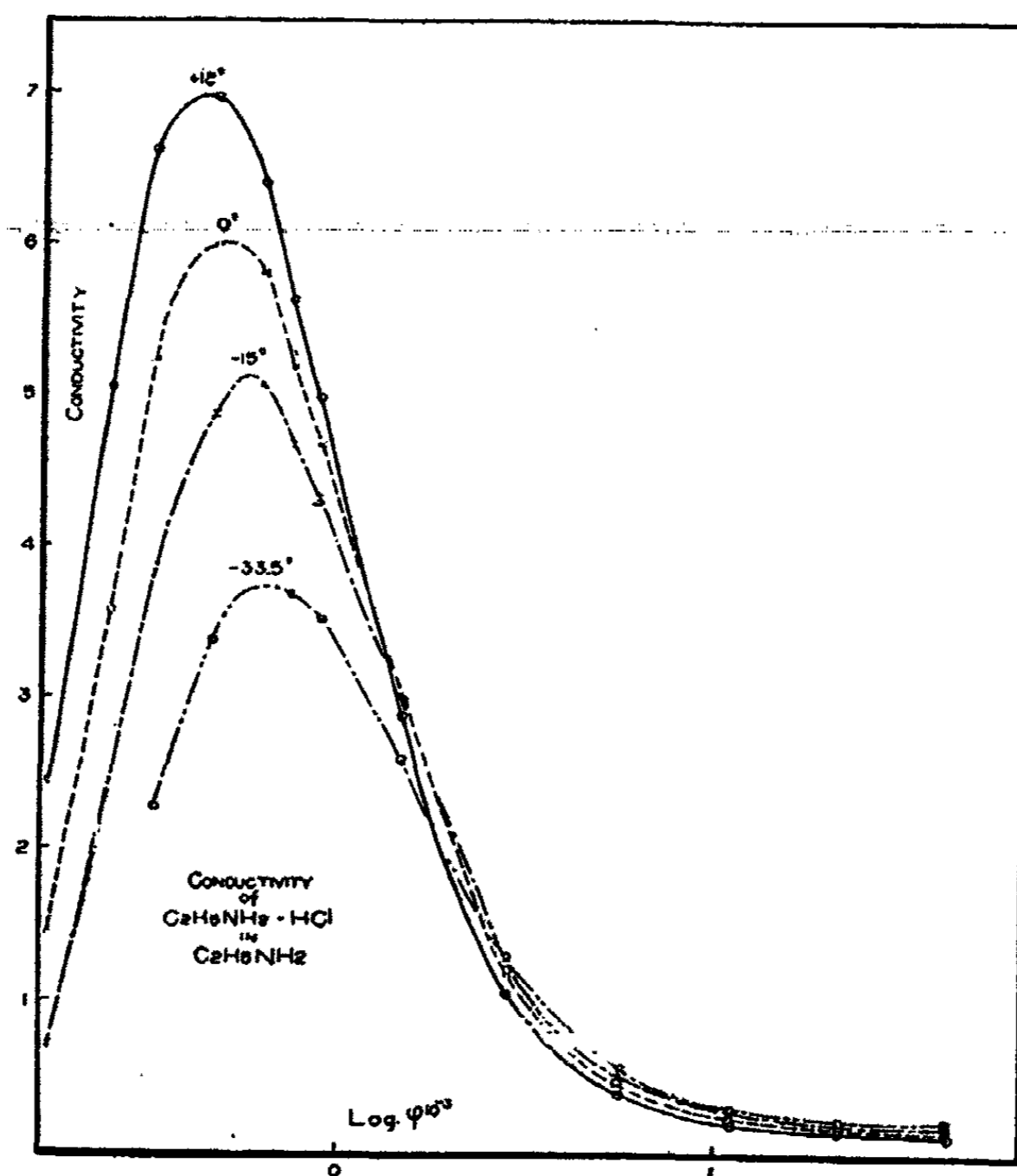

Fig. 6

sented by the curves show a tendency to arrange themselves in the same order as for concentrated solutions.

Finally, it is a matter of some interest to institute a comparison between the typical compound, water with its derivatives, methyl alcohol and ethyl alcohol, on the one

hand, and ammonia and its derivatives, methylamine and ethylamine, on the other. Methylamine and ethylamine are in a sense the methyl and ethyl alcohols of Franklin's ammonia system and as such they should show variations in their properties from the typical substance, ammonia, in many respects similar to those shown by methyl and ethyl alcohols with respect to water. That the analogies thus indicated are certainly more than purely formal are shown by the work of Gibbs<sup>1</sup> on the solvent powers of methylamine and by the conductance measurements recorded in this paper. Water is the solvent par excellence for salts and it possesses practically the highest ionizing power of any known solvent. Methyl alcohol dissolves many salts and its ionizing power, while much below water, is still fair, while its power as a solvent for compounds of carbon is far above that of water. The powers of ethyl alcohol as a solvent for salts and as an ionizing agent are considerably below those of methyl alcohol, while its power as a solvent for the compounds of carbon are somewhat superior to the simplest alcohol. Similar relationships apparently exist between ammonia and its alkyl derivatives. Ammonia is an excellent solvent for many salts although its power in this respect is by no means as wide as that of water, and while by no means as powerful an ionizing agent as water it is nevertheless one of the conspicuously good ionizing agents. In its capacity as a solvent for the compounds of carbon it is interesting to note a conspicuous superiority over water. As is to be expected from the formal relationship between ammonia and its alkyl derivatives, it is interesting to find in methylamine a substance which on the one hand is distinctly inferior to ammonia as a solvent for salts and in its ionizing power, while on the other hand as a solvent for the compounds of carbon it not only surpasses ammonia but apparently the alcohols themselves.<sup>2</sup> Ethylamine is a poorer solvent for the few salts studied than is methylamine and its ionizing power is certainly much below

<sup>1</sup> Jour. Am. Chem. Soc., 28, 1395 (1906).

<sup>2</sup> Vide Gibbs: Jour. Am. Chem. Soc., 28, 1395 (1906).

that of the simplest amine. Its capacity as a solvent for compounds of carbon has not been studied but from the manner in which it attacked the shellac varnish on a shelf upon which a portion of the amine was spilled it seems safe to assume conspicuous power for it in this respect. From the experience of this laboratory the writer is of the opinion that the amines will prove themselves valuable solvents.

## PART II.—THE FLUIDITIES OF AMMONIA, METHYLAMINE AND SULPHUR DIOXIDE

### Introduction

The exceptionally high values for the maximum molecular conductance of salts in solution in liquid ammonia as obtained by Franklin and Kraus<sup>1</sup>, and the experimentally measured ionic velocities which were shown by Franklin and Cady<sup>2</sup> to be from two and a half to three times as great in ammonia at  $-33.5^{\circ}$  as in water at  $18^{\circ}$ , have been assumed to be due to the low viscosity of liquid ammonia as compared with water. It seemed desirable therefore to make direct experimental determinations of the viscosity of this solvent.

Furthermore, in view of the success of Dutoit and Gyr<sup>3</sup> in following the molecular conductance of salts in solutions in liquid sulphur dioxide to their final maximum values at high dilution, it was determined to include measurements of the viscosity of liquid sulphur dioxide in order to test Walden's rule<sup>4</sup> in its application to this solvent.

Measurements were begun on the viscosity of methylamine and its solutions, for the reason that it was deemed easier to manipulate this solvent and thus gain experience necessary for successfully working with the other two solvents. A result of this order of taking up viscosity measurements

<sup>1</sup> Am. Chem. Jour., 23, 277 (1900); Jour. Am. Chem. Soc., 27, 191 (1905).

<sup>2</sup> Jour. Am. Chem. Soc., 26, 499 (1904).

<sup>3</sup> Jour. Chim. Phys., 7, 189 (1909).

<sup>4</sup> p. 645.

has been that data for ammonia and sulphur dioxide are much more meager than those pertaining to the former solvent.

The measurements were made in accordance with the well known Poiseuille method. A modified form of the Ostwald viscosimeter was used, descriptions of which together with an account of the method of manipulation are given in the third part of this paper.

#### Experimental Results

*Methylamine.*—Five determinations of the density of methylamine at  $0^{\circ}$  gave 0.6869, 0.6860, 0.6861, 0.6862 and 0.6869, mean 0.6864 as the value of this constant referred to water at  $0^{\circ}$ . The time of outflow of water at  $0^{\circ}$  for the viscosimeter used was 157.5 seconds. The time of outflow of methylamine at the same temperature was 30.5 seconds. The viscosity of water at  $0^{\circ}$  according to Thorpe and Rodger<sup>1</sup> is 0.01778. Calculated in accordance with the formula given below<sup>2</sup> the viscosity  $\eta$  of methylamine is found to be 0.002364, and since fluidity is the reciprocal of viscosity, the fluidity  $\phi$  of methylamine at  $0^{\circ}$  is 423.1.

*Liquid Ammonia.*—The form of apparatus and the method of manipulation used in the determination of the fluidity of ammonia are described in detail in the third part of this paper. With two viscosimeters, each calibrated for two times of outflow, the following results have been obtained, assuming 0.6823 as the specific gravity of liquid ammonia at  $-33.5^{\circ}$ .<sup>3</sup>

Column I gives the number of the viscosimeter used in making the measurement; column II the mark to which the level of the liquid in the viscosimeter was adjusted; column III the observed time of outflow for water at  $0^{\circ}$  for the corresponding level; column IV the time of outflow for ammonia at  $-33.5^{\circ}$ , and columns V and VI, the corresponding calculated viscosity and fluidity, respectively:

<sup>1</sup> Landolt-Börnstein-Meyerhoffer, Physikalisch Chemische Tabellen.

<sup>2</sup> p. 649.

<sup>3</sup> Determination by the author. Cf. p. 654.



I	II <sup>1</sup>	III	IV	V	VI
1	J	170.7	37.6	0.002672	374.3
1	Ja	203.6	44.5	0.002651	377.3
3	J	244.4	53.8	2669	374.6
3	Ja	284.0	62.2	2656	376.5
				Mean	376.0

These results are not in as close agreement as the simple measurement of the times of outflow would lead us to expect. The error, the elimination of which has not been attempted, undoubtedly has its source in the viscosimeters not satisfying the conditions required for eliminating loss of kinetic energy in the form of eddies below the foot of the capillary. The mean of the above results, 376.0, may be taken as representing the fluidity of liquid ammonia at  $-33.5^{\circ}$  with a fair degree of approximation.

*Sulphur Dioxide.*—Viscosimeter 1 mark J was used in measuring the viscosity of liquid sulphur dioxide. Measurements were carried out at three temperatures as indicated in the table. The experimental data and the results of calculation of the viscosities and fluidities in accordance with the formulas given below are as follows: Time of outflow of water at  $0^{\circ}$  was 170.7 seconds. The specific gravities of sulphur dioxide were obtained by interpolation from the results of Lange.<sup>2</sup>

Column I gives the temperature at which the measurement was made; column II the observed time of outflow of the liquid; column III the interpolated density of the liquid; and column IV and V the calculated viscosity and fluidity, respectively:

I	II	III	IV	V
$-33.5^{\circ}$	49.9	1.5174	0.005508	181.6
$-10.5^{\circ}$	40.3	1.4613	0.004285	233.4
$+ 0.1^{\circ}$	37.7	1.4350	0.003936	254.1

<sup>1</sup> Vide Viscosimeter Constants, p. 659.

<sup>2</sup> Zeit. angew. Chem., 1899, 275.

### The Product $\eta A_{\infty}$

Walden<sup>1</sup> has found that for a considerable number of non-aqueous solvents the product of the viscosity of the solute into the maximum molecular conductance of his normal solute, tetraethylammonium iodide, is a constant independent of the nature of the solvent and of the temperature. It becomes desirable therefore to determine whether this rule holds for the non-aqueous solvents whose viscosities are recorded above. Walden finds that his normal electrolyte gives more concordant results for the product  $\eta A_{\infty}$  than do such binary salts as the iodides of sodium and potassium, facts due, as he plausibly shows, to the higher molecular volume of tetraethylammonium iodide. Unfortunately, however, tetraethylammonium iodide is insoluble in liquid ammonia and its maximum molecular conductance in liquid sulphur dioxide is unknown, thus rendering impossible a comparison of  $\eta A_{\infty}$  for these solvents with the constant calculated by Walden. However, Walden has calculated the value of the product of the maximum molecular conductance of potassium iodide in a number of solvents into the viscosity of the respective solvents which are included in the table given herewith together with the corresponding data for liquid ammonia and liquid sulphur dioxide.

A comparison of the values for  $\eta A_{\infty}$  for ammonia and sulphur dioxide with the data given by Walden shows that these solvents, like water, must be accepted as exceptions to the rule, the values obtained being intermediate between the values for water and 0.650 the mean of the value given by Walden for the remaining solvents given in the table. Whether a solute of much higher molecular volume will give more concordant results must be left to the future for determination.

Walden<sup>2</sup> makes use of the relationship expressed by the equation:

$$A_{\infty} = \frac{A_2 \sqrt[3]{V_2} - A_1 \sqrt[3]{V_1}}{\sqrt[3]{V_2} - \sqrt[3]{V_1}}$$

<sup>1</sup> Zeit. phys. Chem., 55, 207 (1906); 78, 257 (1911).

<sup>2</sup> Loc. cit.

Solvent	Temp.	$\eta$	$\Lambda_{\infty}$	$\eta\Lambda_{\infty}$
Sulphur dioxide	-15	0.004521 <sup>1</sup>	207 <sup>2</sup>	0.937
	0	0.003936	{ 247 <sup>3</sup> 287 <sup>4</sup>	{ 0.972 1.130
	-10.5	0.004285	{ 224 <sup>3</sup> 263 <sup>4</sup>	{ 0.961 1.127
	-33.5	0.005508	{ 176 <sup>3</sup> 203 <sup>4</sup>	{ 0.970 1.117
	Ammonia	-33.5	0.00266	{ 340 <sup>6</sup> 349 <sup>6</sup> 353 <sup>7</sup> 397 <sup>8</sup>
Water <sup>9</sup>	18	0.01054	131.1	1.38
	25	0.00891	154.0	1.39
Methyl alcohol	25	{ 0.00553 0.00580	117.1	{ 0.697 0.679
Ethyl alcohol	0	0.0180	35.0	0.630
	18	0.0125	49.3	0.616
	25	0.0110	57.8	0.636
Acetone	0	0.00395	165.0	0.652
	25	0.00308	210.0	0.647
Acetonitrile	0	0.00442	153.0	0.676
	25	0.00345	201.0	0.693
Pyridine	0	0.0136	46.3	0.630
	25	0.00894	71.5	0.679

<sup>1</sup> Interpolated from author's measurements.

<sup>2</sup> Dutoit and Gyr: Jour. Chim. Phys., 7, 189 (1909).

<sup>3</sup> Calculated from Franklin's data (Jour. Phys. Chem., 23, 277 (1900)), by means of Ostwald's formula,  $\Lambda_{\infty} = (A_1^2 A_2^2 V_2 - A_2^2 A_1 V_1) / (A_1^2 - V_2 A_2^2 V_1)$ , that is, on the assumption that at high dilutions Ostwald's dilution law is followed.

<sup>4</sup> Calculated from Franklin's data by means of Walden's formula.

<sup>5</sup> Value given by Franklin and Kraus (Am. Chem. Jour., 23, 288 (1900)) for potassium bromide.

<sup>6</sup> Highest value obtained by Franklin and Kraus for potassium bromide uncorrected for conductance of solvent.

<sup>7</sup> Calculated by means of Ostwald's formula from data for potassium bromide of Franklin and Kraus.

<sup>8</sup> Calculated by means of Walden's formula from data of Franklin and Kraus for potassium bromide.

<sup>9</sup> Data for water and succeeding solvents taken from Walden's paper.

and apparently with very satisfactory results, for calculating  $\Lambda_{\infty}$  for solutions in which it is impracticable to determine the maximum molecular conductance experimentally.

Especially interesting and tending to fix one's confidence in the use of this formula are Walden's recalculations of the results of Dutoit and Dupersthuis<sup>1</sup> which bring the values of  $\eta \Lambda_{\infty}$  for these measurements into harmony with his rule. Calculations of  $\eta \Lambda_{\infty}$  from the experimental results of Franklin and Kraus on liquid ammonia and of Franklin on liquid sulphur dioxide however fail to bring these solvents into line, and it is moreover difficult to believe that the high values obtained can in reality represent the truth with respect to the maximum molecular conductance in these solvents.

### PART III.—THE FLUIDITY AND DENSITY OF METHYLAMINE AND LIQUID AMMONIA SOLUTIONS

#### Methylamine Solutions

The nature of the solvent to be investigated rendered necessary the construction of a special form of viscosimeter which is shown in Fig. 7. D, E, R and F are the capillary tube and the cistern, respectively, of the viscosimeter proper. The two branches are connected above by way of C to prevent any escape of the volatile solution and to exclude atmospheric air. H is a vessel in which the solutions are made up and of which the volumes to the respective glass pointers are known. The stopper in the neck of this vessel is held in place against the internal pressure by means of a cap which screws down over the collar cemented to the neck of the tube. During the operations of making up the solutions and observing the flow of the liquid through the capillary, the apparatus was immersed in a Dewar

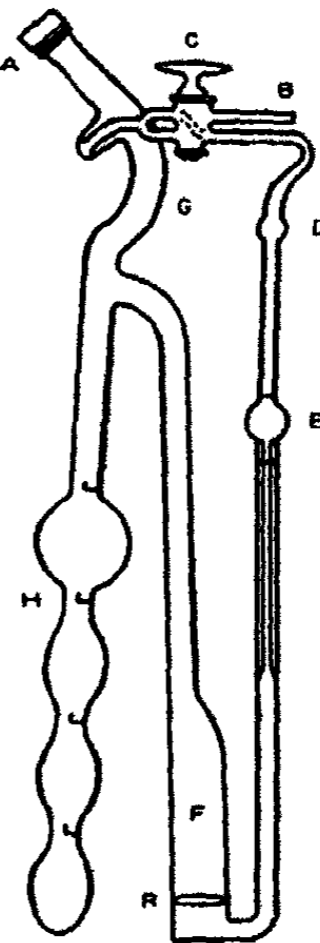

Fig. 7

<sup>1</sup> Jour. Chim. Phys., 6, 726 (1908).

cylinder filled with water and crushed ice which is kept at constant temperature with the aid of a mechanical stirrer.

*Manipulation.*—After weighing the viscosimeter it is placed in a thermostat and connected to a supply of methylamine contained in a steel cylinder, by means of a small lead tube attached to the viscosimeter at B by means of sealing wax. A weighed quantity of solute is then introduced through the opening at A after which the opening is closed by means of a cork stopper and the metal cap is screwed down. Methylamine is then distilled into leg H until the surface of the solution is accurately adjusted to the top of the first glass pointer, care being taken before final adjustment to insure homogeneity of the solution. The apparatus is then removed from the ice bath, permitted to come to room temperature and weighed. The data necessary for calculating the specific gravity and dilution of the solution thus become known.<sup>1</sup> Again cooling the legs of the viscosimeter to zero, a portion of the solution is poured from H into leg F until the latter is filled to the mark R, after which the apparatus is returned to the thermostat and immersed to a point just below bulb D. To determine the outflow time of the solution stopcock C is closed and bulb D is barely touched with a tuft of cotton moistened with liquid ammonia. This causes the solution to rise into bulb D. Stopcock C is then opened so as to place the two parts of the apparatus in communication and the time of outflow read as usual with an Ostwald viscosimeter.

For a second dilution the solution in F is poured back into H, and F thoroughly washed by distillation of the solvent from H to F and subsequent pouring back into H. More methylamine is then distilled into the apparatus through tube B until the cell is filled to pointer 2. The solution is thoroughly mixed and the volume adjusted to pointer 2 as described above for pointer 1. The apparatus is again weighed,

---

<sup>1</sup> The fact that all or a considerable portion of air in the apparatus is replaced by gaseous methylamine introduces no considerable error in density determinations, since the density of methylamine vapor is but little greater than the air displaced.

the solution poured over into F up to mark R and the time of outflow determined. The procedure thus described is repeated for dilution three. After the third dilution the methylamine is distilled off and recovered; the tube cleaned, when the apparatus is in readiness for a new series of measurements.

The methylamine used was part of a kilogram made by Kahlbaum and was the same as used by Franklin and Gibbs.<sup>1</sup> The purchase of this material was rendered possible by a grant from the Trustees of the Bache Fund to whom acknowledgements are here made again.

*Cell Constants.*—The volumes of the side tube H to the three pointers 1, 2 and 3 were 4.35, 8.13 and 12.08 cubic centimeters, respectively, at 18°. The time of outflow for water at 0° was 157.5 seconds.

*Calculation of Results.*—The specific gravities of methylamine and its solutions were obtained by dividing the weight of water required to fill the cell to the respective pointers at 18° into the weight of methylamine or its solutions required to fill the cell to the same pointer without the introduction of any corrections. The viscosities were calculated by means of the well-known formula

$$\eta = \frac{\eta_0 S t}{S_0 t_0}$$

in which  $S_0$  and  $\eta_0$  and  $t_0$  represent respectively the specific gravity, viscosity and time of outflow of water and  $S$ ,  $\eta$  and  $t$  the corresponding constants for the second liquid.

#### Experimental Data

The results obtained in this investigation are given in the following tables, in which  $\phi \cdot 10^{-3}$  represents the dilution in liters per mol.,  $D$  the density and  $\phi$  the fluidity.

*Potassium Iodide.*—The salt used for the following measurements was from an analyzed specimen by J. T. Baker, which received no treatment before use other than thorough desiccation. Potassium iodide dissolves in methylamine to a clear and colorless solution.

<sup>1</sup> Jour. Am. Chem. Soc., 29, 10 (1907).

$\varphi \cdot 10^{-3}$	D	$\phi$	$\varphi \cdot 10^{-3}$	D	$\phi$
I			IV		
3.328	0.7335	363.2	6.796	0.7109	391.6
II			12.71	0.6995	405.2
0.8230	0.8670	227.7	18.88	0.6947	412.0
1.540	0.7865	304.3	V		
2.287	0.7537	343.3	196.6	0.6778	423.0
III			368.8	0.6889	421.0
24.13	0.6940	414.4	546.2	0.6876	421.7
45.13	0.6939	417.3			
67.02	0.6917	421.3			

*Silver Nitrate.*—Silver nitrate, if free from moisture, dissolves freely in methylamine, giving a clear colorless solution. The strongest solution measured was not far from saturation.

$\varphi \cdot 10^{-3}$	D	$\phi$	$\varphi \cdot 10^{-3}$	D	$\phi$
I			IV		
0.3618	1.137	55.64	10.09	0.7074	396.9
0.6769	0.9354	152.6	18.86	0.6985	409.9
1.005	0.8543	221.6	28.01	0.6934	414.2
II			V		
0.9596	0.8658	205.0	22.17	0.7013	411.6
1.795	0.7839	292.7	61.57	0.6937	418.0
2.666	0.7534	329.4	VI		
III			115.5	0.6939	420.0
3.023	0.7511	334.7	320.8	0.6908	423.5
5.655	0.7206	373.7	VII		
8.396	0.7101	388.6	0.2800	1.261	29.78
			0.5237	1.043	111.06
			0.7778	0.9010	180.8

*Metamethoxybenzenesulfonamide.*—This substance, prepared by E. C. Franklin,<sup>1</sup> is soluble in methylamine, producing a clear colorless solution.

<sup>1</sup> J. H. U. Dissertation, 1894.

$\varphi \cdot 10^{-3}$	D	$\phi$	$\varphi \cdot 10^{-3}$	D	$\phi$
I			III		
16.42	0.6950	409.2	0.2660	1.104	8.015
30.72	0.6940	414.4	0.4973	0.9173	90.19
45.61	0.6915	417.4	0.7385	0.8453	175.5
II			IV		
0.7868	0.8301	177.6	2.962	0.7288	351.3
1.471	0.7674	280.2	5.540	0.7101	380.3
2.184	0.7386	314.6	8.226	0.7006	400.1

*Carbamide.*—The sample used was from a Kahlbaum "special" preparation. Carbamide is very soluble in methylamine, giving a clear colorless solution.

$\varphi \cdot 10^{-3}$	D	$\phi$	$\varphi \cdot 10^{-3}$	D	$\phi$
I			III		
0.3004	0.7741	156.8	11.58	0.6916	414.5
0.5718	0.7556	253.2	17.19	0.6893	418.7
1.070	0.7243	326.2	29.95	0.6893	418.7
II			IV		
2.618	0.7051	376.2	82.84	0.6910	425.9
4.896	0.6973	390.9	155.0	0.6923	423.8
7.270	0.6935	400.5	504.8	0.6861	424.7

*Cane Sugar.*—This substance dissolves freely in methylamine, producing in concentrated solution a sirupy liquid.

$\varphi \cdot 10^{-3}$	D	$\phi$	$\varphi \cdot 10^{-3}$	D	$\phi$
I			III		
3.653	0.7496	264.8	46.14	0.6907	410.0
			86.31	0.6900	416.8
			128.2	0.6879	419.6
II			IV		
6.925	0.7228	335.9	0.6943	1.016	2.24
12.95	0.7041	373.4	1.031	0.9156	29.65
19.24	0.6987	392.6			

*Silver Iodide.*—This salt was prepared in the laboratory and thoroughly dried. Silver iodide is extremely soluble in



methylamine, but less soluble than in liquid ammonia. The concentrated solutions are surprisingly fluid.

$\varphi \cdot 10^{-3}$	D	$\phi$	$\varphi \cdot 10^{-3}$	D	$\phi$
I			III		
0.9235	0.9274	293.9	13.92	0.7071	412.0
1.728	0.8148	353.7	26.05	0.6992	416.8
2.565	0.7729	372.2	38.68	0.6939	416.0
II			IV		
2.919	0.7672	376.2	0.4326	1.170	197.0
8.110	0.7134	404.6	0.8094	0.9464	282.7

*1-2-4-Dinitranilin.*—The salt used was from a sample by Kahlbaum.

$\varphi \cdot 10^{-3}$	D	$\phi$	$\varphi \cdot 10^{-4}$	D	$\phi$
I			IV		
6.195	0.7108	390.6	1.955	0.7650	312.1
11.59	0.7028	404.0			
II			V		
17.36	0.6928	416.6	1.502	0.7778	282.0
32.48	0.6949	419.6	2.810	0.7387	339.1
48.22	0.6889	423.1	4.173	0.7207	371.3
III					
133.0	0.6933	422.8			
369.6	0.6874	425.4			

*Sodium Nitrate.*—This specimen of Kahlbaum received no treatment before use other than thorough drying.

$\varphi \cdot 10^{-3}$	D	$\phi$	$\varphi \cdot 10^{-3}$	D	$\phi$
I			III		
0.9296	0.7711	267.2	22.09	0.6939	415.9
1.739	0.7300	337.9			
2.582	0.7139	365.0			
II			IV		
4.426	0.6960	389.4	175.3	0.6908	422.2
8.280	0.7036	402.4	327.9	0.6884	420.0
12.29	0.6969	410.0	486.9	0.6873	423.7

*Lithium Chloride.*—For use in this experiment a sample of Kahlbaum's special salt was dissolved in water, precipitated by hydrochloric acid and dried by heating in a stream of gaseous hydrochloric acid.

$\varphi \cdot 10^{-3}$	D	$\phi$	$\varphi \cdot 10^{-3}$	D	$\phi$
I			III		
0.4986	0.7802	107.0	6.939	0.6961	393.4
0.7404	0.7530	182.4	12.98	0.6939	407.9
			19.28	0.6901	414.1
II					
1.015	0.7365	232.7			
1.899	0.7137	315.8			
2.819	0.7060	356.5			

Tetramethylammonium iodide and trimethylsulfonium iodide are practically insoluble in methylamine.

#### Liquid Ammonia Solutions

It was not deemed desirable to attempt the adaption of the apparatus used for measuring the fluidity of methylamine and its solutions to the study of liquid ammonia. An entirely new form of viscosimeter was therefore constructed, a description of which, together with an account of the method of its manipulation, is given below. Since in this form of viscosimeter it was not possible to combine specific gravity and viscosity measurements into one series of operations, the density determinations were made in a separate piece of apparatus shown in Fig. 8.

The amounts of water required to fill the cell to the four pointers at  $18^\circ$  weighed in air were 4.897, 8.948, 18.683 and 34.352 grams from which the respective volumes 4.903, 8.959, 18.705 and 34.393 cubic centimeters are calculated for the temperature  $-33.5^\circ$ . The total volume of the cell was approximately 37.0 cubic centimeters.

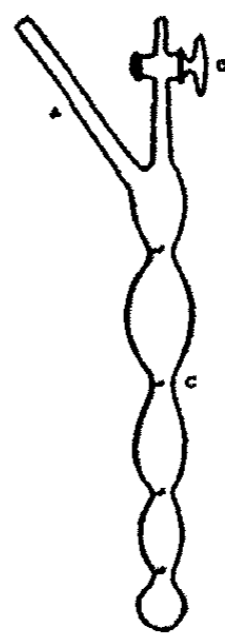

Fig. 8

*The Density of Liquid Ammonia.*—For determining the density of the pure solvent the cell, with the side tube sealed off, was weighed, exhausted of its air content, then filled with ammonia at  $-33.5^{\circ}$  to one of the four glass pointers, and after warming to laboratory temperature, weighed with its contents of ammonia. The results obtained are given in the table in which the values given in the fourth column are obtained by simply dividing the apparent weights of ammonia required to fill the cell to the respective pointers at  $-33.5^{\circ}$  by the weight of water required to fill the cell to the same pointer at  $18^{\circ}$ . In column 5 are given the values for the true density of liquid ammonia at  $-33.5^{\circ}$  referred to water at  $4^{\circ}$ .

No.	Wt. of cell + NH <sub>3</sub>	Wt. of cell	Density uncorrected	D-33.5 <sub>4</sub>
1	69.014	45.569	0.6819	0.6821
2	69.050	45.624	0.6821	0.6823
3	69.043	45.624	0.6819	0.6821
4	58.327	45.596	0.6815	0.6821
5	58.363	45.624	0.6820	0.6825
6	58.376	45.624	0.6826	0.6832
7	58.378	45.624	0.6827	0.6833
8	51.666	45.571	0.6813	0.6825
9	48.907	45.571	0.6813	0.6836

The data of experiments 1, 2 and 3 were obtained with the cell filled to pointer 4; those under 4, 5, 6 and 7 with the cell filled to pointer 3; and those under 8 and 9 filled to pointer 2 and 1, respectively.

Omitting determinations 8 and 9, for the reason that they were made on small quantities of liquid, the mean of the seven remaining determinations is found to be 0.6825 for the liquid at its boiling point referred to water at its maximum density. The mean of the uncorrected values is 0.6821, which in view of the variations among the individual determinations is practically identical with the corrected value.

These results are in rather poor agreement with the value 0.6757 obtained by Lange,<sup>1</sup> but agree fairly well with the

<sup>1</sup> Zeit. angew. Chem., 1899, 275.

results of Drewes<sup>1</sup> and Dieterici<sup>2</sup> to the extent that whereas the data of Drewes and Dieterici between 0° and 100°, the limits within which their measurements were confined, are approximately one percent higher than those obtained by Lange; so also are the results recorded in this paper for -33.5° higher than Lange's value at the same temperature by an amount of the same order.

*Density of Liquid Ammonia Solutions.*—The following procedure was followed in determining the density of liquid ammonia solutions: A weighed quantity of solute is introduced into the cell shown in Fig. 8, after which the tube is closed by sealing off the tubulure A before the blowpipe, and weighed together with the salt. After the solute has dissolved and the operator has satisfied himself of the homogeneity of the solution, the surface of the liquid is adjusted accurately to the glass pointer. The tube is then allowed to come to laboratory temperature when it is weighed. The data for the calculation of the concentration and the specific gravity of the solution thus become known. More liquid is then distilled into the tube to the points two, three and four. After the last pointer has been reached, the cell is emptied, a new neck is sealed on the tube A, when the apparatus is ready for a new series of measurements.

In the tables which follow are given under D the densities of the solutions of a number of salts in liquid ammonia at the respective dilutions given in the first column under the superscripture  $\varphi \cdot 10^{-3}$ . The density values recorded are obtained by simply dividing the weights of water at 18° required to fill the cell to the respective pointers, into the weight of solution required to fill the cell to the same pointer at -33.5°.

---

<sup>1</sup> Dissertation, Hannover, 1903.

<sup>2</sup> Zeit. gesämmt. Kälteind., 11, 1 (1904).

<i>Potassium Iodide</i>		<i>Sucrose</i>	
$\varphi \cdot 10^{-3}$	D	$\varphi \cdot 10^{-3}$	D
I		I	
0.2255	1.2910	0.5821	1.054
0.4709	0.9790	1.215	0.8640
0.8658	0.8441	2.235	0.7814
II		II	
0.9114	0.8385	3.313	0.7517
1.665	0.7671	6.054	0.7180
3.477	0.7243	12.64	0.6984
6.393	0.7053	23.25	0.6913
<i>Sodium Nitrate</i>		<i>Cu(NO<sub>3</sub>)<sub>2</sub>·4NH<sub>3</sub></i>	
I		I	
0.2433	0.9479	0.7823	0.9085
0.5079	0.8136	1.430	0.8069
0.9340	0.7559	2.986	0.7420
II		II	
1.329	0.7322	5.488	0.7157
III		III	
2.072	0.7144	8.525	0.7012
3.786	0.6980	15.58	0.6934
7.907	0.6907	32.53	0.6873
14.53	0.6867	59.80	0.6851
<i>Silver Iodide</i>		<i>Urea</i>	
I		I	
0.5406	1.0780	0.4751	0.7527
0.9879	0.8995	0.8682	0.7220
2.063	0.7865	1.812	0.7005
3.792	0.7385	3.333	0.6930
II		II	
0.1305	2.301	0.5072	0.7522
0.2384	1.5740	1.059	0.7152
0.4978	1.114	1.947	0.7005
0.9152	0.9185	<i>Ammonium Bromide</i>	
III		I	
2.531	0.7690	0.2335	1.0015
4.625	0.7277	II	
9.656	0.6970	0.7108	0.7927
17.75	0.6946		

Ammonium Bromide—(Continued)		Silver Nitrate	
$\varphi \cdot 10^{-3}$	D	$\varphi \cdot 10^{-3}$	D
III		I	
1.299	0.7426	1.356	0.7991
IV		2.478	0.7474
2.711	0.7113	5.175	0.7137
4.985	0.6983	9.515	0.6994
V		II	
0.2474	0.9875	12.87	0.6925
0.4520	0.8530	23.53	0.6883
0.9436	0.7654	49.12	0.6846
1.735	0.7281	90.33	0.6833

*Fluidity of Liquid Ammonia Solutions.*—The viscosimeter used in measuring the fluidity of liquid ammonia and its solutions and of sulphur dioxide is shown in Fig. 9. L is the Dewar thermostat vessel. The tubes for introducing and removing liquid ammonia and for the escape of ammonia gas from the thermostat are not shown in the figure. The elaborate devices used by Franklin and Cady<sup>1</sup> for maintaining constant temperatures in this bath were dispensed with and dependence placed upon the presence of platinum tetrahedra in the bottom of the bath to prevent superheating.

A series of determinations is carried out as follows: Starting with the clean, dry viscosimeter immersed in the thermostat as shown in the figure, the first operation consists in introducing a weighed quantity of solute by means of a long-stemmed funnel through C into the body of the cell

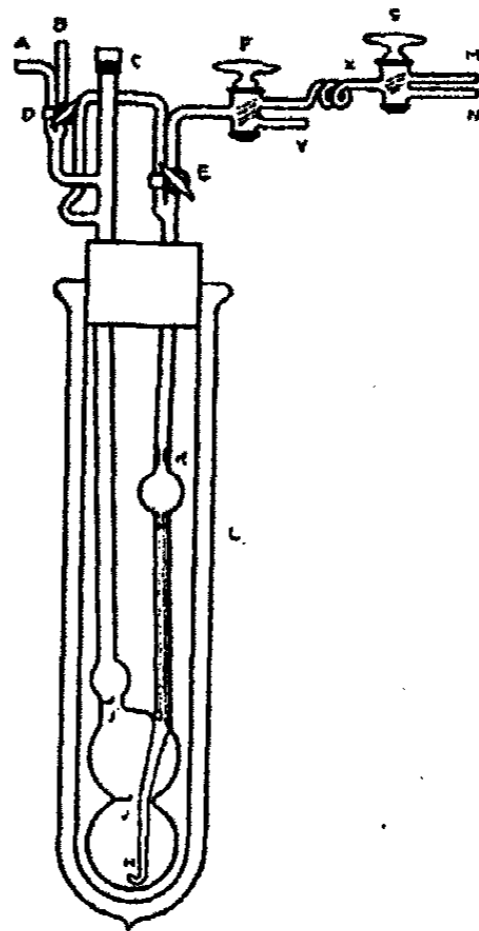

Fig. 9

<sup>1</sup> Jour. Am. Chem. Soc., 26, 499 (1904); Zeit. phys. Chem., 69, 278 (1909).

J'J", after which C is closed with a cork stopper held in position by a metal cap screwed down over C. Ammonia is then distilled into the cell by way of N X F E H until the surface of the solution formed stands slightly above the tip of the glass pointer J. The final adjustment of the volume is accomplished by passing a current of pure, dry hydrogen gas through the solution by way of M X F E H D A. The commotion caused by the passage of the hydrogen ensures homogeneity of the solution and at the same time, volatilizing and carrying off ammonia, enables the operator to adjust the surface of the solution to the pointer J. The known volume of the cell together with the known quantity of solute introduced furnish the data for calculating the concentration of the solution. The next step is the determination of time of outflow of the viscosimeter. To this end E is closed and hydrogen pressure is brought to bear on the surface of the solution in J J' by way of B D. Solution is thus forced up through the capillary tube and into the bulb K. As soon as the surface of the solution reaches a line somewhat above K, the stopcock D is closed and E is opened, thus bringing about equality of pressure in the two legs of the apparatus, and establishing the conditions required for determining the time of outflow which latter is recorded by means of a good stop-watch. A second dilution is made by distilling additional ammonia into the cell and adjusting the surface of the solution to the pointer J' in the manner already described for pointer J. After emptying the cell until the surface of the solution reaches pointer J, readings of the time of outflow are again made. The cell is now emptied and washed clean preparatory to charging with a fresh solution. Operations to this end are as follows: Hydrogen pressure is turned upon the surface of the solution through B D when, with stopcocks E and F set to open through Y, the solution will be forced over into a suitable waste vessel. Stopcock D is then opened through A, and ammonia gas is run into the cell by way of N S F E, thus displacing the hydrogen. Closing D will determine the liquefaction of ammonia in the cell. This wash liquid is then

removed after the manner described above. The washing is continued until the cell is free from solute, when the apparatus is in readiness for repeating the operations described with fresh solutions.

*Viscosimeter Constants.*—The capacities of viscosimeter No. 1 at 18° are 14.83 and 31.83 grams of water, respectively, to pointers J and J', with the liquid standing at capillary height in the tube H K, and 18.67 grams to pointer J with the tube H K E filled to stopcock E. This volume will be referred to as volume Ja. The time of outflow of water at 0° for mark J is 170.7 seconds; for mark Ja, 203.6 seconds. The glass pointer J of viscosimeter No. 1 was inadvertently broken off. The sealing in of a new pointer changed the value of mark J to 14.74. The cell thus repaired will be called viscosimeter No. 2. The volumes of viscosimeter 3 to mark J, Ja and J' at 18° are 11.05 cc., 14.66 cc., and 26.03 cc., respectively. The time of outflow of water at 0° for mark J is 244.4 seconds, for mark Ja, 284.0 seconds.

*Experimental Results.*—In the tables which follow are given the dilutions in liters per gram molecule, the specific gravities—obtained by interpolation from the results recorded in earlier pages of this article—and the fluidities of the solutions under the respective superscriptures,  $\varphi \cdot 10^{-3}$ , D and  $\phi$ .



## FLUIDITIES OF LIQUID AMMONIA SOLUTIONS

<i>Potassium Iodide</i> Viscosimeter No. 1			<i>Silver Iodide</i> Viscosimeter No. 1		
$\varphi \cdot 10^{-3}$	D	$\phi$	$\varphi \cdot 10^{-3}$	D	$\phi$
I			0.1377	2.2275	10.12
0.2319	1.275	69.17	0.2956	1.4250	108.6
0.4979	0.963	189.7	0.5040	1.1175	195.9
II			Viscosimeter No. 3		
0.8549	0.850	254.3	1.182	0.8588	284.8
1.835	0.755	319.2	2.787	0.7590	335.6
3.130	0.7275	348.3	4.960	0.7215	355.9
5.335	0.709	355.8	8.804	0.6900	372.2
9.097	0.6965	366.3	15.63	0.6840	375.3
15.51	0.689	372.8	27.75	0.6820	376.4
<i>Sodium Nitrate</i> Viscosimeter No. 1			<i>Sucrose</i> <sup>1</sup> Viscosimeter No. 3		
I			1.086	0.985	44.76
0.3035	0.896	113.8	2.558	0.970	164.3
0.6518	0.788	224.0	4.541	0.730	278.0
1.111	0.746	277.1	8.063	0.708	321.4
1.894	0.718	314.7	14.32	0.695	345.0
3.229	0.702	341.3	25.42	0.690	360.0
5.507	0.6935	356.1	45.12	0.686	367.2
9.389	0.6895	363.1	<i>Cu(NO<sub>3</sub>)<sub>2</sub>·4NH<sub>3</sub></i>		
16.01	0.685	368.2	Viscosimeter No. 1		
27.29	0.683	371.8	I		
II			0.7537	0.9120	127.2
1.109	0.746	274.4	1.618	0.792	235.5
2.380	0.710	328.5	2.759	0.747	287.7
4.058	0.697	347.4	<sup>1</sup> A solution containing 74.2 grams in 100 cc of solution " $\varphi/1000 = 0.427$ " was so viscous that the bulb K had not half emptied itself in four hours.		
6.918	0.692	359.7			
11.80	0.687	367.1			
20.11	0.684	371.7			

$\varphi \cdot 10^{-3}$	D	$\phi$	<i>Ammonium Bromide</i>		
II			Viscosimeter No. 2		
4.423	0.724	313.4	$\varphi \cdot 10^{-3}$	D	$\phi$
9.497	0.699	347.2	I		
15.20	0.693	361.7	0.2452	0.990	68.46
27.63	0.688	368.3	0.5295	0.836	185.8
<i>Urea</i>			0.9065	0.766	255.3
Viscosimeter No. 1			1.552	0.734	300.9
0.4818	0.752	243.0	II		
1.935	0.717	306.0	2.992	0.708	329.8
1.764	0.702	340.2	6.462	0.694	359.5
3.007	0.694	356.4	11.06	0.689	366.1
5.128	0.688	366.2	<i>Silver Nitrate</i>		
8.742	0.684	372.1	Viscosimeter No. 1		
14.90	0.683	376.0	1.689	0.7750	282.7
II			3.624	0.7275	329.6
1.240	0.711	319.1	6.180	0.7070	349.2
2.663	0.6955	351.9	10.54	0.6940	363.4
4.539	0.6895	363.5	17.97	0.6880	368.3
7.739	0.685	368.3	30.63	0.6860	371.4
			52.22	0.6835	374.0

This investigation was carried on at Leland Stanford Junior University at the suggestion of Professor E. C. Franklin and under his kindly advice, direction and assistance. All the apparatus used was designed and made by him in the University laboratory.

Stanford University,  
California, May, 1912

## THE SECOND POSITIVE<sup>1</sup>

BY ARTHUR S. ELSENBAST AND GEORGE E. GRANT

During some preliminary work on solarization, we apparently obtained evidence of a second negative at relatively short exposures, followed by a second positive and a third negative. When this phenomenon was studied more carefully, it proved to be non-existent. The trouble is due to the fact that, with long exposures, great differences occur between different boxes of the same make of plate, and there are also differences between plates in the same box.

The following stock solutions were used in all the work:

Solution A		Solution B	
Hydroquinone.....	21g	Cryst. sodium carbonate.	252g
Cryst. sodium sulphite .	126g	Water .....	1000g
Water.....	1000g		

The developer consisted of one part Solution A, one part Solution B, and two parts water. In most cases development was carried on for one minute; but the time is given in all the tables. The plates were fixed in a twenty percent hypo-sulphite solution.

TABLE I  
Arc Light and Seed Lantern Slide Plates

Distance	Exposure	Development	Fixing	Result
30 ft.	1/2 min.	1 min.	3 min.	Negative
30 ft.	1 min.	1 min.	3 min.	Negative
30 cm	1 sec.	1 min.	3 min.	Negative
30 cm	3 sec.	1 min.	3 min.	Mongrel
30 cm	1/2 min.	1 min.	3 min.	Good positive
30 cm	1 min.	1 min.	3 min.	Good positive
30 cm	12 min.	1 min.	3 min.	Poor positive
30 cm	25 min.	1 min.	3 min.	Poor positive
30 cm	90 min.	1 min.	3 min.	Very poor positive
30 cm	100 min.	1 min.	3 min.	Very poor positive

<sup>1</sup> A paper read before the Eighth International Congress of Applied Chemistry in New York, September, 1912.

In the first experiments an arc lamp was used as the source of light. The plates were Seed's Lantern Slide Plates. They were placed behind, and in contact with, a lantern slide at a fixed distance, usually 30 cm, and were exposed for varying times. The data are given in Table I.

From these data it was clear that excessive exposures would be necessary if one wished to get data on a second or third negative as the case might be. We therefore changed to Seed No. 30 plates. Some data with these plates are given in Table II:

TABLE II  
Arc light and Seed No. 30 plates

Distance	Exposure	Development	Fixing	Result
30 cm	$\frac{1}{1}$ sec.	1 min.	3 min.	Good negative
30 cm	$\frac{1}{2}$ sec.	1 min.	3 min.	Mongrel
30 cm	$\frac{3}{2}$ sec.	1 min.	3 min.	Beautiful positive
30 cm	3 sec.	1 min.	5 min.	Positive
30 cm	4 sec.	1 min.	3 min.	Negative
30 cm	4 sec.	1 min.	3 min.	Positive
30 cm	4 sec.	1 min.	5 min.	Positive
30 cm	4 sec.	2 min.	5 min.	Positive
30 cm	7 sec.	1 min.	3 min.	Positive
30 cm	10 sec.	1 min.	3 min.	Negative
30 cm	12 sec.	1 min.	3 min.	Positive
30 cm	30 sec.	$\frac{3}{2}$ min.	5 min.	Fogged positive
30 cm	40 sec.	$\frac{3}{2}$ min.	5 min.	Fogged positive
30 cm	60 sec.	$\frac{3}{2}$ min.	5 min.	Fogged positive
30 cm	90 sec.	1 min.	3 min.	Fogged positive
30 cm	3.5 min.	$\frac{3}{2}$ min.	5 min.	Fogged positive
30 cm	5 min.	1 min.	3 min.	Cloudy negative
30 cm	6 min.	$\frac{3}{2}$ min.	3 min.	Fogged positive
30 cm	9 min.	1 min.	5 min.	Indistinct negative
30 cm	11 min.	1 min.	3 min.	Poor negative
30 cm	15 min.	2 min.	5 min.	Positive
30 cm	60 min.	1 min.	3 min.	Fair positive

In this table we find positives and negatives galore but they are scattered round in a way which is anything but encouraging. While it did not seem probable that the whole trouble could be due to the source of light, yet our 110 volt

D. C. circuit is badly overloaded and the voltage fluctuates very much. Consequently a series of runs were made with exposure to a Welsbach burner. The data are given in Table III:

TABLE III  
Welsbach burner and Seed No. 30 plates

Distance	Exposure	Development	Fixing	Result
30 cm	10 sec.	2 min.	15 min.	Negative
30 cm	30 sec.	2 min.	15 min.	Negative
30 cm	75 sec.	2 min.	15 min.	Negative
30 cm	4.5 min.	1 min.	5 min.	Positive
30 cm	5 min.	1.5 min.	15 min.	Positive
30 cm	6 min.	2 min.	15 min.	Mongrel
30 cm	7.5 min.	2 min.	15 min.	Negative
30 cm	8.5 min.	2 min.	15 min.	Negative
30 cm	10 min.	1 min.	5 min.	Positive
30 cm	20 min.	2 min.	15 min.	Positive
30 cm	30 min.	1 min.	5 min.	Positive
30 cm	45 min.	2 min.	15 min.	Positive
30 cm	3 min.	2 min.	10 min.	Negative
30 cm	4 min.	2 min.	10 min.	Negative
30 cm	4 min.	2 min.	10 min.	Negative
30 cm	5.5 min.	2 min.	10 min.	Negative
30 cm	2 min.	1 min.	10 min.	Negative
30 cm	5.75 min.	1 min.	10 min.	Negative
30 cm	7.5 min.	1 min.	10 min.	Negative

The first series of measurements in Table III point to a first positive for exposures of about five minutes with a second negative at about eight minutes and a second positive at ten minutes. The next two series in Table III show no signs of a positive at about five minutes and consequently the negative at nearly eight minutes is still the first negative. The most plausible explanation seems to be variations in plates. The data in Table IV and V are additional evidences of the difficulty of duplicating results.

A striking feature of Table V is the occurrence of mongrels, which do not change into positives on slightly longer exposure. This could not be an effect due to the source of light because a deterioration of the Welsbach mantle would

TABLE IV  
Welsbach burner and Seed No. 30 plates

Distance	Exposure	Development	Fixing	Result
30 cm	75 sec.	1 min.	15 min.	Negative
30 cm	3 min.	1 min.	15 min.	Mongrel
30 cm	4 min.	1 min.	15 min.	Negative
30 cm	5 min.	1 min.	15 min.	Negative
30 cm	7.5 min.	1 min.	15 min.	Positive
30 cm	10 min.	1 min.	15 min.	Positive
30 cm	12 min.	1 min.	15 min.	Positive
30 cm	2.0 min.	1 min.	15 min.	Negative
30 cm	2.5 min.	1 min.	15 min.	Negative
30 cm	3.0 min.	1 min.	15 min.	Negative
30 cm	3.5 min.	1 min.	15 min.	Negative
30 cm	4.0 min.	2 min.	15 min.	Negative
30 cm	4.5 min.	2 min.	15 min.	Negative
30 cm	5.0 min.	2 min.	15 min.	Negative
30 cm	5.5 min.	2 min.	15 min.	Negative
30 cm	6.0 min.	2 min.	15 min.	Negative
30 cm	6.5 min.	2 min.	15 min.	Mongrel
30 cm	7.0 min.	2 min.	15 min.	Positive
30 cm	10.0 min.	2 min.	15 min.	Positive

TABLE V  
Welsbach burner and Seed No. 30 plates

Distance	Exposure	Development	Fixing	Result
30 cm	6.5 min.	2 min.	15 min.	Negative
30 cm	6.75 min.	2 min.	15 min.	Negative
30 cm	7.0 min.	2 min.	15 min.	Mongrel
30 cm	7.25 min.	2 min.	15 min.	Negative
30 cm	7.5 min.	2 min.	15 min.	Mongrel
30 cm	7.75 min.	2 min.	15 min.	Negative
30 cm	8.0 min.	2 min.	15 min.	Mongrel
30 cm	8.0 min.	2 min.	15 min.	Mongrel
30 cm	8.5 min.	2 min.	15 min.	Mongrel
30 cm	9.0 min.	2 min.	15 min.	Negative
30 cm	9.5 min.	2 min.	15 min.	Negative

merely shove things along. We kept tab on the gas pressure and satisfied ourselves that the very slight fluctuations in pressure during the daytime could not be the cause of the trouble. This conclusion was confirmed by our getting nor-

mal, though different absolute, results in another run. With exposures up to 35 seconds we got a negative; with exposures of 45–60 seconds we obtained mongrels; with exposures of 1.25–30.0 minutes we obtained positives. In still another run, positives were not obtained until exposures exceed two minutes and we were still getting positives after an exposure of an hour.

The most plausible explanation for the erratic results is that we are dealing with plates in which the silver bromide grains do not all have the same sensitiveness. Suppose that our plates contain a fast emulsion mixed with more or less of a slow emulsion. The two sets of grains will solarize at different exposures and the actual blackening will be the sum of the blackenings for the two single emulsions. It is easy to see that the curves for the two single emulsions might be such that they gave an additional maximum in the combined curve or changed things so that a positive could not be obtained when copying a lantern slide having a wide range of densities.

Although efforts were made to keep track of the conditions of development, there was always the possibility of a slight, unknown variation in the conditions. It was therefore decided to develop a number of plates simultaneously in a plate tank. For this we used Eastman's developer for  $4 \times 5$  plates and developed in 36 oz. of solution at  $65^\circ \text{F}$  for twenty minutes, fixing in a hyposulphite bath and washing thoroughly in cold water. Instead of being exposed behind a lantern slide, the plates were placed in a plate holder and the slide withdrawn to such an extent as to give five different exposures on the same plate. The following results were obtained:

- I. Strips exposed  $\frac{1}{5}$ ,  $\frac{3}{5}$ ,  $\frac{5}{5}$ ,  $\frac{7}{5}$ ,  $\frac{9}{5}$  seconds. The density increases with increasing exposure.
- II. Strips exposed 20, 40, 60, 80, 100 seconds. The density increases with increasing exposure.
- III. Strips exposed 110, 115, 120, 125, 130 seconds. Apparently one flat tone; cannot distinguish strips. Density same as 100 seconds exposure in II.

- IV. Strips exposed 135, 140, 145, 150, 155 seconds. Apparently one flat tone; same as III.
- V. Strips exposed 3, 6, 9, 12, 15 minutes. Density decreases with increasing exposure. First strip (3 min.) same density as IV.
- VI. Strips exposed 15, 30, 45, 60, 75 minutes. Density decreases with increasing exposure up to 45 min.; density of the fourth strip (60 min.) same as that of third strip and less than that of fifth strip.
- VII. Strips exposed 3, 4, 5, 6, 7 minutes. Density decreases with increasing exposure.
- VIII. Strips exposed 8, 9, 10, 11, 12 minutes. Density decreases with increasing exposure. VII and VIII duplicate V very well.
- IX. Strips exposed 13, 14, 15, 16, 17 minutes. Apparently one flat tone.
- X. Strips exposed 18, 19, 20, 21, 22 minutes. Apparently one flat tone; same as IX.
- XI. Strips exposed 25, 27, 29, 31, 33 minutes. Apparently one flat tone; same as X.
- XII. Strips exposed 35, 37, 39, 41, 43 minutes. Flat; same as IX-XI.
- XIII. Strips exposed 15, 30, 45, 60, 75 minutes. Density decreases with increasing exposure for first three strips; density of last three strips practically the same, though last strip may be a little the darkest.
- XIV. Strips exposed 50, 55, 60, 65, 70 minutes. Apparently one flat tone.
- XV. Strips exposed 2, 4, 6, 8, 10 minutes. Decreasing density with increasing exposure.
- XVI. Strips exposed  $\frac{1}{2}$ ,  $\frac{3}{2}$ ,  $\frac{5}{2}$ ,  $\frac{7}{2}$ ,  $\frac{9}{2}$  minutes. Decreasing density with increasing exposure. Does not agree well with II and III.
- XVII. Strips exposed 3, 30, 70, 110, 150 minutes. Decreasing density with increasing exposure for first four strips. Last strip (150 min.) darker than fourth strip.



These experiments seem to show that the strips increase rapidly in density as the exposures increase from 0.2 second to 1.8 seconds; that the density increases gradually as the exposure increases from 1.8 seconds to 100 seconds. With exposures varying from two to three minutes there is only a very slight change in density. There is a slow decrease in density as the exposures increase from three minutes to twelve minutes, and practically no change in density with exposures increasing from twelve minutes to seventy minutes. These conclusions are based on qualitative measurements. That there is a decreasing density with exposures increasing from three minutes to one hundred and ten minutes appears from XVII where the intervals are sufficiently large to be detected by the unaided eye. If we compare XVII with VI, we see the marked effect due to the individual plate, the second negative beginning at over 110 minutes in one case and at about 60 minutes in the other case.

The general results of this paper are :

1. If a second positive exists, it requires a very long exposure even with a very bright light.
2. In many cases a false first positive or a false mongrel may be obtained.
3. Since the emulsion on an ordinary plate is probably never homogeneous, one really observes a combination solarization curve.
4. The inhomogeneity of the emulsion may easily be the cause of the false positives or of the false mongrels.
5. With long exposures we find great differences between different boxes of the same make of plates and we even find some differences between the plates in the same box.

This investigation was suggested by Professor Bancroft and has been carried out under his direction.

*Cornell University*

ON THE POLYMERIZATION OF LIQUIDS AND A GENERAL METHOD FOR DETERMINING ITS RELATIVE VALUE<sup>1</sup>

BY M. M. GARVER

In a recent paper<sup>2</sup> presented before the Royal Society of Canada at its May meeting, 1912, I applied a new molecular thermodynamic theorem to test, theoretically, the degree of polymerization of liquid substances. The dynamic basis of the theorem independent of its thermodynamic implications may be concisely stated as follows:

*The attractive forces which maintain a substance in the free liquid phase are just numerically equal to the pressure the same substance would exert, were it a perfect gas, at the same temperature and density.*

The thermodynamic significance of this theorem lies in its furnishing the force function which may be applied in all isothermal changes of phase between liquid and vapor. From the fundamental equation for work,  $W = \int_1^2 F ds$ , we may always, theoretically, find the heat equivalent of the work when  $F$  can be expressed as a function of  $s$  the displacement. When this function is expressed in terms of pressure and volume the above theorem leads directly to the conclusion that

$$\int_1^2 P dv = K \int_1^2 \frac{dv}{v}$$

which follows because it implies that the force, whether attractive, or exerting a pressure, is always proportional to the number of molecules acting on, or through, unit area. If we ignore the difference in sign which alone distinguishes an

<sup>1</sup> A paper read before the Physical Chemistry Section of the Eighth International Congress of Applied Chemistry.

<sup>2</sup> Jour. Phys. Chem., 16, 454 (1912).

attraction from a pressure, the force function is the same as that of the pressure exerted by a perfect gas. A number of experimental facts and theoretical reasons were advanced to establish the validity of the theoretical applications made. For details the former papers<sup>1</sup> may be consulted. However, there is another aspect of the theorem to which attention never has been directed, so far as the writer is aware; but as it has special significance in connection with polymerization as the fundamental source of liquid stability it should be considered in connection with estimates of the degree of polymerization.

#### Polymerization and Liquid Stability

Probably the first impression made on most minds by the bare statement of the equality of the attractive and pressure relation of molecules contained in the above dynamical theorem is one of *instability*. If the forces are so delicately balanced whence comes the liquid stability with which we are all familiar? Why should the forces be just equal and not more or less? In a vague sort of way the molecules are generally regarded as held by some powerful attraction represented by thousands of atmospheres. It is perfectly evident on reflection that the whole attraction cannot exceed the sum of its parts or that the attraction per unit area cannot exceed the sum of the pressures of the separate molecules acting in *one direction* through any element of area. The tension in a spring is measured by the pull on *one* end and not by the sum of the pulls on the two ends. Likewise the force should be measured by the rate of change of momentum *normal to one side* of an element of area. This is what we call pressure and is what we should regard as the attraction also, since it is just sufficient to neutralize any pressure in the opposite direction. This view leads to the preceding theorem. The mathematically inclined may also doubtless reach the same conclusion through the application of d'Alembert's principle to a system of free molecules in motion.

<sup>1</sup> Loc. cit.

### The Source of Liquid Stability

Since the molecular forces in a free liquid must be in a state of equilibrium and all the molecules are relatively in motion with the same average speed of translation that they would have at that temperature were they perfectly gaseous, it is at once obvious that any *greater* force than that specified in the theorem would drive at least some of the molecules into contact, or union, and thus destroy their *relatively free motion*. It is also obvious that any *less* attractive force than that just sufficient to hold the molecules at the proper average distance would allow at least some molecules to escape and thus *cool* the remaining liquid. Let us call the union of two or more exactly similar molecules to form one, polymerization and the heat given out by the union, the heat of polymerization. (Since by Maxwell's law the average kinetic energy of translation is independent of the mass, such union must either increase the average energy per molecule of the system, or the system must give out heat.) With this in mind the part played by the polymerization in producing stability in the phase equilibrium is manifest. The union, or coalescence, of molecules must *raise* the average temperature of the remaining molecules and the escape of free vapor molecules must *lower* the average temperature by permitting additional molecules to de-polymerize. In consequence of this relation of polymerization to heat, the *stability* of the system of balanced forces which would otherwise be unstable, is maintained, so that the actual number of molecules can be disturbed, or changed, only by a transfer of energy in the form of heat or work to, or from, the liquid. *The polymerization thus performs the function of a "source and sink" of heat energy and renders possible a stable equilibrium of freely moving independent molecules acted on by attractive forces, without the intervention of any hypothetical repulsion.*

### Resolution of the Heat of Vaporization into Components

During an isothermal change of phase from the vapor to the liquid phase, heat must be removed from the system

of molecules in order to permit of the change. This heat, as we have seen, may consist of two parts, *first*, the heat of polymerization due to the decrease in the number of molecules, and *secondly*, the heat equivalent of the work due to all the forces acting during the process. It is easily seen that these two separate sources of the heat of vaporization,  $L$ , may be regarded separately and treated as independent of each other provided we are able to estimate the work due to the forces concerned. This we are able to do in the case of isothermal processes, by applying the theorem previously given, since the force at any instant depends upon the number of free molecules independent of polymerization. (The "force" is to be understood as independent of whether due to an external pressure or internal attraction.) Suppose we have  $N$  molecules occupying a volume  $V$  at a temperature  $T$ . Now suppose the volume to be decreased isothermally during which the heat  $L$  is given out and the combined external and internal forces do the amount of work  $W$  and the number of molecules is diminished by an amount  $n$ , the  $n$  molecules uniting with others, so that the number becomes  $N-n$ . From Maxwell's law and the principle of conservation, using the same units for heat and work:

$$W + \frac{1}{2}Nm_1u_1^2 = L + \frac{1}{2}(N-n)m_2u_2^2$$

where  $L$  is the heat given out during the isothermal process. By Maxwell's law

$$\frac{1}{2}m_1u_1^2 = \frac{1}{2}m_2u_2^2 = \frac{1}{2}mu^2,$$

therefore

$$L - W = \frac{1}{2}nmu^2 = H \therefore L = W + H$$

where  $H$  is the heat of polymerization due to the decrease in the number of molecules occurring during the isothermal change from a vapor to a liquid.

#### A General Method of Finding the Relative Polymerization of Two Liquids

At the time the previous paper was written it was not possible for me to do more than to show that all the liquids

examined (many of which are regarded as non-associated,<sup>1</sup> or as consisting of simple vapor molecules) are, according to the present theory, considerably polymerized. For the details of the theory and method of computation the former paper may be consulted. The quantities  $H$  and  $W$  and the ratio  $r = L/W$  were found for thirteen different liquids of various different chemical types, but except in the case of water no estimate of the ratio of the weight of the liquid to the vapor molecule could be made, for no method of general application for such purpose had been found. Since then, however, further study of the subject has shown how the theory may be applied and used to determine the relative molecular weights of the liquid and vapor phases of any *other* liquid substance when these values are known for any *one* substance which may be used as a standard of comparison. In the case of water, as previously mentioned, it was possible from certain available experimental data, to make a fair estimate of the relative molecular weights of the liquid and the vapor as lying between 2.5 and 1.9 at 0° C. The minimum value, 1.9 at 0° C, agrees with the value found by van der Waals<sup>2</sup> from entirely different considerations (*i. e.*, Ramsay's values). In an early paper, W. Ramsay and J. Shields,<sup>3</sup> from surface tension experiments, found a value lying between 3 and 4; but in a later paper, Dr. Ramsay<sup>4</sup> reduced this estimate to 1.707 for water at 0° C.

For the present paper, the polymerization of water has been computed and tabulated at intervals of 20° from 0° to 200° C and will be used later as a standard of comparison in computing the relative polymerization of the remaining dozen liquids discussed in the previous paper. The method will be found to be a perfectly general one and is not necessarily confined to the use of water as a standard. When any

---

<sup>1</sup> Nernst: *Theoretische Chemie*, 6th Ed., 282 (1909).

<sup>2</sup> *Zeit. phys. Chem.*, 13, 715 (1894).

<sup>3</sup> *Ibid.*, 12, 433 (1893).

<sup>4</sup> *Ibid.*, 15, 115 (1894).

other substance becomes better known than water it may be used instead of water.

Let us consider any two substances  $S_1$  and  $S_2$  of which the molecular weights as vapor and also the values  $L$ , and  $W$  previously explained, are known. Let  $m$  represent the molecular weight of the vapor and  $m'$  the molecular weight of the liquid,  $H_1$  and  $H_2$  the heats of polymerization where  $H = L - W$ . The values  $L$  and  $H$  refer to one gram of the substance.  $Hm$  will then represent the heat of polymerization of a gram mol and must be proportional to the number of molecules that unite with others to form complex ones. Hence we have generally

$$\frac{H_1 m_1}{H_2 m_2} = \frac{n_1}{n_2} \dots \dots \dots (A)$$

The quantity we wish to find is  $\frac{m'}{m}$  which for brevity will be written  $x$ .

Since the total mass of  $n$  molecules is unchanged by polymerization we must have in the two cases

$$nm_1 = n'_1 m'_1 \text{ and } nm_2 = n'_2 m'_2$$

where  $n'$  represents the number of molecules of liquid. But

$$n - n_1 = n'_1 \text{ and } n - n_2 = n'_2$$

hence

$$n = (n - n_1) \frac{m'_1}{m_1} = (n - n_2) \frac{m'_2}{m_2}$$

By substitution and elimination we get finally

$$\frac{H_1 m_1}{H_2 m_2} = \frac{\frac{x_1 - 1}{x_1}}{\frac{x_2 - 1}{x_2}} \dots \dots \dots (B)$$

where all the quantities are supposed to be known except  $x_2$ , that is, the ratio of the weight of the liquid to the vapor molecule of the substance investigated at the specified temperature, the value of  $x_2$ , however, depending upon the value  $x_1$ , of the liquid supposed known.

The method of finding the value of  $x$  for water was

given in detail in the former paper<sup>1</sup> and need not be repeated here. The above method to be strictly applicable must be used for the same temperatures. Hence the value of  $x = \frac{m'}{m}$  for water was first found for each 20° from 0° to 200° C and tabulated in the accompanying Table I. The value of L at the different temperatures was found by applying Clausius' formula  $L = 607 - 0.7t$  as being sufficiently accurate although it probably is not very reliable for high temperatures. The specific volumes for liquid and vapor water (saturated vapor) were taken from Winkelmann,<sup>2</sup> Matthiessen's values for the liquid being used from 0° to 100° and the table of Waterston for values from 100° to 200°. Battelli's values of the specific volumes of the vapor were used except for the temperature 160° which was omitted. The value 307.3 was taken from the table of Knoblauch, Linde and Klebe (p. 997). The remaining values are taken from the author's previous paper.

TABLE I  
Polymerization of water,  $\frac{m'}{m}$  (with data)

Temp. C	Specific volumes		Calories			$\frac{m'}{m} = x$
	Liquid	Vapor	L	W	H	
0	.....	204000	607	365.6	241.4	2.11
20	1.0018	57730	593	351.7	241.3	2.02
40	1.0077	19484	579	338.2	240.8	1.93
60	1.0170	7650	565	325.5	239.5	1.86
80	1.0290	3401	551	313.3	237.7	1.80
100	1.0432	1667	537	301.5	235.5	1.75
120	1.0600	893.1	523	290.0	233.0	1.70
140	1.0795	511.4	509	278.6	230.4	1.63
160	1.1015	307.3	495	266.0	229.0	1.61
180	1.1268	197.1	481	256.2	224.8	1.57
200	1.1578	130.6	467	244.8	222.2	1.53

<sup>1</sup> Loc. cit.

<sup>2</sup> Winkelmann: Handbuch d. Physik., III, 92, 94, 996, 997.



The values of  $L$  for most substances are most accurately known at their normal boiling points; hence it is desirable to have a standard liquid covering a wide range of temperatures. Hence the utility of the water table. From the degree of accuracy at present possible it was deemed sufficient to use  $20^\circ$  intervals in the construction of the table. The entire data are given in the table in order that the theory and results may be conveniently checked by those interested.

Two illustrative examples of the method of computation will be given in some detail and the results of the computation of the remaining twelve substances will be found in the column  $\frac{m'}{m}$ . The data for the computations are included in the table under appropriate column headings.

Attention was called in the previous paper to the necessity of taking into account possible polymerization of the vapor when determining the value of  $H = L - W$  as the result measures only the *change* in the polymerization; but in case of acetic acid I failed to profit by my own warning and used the theoretical molecular weight 60 instead of the actual which is about 97 according to its vapor density. The result was a value much too low and is corrected in the present table.

Let us take ethyl alcohol as the first example. Its boiling point  $78^\circ$  is near enough to  $80^\circ$  to allow us to use the data of water at  $80^\circ$ .

Taking the necessary data from the tables we have for alcohol at  $78^\circ$

$$\frac{H_1 m_1}{H_2 m_2} = \frac{x_1 - 1}{x_2} = \frac{237.7 \times 18}{125 \times 46} = 0.744 = \frac{0.444}{x_2 - 1} \therefore x_2 = 2.48.$$

For acetic acid at  $118^\circ$  we may use water at  $120^\circ$

$$\frac{233 \times 18}{49.8 \times 97} = 0.868 = \frac{0.412}{x_2 - 1} \therefore x_2 = 1.90.$$

In this case, since the vapor was already  $1.6 \times 60$  and underwent a further increase of 1.9, the total increase or actual liquid molecule is  $1.6 \times 1.9 = 3.1$ .

The following table gives data and values of  $\frac{m'}{m}$  for all the substances for which I could obtain the necessary experimental data:

TABLE II

Substance	Temp. C	Calories			Mol. wt.	$\frac{m'}{m}$
		L	W	H		
Benzene	80	93.5	51.3	42.2	77.4	1.51
Carbon tetrachloride	20	51.1	28.6	22.5	153.7	1.61
Carbon tetrachloride	77	44.3	25.1	19.2	153.7	1.42
Carbon bisulphide	20	88.0	52.9	35.1	75.5	1.40
Ethyl ether	35	90.0	44.3	45.7	73.6	1.59
Methyl formate	31.8	110.0	60.4	49.6	59.6	1.52
Methyl propionate	79.7	89.0	44.3	44.7	87.4	1.66
Ethyl acetate	77.0	92.7	43.9	48.8	87.4	1.75
Propyl acetate	140.0	83.2	39.4	43.8	101.3	1.71
Methyl alcohol	66.0	262.0	134.0	128.0	31.8	1.78
Ethyl alcohol	78.4	216.4	91.5	124.9	46.0	2.48
Propyl alcohol	97.4	166.3	71.8	94.5	60.0	2.35
Acetic acid	118.0	97.0	47.2	49.8	97.0	1.905
Water	0	606.5	363.0	240.5	18.0	2.11
Water	100.0	537.0	300.0	237.0	...	1.75

### Conclusion

Particular attention is called to the functional part played by polymerization in maintaining equilibrium stability. The current impression that there exist immense internal pressures in liquids may conveniently be abandoned. They are dynamically impossible and otherwise serve no useful purpose. Unless we abandon entirely the Newtonian mechanics and the principle of d'Alembert the inwardly directed pressure cannot exceed the outwardly directed reaction, in a system of freely moving particles.

A very obvious objection that will no doubt be made at once by some physical chemists is, that the assumption of

the perfect gas law as the law of force is unverifiable by experiment and is "too theoretical."

The first reply to this objection should be that "the perfect gas law" actually assumed is entirely different from assuming that a given substance acts like a perfect gas or that it may be treated as a perfect gas because the internal attractions are negligible. The fundamental assumption that is made is one that is supported by the universally accepted principles of dynamics; and that is that the force of attraction which diminishes a pressure must be numerically equal, but opposite in sign, to the diminution in pressure produced by it. The *direction of the action* can have no influence on the *magnitude* of the work performed by it. So far as work is concerned it is immaterial whether it be done by a push or a pull or by a combined push and pull; and if the only effect of a pull is to diminish the push required and we know how much push would be required if there were no pull, then we may assume all push or all pull at pleasure without affecting the *computed amount* of the work due to the forces concerned. *The heat equivalent of work done by forces is entirely independent of the nature of the body upon which the work is done.*

A second reply might be: Suppose we admit that the fundamental assumptions are erroneous. Then the difficulty would be to explain the remarkable consistency of the results obtained and the practical agreement in many ways with the best results obtained by other methods. The values obtained for water are of course only a first approximation, but the *relative values* obtained also depend upon the theoretically determined heat of polymerization. This is the fundamental basis of the whole theory; and the remarkable consistency of the results obtained would be even more wonderful considered as a system of accidentally balanced errors than as the "workings of a law of Nature."

State College, Pa.,  
June, 1912

## A SUPPLEMENTARY NOTE ON A THERMODYNAMIC MEASURE OF POLYMERIZATION

BY M. M. GARVER

In a former paper<sup>1</sup> to which this note is merely supplementary, I gave an exposition of what seemed to be sufficient theoretical grounds for a thermodynamic theory of polymerization. The principal arguments were drawn from an interpretation of the following equation which will be referred to as equation (A):

$$\frac{\gamma}{2\epsilon} = \rho \frac{R}{m} \tau \dots \dots \dots (A)$$

For the origin and significance of the equation the previous papers may be consulted. The conclusions drawn from this equation, no doubt, appeared rather speculative and were not entirely satisfactory as a basis for a thermodynamic theorem; but the *applications* of the theory gave surprisingly consistent and satisfactory results. The results of the theory tended to support the theory which might be regarded as not quite established but as one which might ultimately be established. There was left in my mind, and no doubt also in that of others, a question as to the significance of the ratio  $\rho/m$ ; as to whether it had the same significance independent of polymerization. So long as this remained in doubt, *the exact* law of force could not be definitely determined; and for thermodynamic purposes this is all-important. We must know the law of force before we can determine the heat equivalent of the work due to the forces. All ambiguity may, however, be removed by an entirely different derivation of the above equation (A), so that the exact law of force is shown and the whole theory put upon a simple, indisputable, experimental, foundation.

The basis of the new treatment may be found in a fact to which I had previously called particular attention<sup>2</sup> but

<sup>1</sup> Jour. Phys. Chem., 16, 454 (1912).

<sup>2</sup> Loc. cit., p. 245.

which was unaccountably overlooked in the former paper. If this proof had occurred to me at that time the treatment of the subject would have been quite different, for we may entirely ignore the significance of  $\varepsilon$  as the "range of molecular action" and proceed *experimentally* as follows:

Suppose we measure the two ratios  $\gamma/\rho$  and  $\sigma/\omega$  experimentally, and call their product  $\tau$ , thus:

$$\frac{\gamma}{\rho} \times \frac{\sigma}{\omega} = \tau \dots \dots \dots (B)$$

Since the ratios are experimentally observed values we may substitute for  $\sigma/\omega$  another experimentally observed value in terms of  $m$  and  $RT$  so that  $m = RT \times \sigma/\omega$ . Thus  $m$  becomes an experimentally determined molecular weight. Since all the quantities entering into the equation (A) are now either directly observed, or are simple relations of observed quantities, there can be no doubt or ambiguity as to their meanings. Hence also any effects due to polymerization are eliminated because included in the observations for both liquid and vapor. We see also that exactly similar equations can be found for every liquid and its vapor entirely independently of whether it is polymerized or not. No change in the form of the equation or change in the meaning of the symbols can result from the fact that one liquid, or vapor, is polymerized and another is not. *The observed values are required.* Hence equation (A) with the above meanings of the symbols is entirely independent of polymerization, for it applies to every liquid whether polymerized or not.

Although the quantity  $\tau$  has a perfectly definite numerical value it remains to determine its physical significance. This we may readily do from equation (B) above, which may be written  $\gamma/\tau = (\rho/\sigma) \times \omega$ . From the theory of dimensions of physical quantities we find that  $\tau$  is an area; for since  $\rho$  and  $\sigma$  both represent densities their ratio is a pure number and cancels out. Therefore,  $\gamma/\tau$  is of the same dimensions as  $\omega$ , or is a force per unit area. Since  $\gamma$  represents an attraction, the last equation may be expressed in words as follows:

The ratio of the attraction per unit area of cross-section in a liquid film to the pressure per unit area exerted by the saturated vapor is equal to the ratio of the liquid density to the vapor density.

Thus without any recourse to the kinetic theory or to any theory of the molecule; without any assumptions or hypotheses beyond a simple application of the theory of dimensions used to establish the physical significance of  $\tau$ , we have established on purely experimental grounds the law of force in liquids and its relation to the law of force in vapors. Since exactly the same law, except as to sign, is found to apply to both the liquid and vapor phases of a substance, we may safely assume that it applies also to the change of phase, or, that the attractive forces which are assumed to produce a decrease in the pressure of a vapor must be numerically equal to any decrease in pressure produced by the forces.

We have then, it seems to me, a reliable, experimental basis for determining the heat equivalent of the forces acting during an isothermal change in phase; and hence that we have also a secure foundation upon which to build a thermodynamic theory of the degree of polymerization of liquid substances.

*State College, Pa.,  
Aug. 12, 1912*

# THE ACTION OF POTASSIUM AMIDE ON THALLIUM NITRATE IN LIQUID AMMONIA SOLUTIONS

BY EDWARD CURTIS FRANKLIN

## Introduction

During the academic year 1910-11 Mr. T. B. Hine, working in the chemical laboratory of the Leland Stanford Junior University, undertook an investigation of the products formed by the interaction of potassium amide and thallium salts in solution in liquid ammonia, as a result of which it was hoped to add another metal derivative in the form of an amide, imide or nitride of thallium, to the list of new basic compounds belonging to the ammonia system of acids, bases and salts.<sup>1</sup> Hine found that a black precipitate was formed when he poured a solution of potassium amide into liquid ammonia solutions of thallium nitrate, but more interesting than this was the observation that an excess of potassium amide dissolves the black precipitate forming a golden yellow solution from which, either by cooling or evaporating off a portion of the solvent, beautiful, yellow crystals are deposited. In view of the moderate solubility of the substance and of its crystalline character it was assumed that the isolation of the compound and the establishment of its composition would be a comparatively simple matter; but, for reasons which will appear, our expectations in this respect were not realized. In the first place, both the black precipitate and the soluble yellow compound are not only powerfully explosive but they are at the same time, in the dry state, very sensitive to shock or the action of water or dilute acids. As a result of this instability, many specimens of the yellow compound were lost before they could be decomposed and their decomposition products got into aqueous solution preparatory to analysis. In the second place, the analysis of preparations which had

<sup>1</sup> For an exposition of the writer's theory of an ammonia system of acids, bases and salts, cf. *Am. Chem. Jour.*, 47, 285 (1912).

every appearance of being pure compounds gave most discordant results; but a single one of more than a dozen analyses showing the constituent elements, thallium, nitrogen and potassium, to be present in atomic proportions. Specimens of apparently the same well-crystallized compound, prepared by the action of potassium amide on thallium iodide, gave no more concordant results than those prepared from thallium nitrate. Nor were better analytical results obtained when the black precipitate, assumed to be the amide, imide or nitride of thallium, was washed to free it from the potassium nitrate which was supposed to be a product of the action of potassium amide on the thallium salt, before it was dissolved in potassium amide.

The writer has continued the work which Hine was forced to abandon at the end of his year of work and has found that the black precipitate is a nitride of thallium of the formula  $Tl_3N$ , that a definite compound of the composition represented by the formula  $TlNK_2 \cdot 4NH_3$  may be obtained by the action of potassium amide on thallium nitride in excess, and that the numerous preparations obtained by Hine must be looked upon as isomorphous mixtures of this compound, or of thallium amide, with potassium amide.

#### Thallium Nitride, $Tl_3N$

*Preparation.*—Appropriate quantities of thallium nitrate and metallic potassium are introduced respectively into the two arms of the reaction tube and brought into solution in liquid ammonia in the manner described in detail in previous papers.<sup>1</sup> After the conversion of the metallic potassium into potassium amide, the solution of the latter is poured into the solution of thallium nitrate until practically all of the thallium is separated from the solution in the form of a black precipitate, care being taken to avoid adding an excess of the precipitant. The black precipitate is then washed, dried, carefully hydrolyzed by the action of water vapor and removed

<sup>1</sup> Jour. Am. Chem. Soc., 27, 820 (1905); 29, 656, 1693 (1907). Jour. Phys. Chem., 15, 509 (1911).



from the preparation tube for analysis after the manner described in the papers above cited. It may be stated that notwithstanding the exercise of great care in carrying out these operations—more especially those involving the manipulation of the dry compound—a considerable number of experiments ended in violent explosions.

*Analysis.*—The products of the hydrolysis of the black compound were dissolved in dilute sulfuric acid, thus giving an aqueous solution of the sulfates of thallium and ammonium. The ammonia contained in this solution was determined by the usual volumetric method, the thallium in the form of thallos iodide or sulfate. The following analytical data were obtained: Preparation I: One half of 0.6100 gm of the substance gave 0.3480 gm  $Tl_2SO_4$ , the other half gave ammonia equivalent to 0.0078 gm N. Preparation II: One half of 0.3436 gm of the substance was found to contain 0.1654 gm Tl, the other half gave ammonia equivalent to 0.00384 gm N. Preparation III: One half of 0.4735 gm substance was found to contain 0.2315 gm Tl, the other half gave ammonia equivalent to 0.00532 gm N.

	Calculated for $Tl_3N$	Found		
		I <sup>1</sup>	II	III
Tl	97.8	92.5	96.4	97.8
N	2.2	2.6	2.2	2.2

Thallos nitride is thus shown to be the product of the action of potassium amide upon thallium nitrate in solution in liquid ammonia. It is formed in accordance with the equation

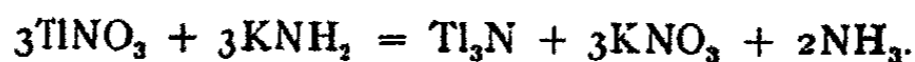

*Properties.*—Thallium nitride is obtained as a dense, black precipitate which settles well, and which remains in

<sup>1</sup> This preparation, by Hime, was found to contain 3.9 percent of potassium nitrate. Thallium losses are known to have occurred due to too strong ignition of thallium sulfate.

the bottom of the reaction tube in the form of black, amorphous lumps when the ammonia is evaporated away. There was no evidence of the formation of an amide or imide of thallium either at laboratory temperature or at  $33^{\circ}$  below zero. It dissolves readily in liquid ammonia solutions of ammonium nitrate or of potassium amide and, in consequence, must be assumed to be amphoteric in character. It explodes with violence when heated or subjected to shock, or when brought into contact with water or dilute acids. In contact with water vapor it undergoes hydrolysis.

**Potassium Ammonothallite,  $TlK_2 \cdot 4NH_3$ ,  $TlK_2 \cdot 2NH_3$ , and  $TlK_2 \cdot 1\frac{1}{2}NH_3$**

As has been stated in the introduction to this paper a solution from which it is easy to separate a crop of well-formed crystals is obtained when thallic nitride is treated with a liquid ammonia solution of potassium amide. Experience has shown, however, that in general these crystals are of indefinite composition; that it is only by repeated recrystallization or, much more conveniently, by crystallization from solutions which have stood in contact with an excess of thallium nitride that a definite compound is obtained.

*Preparation.*—The preparation of potassium ammonothallite is carried on in a three-legged tube described in an earlier paper<sup>1</sup> in the following manner: Into one of the three legs of the reaction tube a known quantity of thallium nitrate is introduced, into the second a quantity of metallic potassium—together with a milligram or less of platinum black—sufficient to give an amount of potassium amide approximately equivalent to the thallium nitrate, and in the third leg somewhat less than two equivalents of metallic potassium together again with a small quantity of platinum black. After closing the open ends of the three legs closed before the blowpipe, ammonia is distilled into the reaction tube, which is then set aside until the metallic potassium is converted into potassium amide. The ammonia is then distilled out of the

<sup>1</sup> Loc. cit.

leg containing the two equivalents of potassium amide, thus leaving this material in the form of a dry mass clinging to the lower walls and bottom of this leg of the reaction tube. The operations of precipitating and washing the thallium nitride are then carried out without danger of admixture with this reserve potassium amide. After thoroughly washing the precipitate, a portion of the solvent is distilled from the washings into the leg containing the reserve potassium amide, and the solution formed is poured upon the pure thallium nitride which dissolves to a yellow solution of potassium ammonothallite. The leg containing the residue from the wash liquid is then detached from the reaction apparatus by sealing off before the blow pipe, thus leaving a two-legged tube containing the yellow solution together with some undissolved thallium nitride and the small quantity of platinum black introduced at the beginning of the experiment. The solution is freed from the platinum black and the undissolved thallium nitride by simply pouring the solution off the black residue into the second leg of the reaction tube. The leg containing the insoluble impurities is then sealed off at half of its length thus removing these impurities entirely and at the same time shortening this leg to a more convenient length for the operation of crystallizing the salt. By adjusting the solution, contained now in the shortened leg, to the proper concentration it is easy to obtain a crop of beautifully developed crystals of the yellow salt by simply immersing the apparatus in an ice bath. The mother liquor is then poured off the crop of crystals into the second leg of the apparatus. Ammonia is distilled back upon the crystals in sufficient quantity to dissolve them at a temperature somewhat above that of the laboratory but not high enough to endanger the reaction tube as the result of too great internal pressure, when, on cooling, a crop of crystals is again obtained. By repeating the operations thus described the substance may be recrystallized as many times as the quantity of material and the other exigencies of the necessary operations will permit. The reaction tube is then sealed apart at the bend, thus removing

the mother liquor and leaving the preparation contained in a receptacle<sup>1</sup> of convenient form for determining ammonia of crystallization and for weighing preparatory to analysis.

*Methods of Analysis.*—Such ammonia as is readily given off by warming the preparation or by lowering the gas concentration in contact with the salt was determined by a method already described.<sup>2</sup> Preparatory to analysis the dried salt—that is to say, the salt freed from liquid ammonia and such ammonia of crystallization as is given off under the chosen conditions of temperature and pressure—is hydrolyzed by the action of water vapor, dissolved in dilute sulfuric acid and removed from the specimen tube in accordance with the procedure described in the paper to which reference has just been made. The aqueous solution thus obtained contains the nitrogen of the original compound in the form of ammonium sulfate, the thallium as thallos sulfate and the potassium as potassium sulfate. Ammonia is determined in an aliquot part of the solution by the usual volumetric method. From another portion the thallium is precipitated as sulfide, leaving a solution which, on evaporation and ignition of the residue after the usual method, gives the potassium sulfate. The thallium sulfide is dissolved in nitric acid from which solution, after the removal of hydrogen sulfide and sulfur, the thallium is precipitated as iodide.

*Analytical Results.*—Preparation I: The specimen dried *in vacuo* at 100° weighed 0.5444 gm and was found to contain 0.3404 gm Tl, 0.0552 gm N and 0.1400 gm K. The salt dried at -40° lost 0.0795 gm NH<sub>3</sub> on heating to 100°. Preparation II: Dried *in vacuo* at 100° the specimen weighed 0.6457 gm and was found to contain 0.4041 gm Tl, 0.0661 gm N and 0.1640 gm K. The salt dried at -40° lost 0.0695 gm NH<sub>3</sub> at 50° and 0.0223 gm NH<sub>3</sub> additional at 100°. Preparation III: Dried at 110° the specimen weighed 0.8041 gm and was found to contain 0.5076 gm Tl, 0.0819 gm N and 0.2062 gm K. The salt dried at -40° lost 0.0821 gm NH<sub>3</sub> at 60° and 0.0297

<sup>1</sup> Jour. Phys. Chem., 15, 515 (1911).

<sup>2</sup> Ibid., 15, 509 (1911).

gm  $\text{NH}_3$  additional at  $110^\circ$ . Preparation IV: During the operation of washing the thallium nitride the contents of all three legs of the reaction apparatus were inadvertently mixed, thus giving a solution containing all the potassium nitrate formed in the reaction. Notwithstanding the presence of this potassium nitrate three recrystallizations of the yellow salt gave a satisfactorily pure product. The specimen dried at  $100^\circ$  weighed 0.6288 gm and was found to contain 0.3984 gm Tl, 0.0651 gm N and 0.1575 gm K. The salt dried at  $-40^\circ$  lost 0.0650 gm  $\text{NH}_3$  at  $22^\circ$ , and 0.0315 gm  $\text{NH}_3$  additional at  $100^\circ$ . Preparation V: In this experiment the thallium nitride from four grams of thallium nitrate was dissolved in five equivalents of potassium amide, thus forming a solution from which it was expected that a compound richer in potassium than the salt represented by the formula  $\text{TlNK}_2 \cdot 4\text{NH}_3$  would be obtained. Contrary to expectations, however, the results of the analysis show that this experiment gave the purest specimen of potassium ammonothallite obtained during the whole course of this investigation. The purity of this specimen is due to the fact that it was recrystallized four times from solutions as dilute as they could be made and still permit the separation of a final specimen large enough for analysis. The specimen dried at  $20^\circ$  weighed 0.8041 gm and was found to contain 0.4962 gm Tl, 0.1045 gm N and 0.1916 gm K.

Tabulated herewith are given, first, the percentage composition of four specimens of the salt dried *in vacuo* at  $100^\circ$ , and, second, the amount of ammonia lost by drying the yellow crystalline compound at  $20^\circ$  to  $60^\circ$  and at  $100^\circ$  to  $110^\circ$ , respectively, expressed in percentages of weight of the dried compound:

	Calculated for $\text{TlNK}_2 \cdot 1\frac{1}{3}\text{NH}_3$	Found			
		I	II	III	IV
Tl	64.0	62.6	62.5	63.1	63.5
N	10.2	10.1	10.2	10.2	10.3
K	24.5	25.8	25.4	25.6	25.1

	Calculated for $2\frac{2}{3}$ and $2\frac{1}{3}$ NH <sub>3</sub>	Found			
		I	II	III	IV
2NH <sub>3</sub>	10.7	—	10.7	10.2	10.3
$\frac{2}{3}$ NH <sub>3</sub>	3.6	—	3.5	3.7	5.0
$2\frac{2}{3}$ NH <sub>3</sub>	14.3	14.6	—	—	—

The percentage composition of one specimen of salt dried *in vacuo* at 20° follows:

	Calculated for TlNK <sub>2</sub> .2NH <sub>3</sub>	Found V
Tl	61.8	61.8
N	12.7	13.0
K	23.7	23.8

These analytical results show, first, that the yellow, crystalline product of the action of potassium amide on thallium nitride when dried at low pressure at  $-40^{\circ 1}$  is to be represented by the formula TlNK<sub>2</sub>.4NH<sub>3</sub>; second, that when this compound is heated *in vacuo* to laboratory temperature it loses two molecules of ammonia, thus giving the compound of the formula TlNK<sub>2</sub>.2NH<sub>3</sub>; and third, that on further heating to 100° the latter compound loses two-thirds of a molecule of ammonia to give a product the composition of which is represented by the formula TlNK<sub>2</sub>.1 $\frac{1}{3}$ NH<sub>3</sub>.

The action of potassium amide on thallos nitride is represented by the equation:



*Properties of Potassium Ammonothallite.*—The salt is obtained from its solutions in liquid ammonia in the form of beautiful, yellow crystals which are moderately soluble at 20°, considerably more soluble at somewhat higher tempera-

<sup>1</sup> This is the approximate temperature which the bath of liquid ammonia used takes on when left open to the atmosphere. Means for adjusting and measuring the temperature of the ammonia bath were not at hand during this work.

tures and distinctly less soluble at lower temperatures. The yellow salt readily loses ammonia, showing the phenomenon of efflorescence even at  $-40^{\circ}$  when the concentration of the ammonia gas in contact with the salt is kept sufficiently low. Some of the specimens dried at  $20^{\circ}$  showed a uniform light yellow color, others were considerably discolored. The salt is extremely sensitive to the action of air or moisture; even traces of air gaining entrance to the containing tube produces a blackening of the preparation. It explodes violently when brought into contact with water or dilute acids. Heated to  $100^{\circ}$  the yellow salt is converted into a black mass, which, if the temperature is maintained gradually, gives off nitrogen gas, metallic thallium being set free at the same time. At somewhat higher temperature the compound explodes. Percussion also determines the explosion of the yellow salt or its deammonation products; even so mild a blow as the falling of the tube containing the salt through a few feet upon a wooden floor invariably results in a violent explosion. It is decomposed by liquid ammonia solutions of acids; ammonium nitrate, for example, added to a solution of potassium ammonothallite converts the salt first into thallos nitride which latter, on further addition of ammonium nitrate, goes into solution as thallos nitrate. These reactions are represented by the equations:

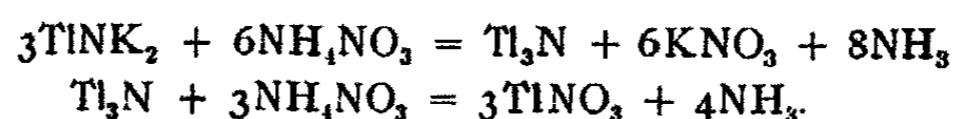

Exposed to the action of water vapor the salt is hydrolytically decomposed, giving thallos hydroxide, potassium hydroxide and ammonia as the products of hydrolysis. The salt undergoes gradual decomposition, with deposition of spongy metallic thallium, on standing in contact with liquid ammonia solution, especially in the presence of light. As will be discussed in some detail below, the yellow salt forms isomorphous mixtures with potassium amide, a property which probably explains the low results for thallium and high results for potassium as found in most of the above recorded analyses.

*The Constitution of Potassium Ammonothallite.*—Following the accepted theory of the constitution of the alkali metal salts of such amphoteric hydroxides as zinc hydroxide, lead hydroxide, etc., the formulas  $Zn(NHK)_2 \cdot 2NH_3$ ,  $PbNK_2 \cdot 1\frac{1}{2}NH_3$ ,  $Sn(NK)_2 \cdot 4NH_3$  and  $TlNK_2 \cdot 4NH_3$  and the respective names dipotassium ammonozincate, potassium ammonoplumbite, dipotassium ammonostannate and dipotassium ammonothallite have been given to the analogous salts of the ammonia system. It has been pointed out, however, in connection with the account of the preparation of the zinc,<sup>1</sup> tin<sup>2</sup> and lead<sup>3</sup> compounds that, instead of formulating these compounds as ammono salts with ammonia of crystallization, they may also be represented as molecular compounds of potassium amide with the amide or imide of the less positive metal. The zinc compound may accordingly be given the formula  $Zn(NH_2)_2 \cdot 2KNH_2$ ; the tin compound the formula  $Sn(NH_2)_4 \cdot 2KNH_2$ ; and the lead compound either of the two formulas,  $PbNH \cdot KNH_2 \cdot 1\frac{1}{2}NH_3$  or  $Pb(NH_2)_2 \cdot KNH_2 \cdot \frac{1}{2}NH_3$ . Similarly, the tetrammonated potassium ammonothallite may be formulated as a molecular compound of thallium amide, potassium amide and ammonia,  $TlNH_2 \cdot 2KNH_2 \cdot 2NH_3$ , and its first deammonation product may be given the formula  $TlNH_2 \cdot 2KNH_2$ . The second deammonation product can not of course be formulated as a molecular compound of the metallic amides. It is interesting, however, to note that while the fractional coefficient has no obvious significance when the final deammonation product of the yellow salt is given the formula  $TlNK_2 \cdot 1\frac{1}{3}NH_3$ , it finds a plausible explanation when the loss of ammonia by the compound represented by the formula  $TlNK_2 \cdot 2NH_3$  is assumed to result from the conversion of thallium amide into thallium nitride in accordance with the equation:



<sup>1</sup> Jour. Am. Chem. Soc., 29, 656, 1274 (1907).

<sup>2</sup> Ibid., 29, 1693 (1907).

<sup>3</sup> Jour. Phys. Chem., 15, 509 (1911).

<sup>4</sup> In this connection it is interesting to recall the experiments on the deammonation of the analogous zinc, tin and lead compounds. A specimen of



It is not at all certain that the product represented by the formula  $Tl_3N.6KNH_2$  is a definite chemical compound; its black color and its behavior toward liquid ammonia suggests the possibility that we may have here to do with a mixture of thallium nitride and potassium amide.

It is, of course, also possible to formulate these ammonio salts as molecular compounds of the two metallic nitrides and ammonia just as certain aquo salts, the aluminates,<sup>1</sup> for example, in terms of the old dualistic theory, are sometimes formulated as molecular compounds of the acid and basic oxides and water. Omitting the tin, zinc and lead compounds from consideration, it will be sufficient to give the formulas  $Tl_3N.2K_3N.12NH_3$ ,  $Tl_3N.2K_3N.6NH_3$  and  $Tl_3N.$

potassium ammonozincate [Jour. Am. Chem. Soc., 29, 1274 (1907)] of the formula  $Zn(NHK)_2.2NH_3$  when heated to  $250^\circ$  was found to lose 11.3 percent ammonia. A second specimen heated to  $300^\circ$  lost 11.6 percent. At the time this work was done it seemed probable that the loss of ammonia resulted in the formation of a compound of the formula  $Zn(NHK)_2.1/2NH_3$  which would require a loss of 12.3 percent ammonia. The experimental results, however, are in considerably better agreement with the assumption that the deammonation takes place in accordance with the equation  $Zn(NHK)_2.2NH_3 = Zn(NHK)_2.2/3NH_3 + 1/3NH_3$  which requires a loss of 10.9 percent ammonia on the part of the crystallized salt. If this equation be assumed to correctly represent the deammonation of potassium ammonozincate, then the experimentally determined loss of ammonia in excess of 10.9 percent may be explained as resulting from the interaction of the fused salt and the glass of the containing tube [l. c.]. These experimental data make plausible the interpretation of the loss of ammonia by the crystallized potassium ammonozincate as the result of the deammonation of zinc amide into zinc nitride in the manner represented by the equation  $3(Zn(NH_2)_2.2KNH_2) = Zn_3N_2.6KNH_2 + 4NH_3$ , which reaction is seen to be analogous to that brought about by heating potassium ammonothallite.

Potassium ammonoplumbite [Jour. Phys. Chem., 15, 509 (1911)] may be similarly represented as a molecular compound of lead amide, potassium amide and ammonia,  $Pb(NH_2)_2.KNH_2.1/2NH_3$ , which upon deammonation gives first the compound of the formula  $Pb(NH_2)_2.KNH_2$  which in turn loses ammonia to give a compound of the formula  $PbNH.KNH_2$ . Any further possible deammonation of lead imide to form lead nitride can not be realized for reason that the compound explodes at a temperature slightly above that at which it is formed from the compound  $Pb(NH_2)_2.KNH_2$ .

The experimental determination of the amount of ammonia evolved on heating potassium ammonostannate will not permit a similar interpretation of the deammonation of this salt [Jour. Am. Chem. Soc., 29, 1694 (1907)].

<sup>1</sup> *Traité de Chim. minérale* (Moissan), 4, 56 (1905).

$2K_3N \cdot 4NH_3$  for the three thallium compounds to show just what is meant.

**Isomorphous Mixtures Resulting from the Action of Potassium Amide on Thallous Nitride**

When thallium nitride is dissolved in liquid ammonia solutions of potassium amide without special precautions being taken to avoid an excess of potassium amide, or, having dissolved the nitride in excess of the amide, without somewhat elaborate fractional recrystallization of the yellow salt, it has been found that the well-crystallized, apparently homogeneous products obtained are of widely varying composition.

Nine preparations by Hine, for example, together with a number of specimens obtained during the earlier attempts made in this laboratory to find an explanation of Hine's results, showed a variation in thallium content ranging from less than 34 percent up to 58.2 percent and in no case were thallium, nitrogen and potassium present in these preparations in atomic ratios. There seems to be but one way, certainly but one obvious way, of explaining such results, and that is to assume the yellow, crystalline products to be isomorphous mixtures or solid solutions, of some two or more chemical individuals. What the constituents of these mixed crystals are, however, can not be stated with any degree of certainty. Some discussion of this question is given in later pages of this article.

In order to determine in a systematic manner the influence of an excess of potassium amide upon the composition of the yellow salt deposited from solutions formed by dissolving thallous nitride in liquid ammonia solutions of potassium amide, four attempts were made to carry through the following described experiments, only the last one of which, however, was successfully completed.

Operations are begun by introducing—after the manner described in earlier papers<sup>1</sup>—a weighed quantity of thallium

<sup>1</sup> Jour. Am. Chem. Soc., 28, 830 (1905); 29, 650, 1274, 1693 (1907). Jour. Phys. Chem., 15, 509 (1911).

nitrate into leg A, an equivalent amount of metallic potassium into leg B and a determined number of equivalents of metallic potassium into leg C of the apparatus shown in Fig. 1. Liquid ammonia is then distilled into the apparatus through one of the stopcocks in quantity sufficient for carrying out the subsequent operations. After the metallic potassium has been converted into the amide the solvent is evaporated completely from leg C, thus leaving a dry residue of potassium amide which is reserved for later use. The preparation of pure thallos nitride is accomplished by pouring the potassium amide solution from leg B into the thallium nitrate solution contained in leg A and washing the black precipitate the requisite number of times by decantation. Leg A now contains pure thallium nitride while leg B contains potassium

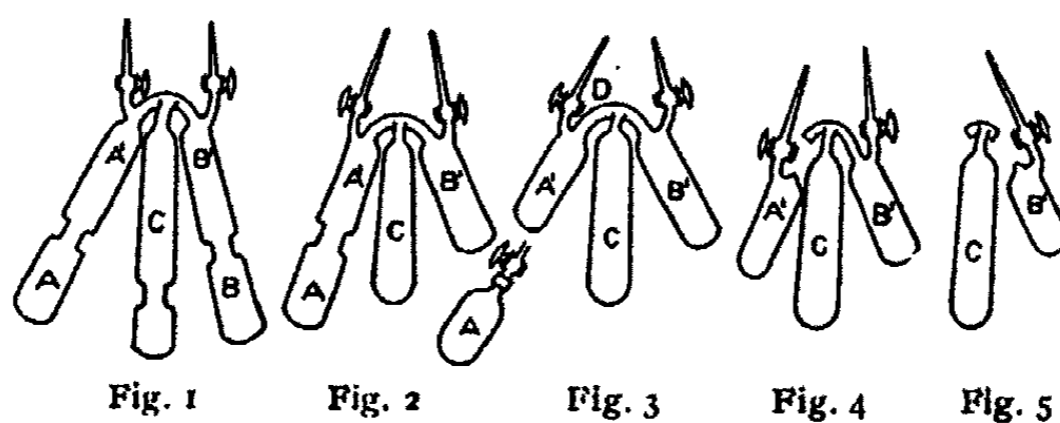

nitrate together with a slight excess of either thallium nitrate or potassium amide. With all the liquid in the apparatus distilled into leg A the residue from the washings is removed from the apparatus by sealing leg B off at the constriction. The reserve potassium amide contained in leg C is then dissolved in liquid poured over from leg A and the solution formed is transferred to the leg containing the thallium nitride. The nitride dissolves readily to a clear, yellow solution, which is transferred to leg C where the platinum black and other impurities are allowed to subside. The supernatant solution is then poured back into leg A and leg C, after washing it clean of all soluble salt, is sealed off at the constriction, thus removing the platinum black and other insoluble impurities from the apparatus together with the piece of glass tubing used as a container for introducing the metallic potas-

sium into the leg of the apparatus. From the solution contained in the apparatus three crops of crystals are obtained as follows: From the solution of proper concentration contained in leg A (Fig. 2), the deposition of a homogeneous crop of crystals is brought about by cooling this leg by immersion in ice water. The mother liquor is then poured off the crystals into leg C and, after washing with small quantities of liquid ammonia distilled over from leg C, or after recrystallizing the desired number of times, the lower portion of tube A is detached from the rest of the apparatus by sealing off at the constriction, thus accomplishing the isolation of the first crop of crystals. Following the procedure just described a second crop of crystals is obtained in the shortened leg A' (Fig. 3), which is then removed by sealing the tube off at the constriction D. A second fraction is thus isolated contained in a specimen tube similar to tube A excepting that the stopcock of the former is attached by means of a piece of rubber tubing tied on by means of a piece of wire instead of being sealed on as in the latter case. A third crop of crystals is deposited in leg B' (Fig. 4) which is in turn separated from leg C, leaving in the latter container the final mother liquors (Fig. 5). The procedure followed in removing substances of this kind from their containers and the methods pursued in their analysis have already been described.<sup>1</sup>

Accounts of the individual experiments are given herewith in such detail as clearness requires.

Experiment 1. The first fraction obtained in this experiment has already been described as preparation V above.<sup>2</sup> The explosion of the reaction tube entailed the loss of the mother liquor from this preparation.

Experiment 2. Preparation IIa, IIb, IIc: Into the three legs of the reaction tube were introduced, respectively, 3 gm  $TiNO_3$ , 0.44 gm K and 2.20 gm K. The first fraction after three recrystallizations was found upon analysis to be the compound  $TiNK_{7.4}NH_3$  with but little admixture of po-

<sup>1</sup> Loc. cit.

<sup>2</sup> Page 688.

tassium amide. It seems certain, therefore, that this compound may be separated from solutions containing a large excess of potassium amide by repeated recrystallizations from pure solvent. It will be remembered that preparation V above was obtained from a solution containing five equivalents of potassium amide to each equivalent of thallium nitride. The first fraction dried *in vacuo* at 100° weighed 0.8545 gm and was found to contain 0.5394 gm Tl, 0.0844 gm N and 0.2221 gm K. The specimen dried at -40° lost 0.0843 gm NH<sub>3</sub> at laboratory temperature and 0.0397 gm NH<sub>3</sub> additional at 100°. The second fraction was accidentally lost. The third fraction recrystallized three times and dried *in vacuo* at 100° weighed 0.2957 gm and was found to contain 0.1222 gm Tl, 0.0455 gm N and 0.1203 gm K. The specimen dried at -40° lost 0.0196 gm NH<sub>3</sub> at 26°, and 0.0112 gm NH<sub>3</sub> additional at 100°.

Experiment 3. Preparations IIIa, IIIb, and IIIc: A repetition of the above experiment using the same amounts of thallium nitrate and metallic potassium<sup>1</sup> gave a first crop of crystals which, recrystallized but once and dried *in vacuo* at laboratory temperature, weighed 0.5755 gm and was found to contain 0.3147 gm Tl, 0.0807 gm N and 0.1544 gm K. The loss of ammonia between -40° and +20° was 0.0587 gm. Neither this nor any of the succeeding specimens were heated to 100°. The second crop of crystals was not recrystallized but was washed twice with small quantities of pure solvent distilled over from the second arm of the reaction tube. Dried *in vacuo* at 20° the specimen weighed 0.6303 gm and was found to contain 0.3227 gm Tl, 0.0955 gm N and 0.2034 gm K. Between -40° and +20° the specimen lost 0.0530 gm NH<sub>3</sub>. The third crop of crystals was lost by the explosion of the containing tube.

<sup>1</sup> It is worth while to note that the salt in solution in the wash liquid from thallium nitride and formed by the interaction of thallium nitrate and potassium amide has frequently been tested qualitatively and found to be potassium nitrate. In this experiment the wash liquid was evaporated away and the residue weighed. Three grams of thallium nitrate should furnish 1.140 grams KNO<sub>3</sub>; the observed weight of the residue was 1.127 grams.

Experiment 4. Preparations IVa, IVb, IVc, IVd: A fourth experiment was successfully completed in accordance with the procedure described above. Two grams of thallium nitrate, with one equivalent of potassium amide in the second leg of the apparatus and 5.6 equivalents in the third, were used. None of the three crops of crystals were recrystallized but were freed from the mother liquor by washing several times with small quantities of pure solvent. The first fraction dried *in vacuo* at 20° weighed 0.5714 gm and was found to contain 0.2953 gm Tl, 0.0874 gm N and 0.1729 gm K. The specimen dried at -33° lost 0.0455 gm NH<sub>3</sub> on warming to 20°. The second fraction dried *in vacuo* at 20° weighed 0.9765 gm and was found to contain 0.4085 gm Tl, 0.1656 gm N and 0.3731 gm K. The ammonia retained on drying at -40° was not determined. The third portion dried *in vacuo* at 20° weighed 0.7170 gm and was found to contain 0.2730 gm Tl, 0.1367 gm N and 0.2958 gm K. This specimen dried at -33° lost 0.0465 gm NH<sub>3</sub> at 20°. It was not convenient to determine the weight of the residue from the final mother liquor; its percentage composition, however, was determined.

The results of the above experiments are summarized in Table I. In column I are given the designations of the preparations. In column II, the percentage composition of each preparation dried *in vacuo* at 20°, is given together with the amount of ammonia lost between -40° and +20° expressed in percentages of the weight of the salt dried at 20°. In column III are given the atomic ratios between thallium, nitrogen contained in the compound at 20°, potassium, and nitrogen given off as ammonia between -40° and +20°. In column IV the product obtained by drying at 20° is formulated, first, as a mixture of the compound TlNK<sub>2</sub>.2NH<sub>3</sub> with potassium amide and, second, simply as a mixture of thallium amide and potassium amide. In column V the product obtained by drying at -40° is formulated, first, as a mixture of the compound TlNK<sub>2</sub>.4NH<sub>3</sub> with potassium amide and, second, as a mixture of thallium amide and potassium amide containing variable

TABLE I

I	II	III	IV	V
IIa	Tl 60.5 N 13.2 K 24.8 NH <sub>3</sub> 9.4	1.0 3.17 2.14 1.87	TlK <sub>2</sub> .2NH <sub>3</sub> + 0.1KNH <sub>2</sub> TlNH <sub>2</sub> + 2.1KNH <sub>2</sub>	TlK <sub>2</sub> .4NH <sub>3</sub> + 0.1KNH <sub>2</sub> - 0.1NH <sub>3</sub> TlNH <sub>2</sub> + 2.1KNH <sub>2</sub> + 1.9NH <sub>3</sub>
IIc	Tl 39.8 N 17.8 K 39.2 NH <sub>3</sub> 6.4	1.0 6.52 5.13 1.93	TlK <sub>2</sub> .2NH <sub>3</sub> + 3.1KNH <sub>2</sub> + 0.4NH <sub>3</sub> TlNH <sub>2</sub> + 5.1KNH <sub>2</sub> + 0.4NH <sub>3</sub>	TlK <sub>2</sub> .4NH <sub>3</sub> + 3.1KNH <sub>2</sub> + 0.3NH <sub>3</sub> TlNH <sub>2</sub> + 5.1KNH <sub>2</sub> + 2.3NH <sub>3</sub>
IIIa	Tl 54.7 N 14.0 K 26.8 NH <sub>3</sub> 10.2	1.0 3.74 5.56 2.24	TlK <sub>2</sub> .2NH <sub>3</sub> + 0.6KNH <sub>2</sub> + 0.2NH <sub>3</sub> TlNH <sub>2</sub> + 2.6KNH <sub>2</sub> + 0.2NH <sub>3</sub>	TlK <sub>2</sub> .4NH <sub>3</sub> + 0.6KNH <sub>2</sub> + 0.4NH <sub>3</sub> TlNH <sub>2</sub> + 2.6KNH <sub>2</sub> + 2.4NH <sub>3</sub>
IIIb	Tl 51.3 N 15.1 K 32.3 NH <sub>3</sub> 8.5	1.0 4.25 3.27 1.98	TlK <sub>2</sub> .2NH <sub>3</sub> + 1.3KNH <sub>2</sub> TlNH <sub>2</sub> + 3.3KNH <sub>2</sub>	TlK <sub>2</sub> .4NH <sub>3</sub> + 1.3KNH <sub>2</sub> TlNH <sub>2</sub> + 3.3KNH <sub>2</sub> + 2NH <sub>3</sub>
IVa	Tl 51.6 N 14.4 K 30.2 NH <sub>3</sub> 8.0	1.0 4.06 3.05 1.86	TlK <sub>2</sub> .2NH <sub>3</sub> + 1.1KNH <sub>2</sub> TlNH <sub>2</sub> + 3.1KNH <sub>2</sub>	TlK <sub>2</sub> .4NH <sub>3</sub> + 1.1KNH <sub>2</sub> - 0.1NH <sub>3</sub> TlNH <sub>2</sub> + 3.1KNH <sub>2</sub> + 1.9NH <sub>3</sub>

TABLE I (Continued)

I	II	III	IV	V
IVb	TI 41.9 N 16.5 K 38.2 NH <sub>3</sub>	1.0 5.74 4.75	TINK <sub>2</sub> .2NH <sub>3</sub> + 2.7KNH <sub>2</sub> TINH <sub>2</sub> + 4.7KNH <sub>2</sub>	
IVc	TI 38.1 N 18.5 K 41.2 NH <sub>3</sub> 6.5	1.0 7.05 5.64 2.04	TINK <sub>2</sub> .2NH <sub>3</sub> + 3.6KNH <sub>2</sub> + 0.4NH <sub>3</sub> TINH <sub>2</sub> + 5.6KNH <sub>2</sub> + 0.4NH <sub>3</sub>	TINK <sub>2</sub> .4NH <sub>3</sub> + 3.6KNH <sub>2</sub> + 0.4NH <sub>3</sub> TINH <sub>2</sub> + 5.6KNH <sub>2</sub> + 2.4NH <sub>3</sub>
IVd	TI 23.4 N 19.8 K 52.5 NH <sub>3</sub>	1.0 12.2 11.7	TINK <sub>2</sub> .2NH <sub>3</sub> + 9.7KNH <sub>2</sub> - 0.5NH <sub>3</sub> TINH <sub>2</sub> + 11.7KNH <sub>2</sub> - 0.5NH <sub>3</sub>	



quantities of ammonia of crystallization with an apparent tendency, however, toward a fixed ratio between this ammonia and the thallium amide.

It will be clear from the account given of these experiments together with the summary of results embraced in the table that the products obtained must be isomorphous mixtures. Each specimen prepared and submitted to analysis was well crystallized and entirely homogeneous in appearance so that it is impossible to assume that the large and varying amounts of potassium amide present in the specimens are accounted for on the assumption of mere mechanical admixture. In the direction of increasing thallium content of these isomorphous products the limit seems to be the compound of the formula given above; in the other direction there is probably no limit short of pure potassium amide itself.

It has been observed that the compound of the formula  $TlNK_2 \cdot 4NH_3$  is much less soluble in liquid ammonia than is potassium amide, and that the mixed crystals show a greater solubility the higher their potassium content. It therefore follows that the ratio of thallium to potassium in the mixed crystals separating from a solution containing the two compounds must always be higher than in the solution. In accordance with this rule, it has been found possible to obtain a pure specimen<sup>1</sup> of potassium ammonothallite from a solution containing a large excess of potassium amide by four carefully conducted recrystallizations of the yellow salt. Another preparation<sup>2</sup> separated from a solution containing five equivalents of potassium amide to each equivalent of thallium, and recrystallized twice gave a specimen of potassium ammonothallate with an admixture of but 0.14 molecule of potassium amide. A third preparation<sup>3</sup> separated from a similar solution and recrystallized but once gave a specimen containing 0.6 of a molecule of potassium amide. In further agreement with the above mentioned rule, it has been found that the

<sup>1</sup> Preparation V, p. 695.

<sup>2</sup> IIa, p. 688.

<sup>3</sup> IIIa, p. 696.

crops of crystals IVa, IVb and IVc, experiment 4, obtained in the manner described without recrystallization are successively poorer in thallium while at the same time the ratio of potassium to thallium in the mother liquors steadily rises. The analysis of the residue from the evaporation of the final mother liquor is given in the table to show the large increase in this ratio.

It does not seem possible to come to any positive conclusion as to what the chemical compounds are which enter as constituents into these isomorphous mixtures. The formulas given in column IV of the table are calculated from the composition of the residue left after removing a portion of the ammonia with which the mixed crystals separated from solution and do not, therefore, necessarily represent isomorphous mixtures. They are rather the formulas representing mechanical mixtures resulting from the deammonation of true mixed crystals.

The formulas given in column V represent the respective specimens as isomorphous mixtures either of the compound of the formula  $TlNK_{7.4}NH_3$  and potassium amide or of thallium amide and potassium amide with an amount of ammonia in the latter case roughly proportional to the amount of thallium present. The first method of formulation has this in its favor that the assumed constituents of the mixed crystals are known compounds. The principal objection to such formulation is that the two rather widely differently constituted compounds represented by the formulas  $TlNK_{7.4}NH_3$  and  $KNH_2$  are thereby assumed to be isomorphous, that is, to possess high mutual solubility. In favor of the second method of formulation is the plausibility of the assumption that two similarly constituted compounds, thallium amide and potassium amide, are isomorphous, and the plausibility of this assumption is enhanced when the fact is recalled that many of the known compounds of thallium and potassium form mixed crystals. The principal difficulties in the way of accepting this interpretation of these mixed crystals are, first, the fact that thallium amide does not exist, and, second, the

difficulty of interpreting the presence of ammonia in quantity always proportional to the amount of thallium in the mixture. It is even possible to look upon these products as solid solutions of thallium amide, potassium amide and ammonia and it may be that the distinctly unsatisfactory results attendant upon the efforts to determine the amount of ammonia retained by the crystals at low temperatures are due to the isomorphism of ammonia with its derivatives thallium amide and potassium amide.

It has not been possible to determine the crystalline form of either potassium amide, of potassium ammonothallate or of the mixed crystals, nor is there any certainty concerning the amount of ammonia combined with any of these products as they separate from the solution, for even when dried at  $-40^{\circ}$  the brilliant appearance which potassium amide and the isomorphous mixtures show when in contact with their solutions are dulled to such an extent that it is difficult to say whether or not they may have lost a portion of the ammonia with which they separate from solution.

The writer is under especial obligations to Dr. Elias Elvove for the excellent manner in which the analyses recorded in this paper have been carried out.

#### Summary

The results obtained in the investigations recorded in this paper may be summarized as follows:

1. When a liquid ammonia solution of potassium amide is added to a thalious salt, likewise in solution in liquid ammonia, a black precipitate of thallium nitride is formed. Thallium nitrate, for example, has been found to react with potassium amide in accordance with the equation

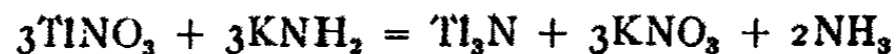

2. Thallium nitride dissolves readily in liquid ammonia solutions of potassium amide. When the ammono base is used in limited quantity a yellow solution is formed from which a compound of the formula  $\text{TlNK}_{2.4}\text{NH}_3$ , which has been named dipotassium ammonothallite, may be obtained

in the form of beautiful yellow crystals. The compound is formed in accordance with the equation



3. Crystallized potassium ammonothallite readily loses successive portions of its ammonia of crystallization to form products of the composition represented by the respective formulas  $\text{TINK}_{2.2}\text{NH}_3$  and  $\text{TINK}_{2.1\frac{1}{3}}\text{NH}_3$ . The composition of dipotassium ammonothallite and its deammonation products may also be represented by the formulas  $\text{TiNH}_{2.2}\text{KNH}_2$ ,  $2\text{NH}_3$ ,  $\text{TiNH}_{2.2}\text{KNH}_2$  and  $\text{Ti}_3\text{N}.6\text{KNH}_2$ , respectively.

4. When thallium nitride is dissolved in excess of potassium amide solutions are formed from which well crystallized products have been obtained, which are impossible of formulation as definite chemical compounds. These products are looked upon as isomorphous mixtures of the compound  $\text{TINK}_{2.4}\text{NH}_3$  with potassium amide or perhaps rather as isomorphous mixtures of the unknown thallos amide and potassium amide. A considerable number of specimens of mixed crystals has been prepared in which the atomic ratio between thallium and potassium varies from that of the definite compound of the formula  $\text{TINK}_{2.4}\text{NH}_3$  to that of the isomorphous mixture represented by the formula  $\text{TINK}_{2.4}\text{NH}_3.3.6\text{KNH}_2$ .

*Hygienic Laboratory,  
U. S. Public Health  
and Marine Hospital Service,  
Washington, May, 1912*

## NEW BOOKS

*Die physikalische Chemie der Proteine.* By T. Brailsford Robertson. Translated by F. A. Wyncken. 15 × 24 cm; pp. xi + 447. Dresden: Theodor Steinkopff, 1912.—In the preface the author says: "The investigations of recent years on the behavior of proteins and of colloids in general have resulted in building up two schools having markedly different views. Except where prevented by technical difficulties, one school tries to apply the well-known laws of what may be called molecular-physical chemistry direct to proteins and to other colloids, while the other school objects to doing this. So far as the proteins are concerned, it seems to me that the important point at issue between the two schools is whether we are or are not justified in assuming that Avogadro's law applies to solutions of proteins. In other words, are protein solutions molecular-disperse systems or are they suspensions or emulsions? The second of the two schools, as a result wholly or in part of *a priori* conclusions, believes that Avogadro's law cannot be applied to protein solutions, or at least that its validity should be shown before we attempt to apply it. The first of the two schools believes in assuming that Avogadro's law is applicable until direct proof to the contrary is shown." The author has therefore presented the subject of the proteins on the basis that we are dealing throughout with true solutions. It is a very clever piece of work and one must regret that so much ability has been wasted on a false thesis. The author might have written a book which would have been a standard for all time. In the opinion of the reviewer, the author has merely succeeded in showing how easy it is to prove that black is white. The reviewer owns up to having been carried off his feet once or twice.

The book is divided into four parts: chemical statics of proteins; electrochemistry of proteins; physical properties of proteins; chemical dynamics of proteins. In the first section the author discusses: the chemical characteristics of proteins; the preparation of pure proteins; and the compounds of the proteins. Under the electrochemistry of the proteins the subheads are: formation and dissociation of salts of the proteins; the basicity and acidity of the proteins; the electrical conductance of solutions of salts of the proteins; the electrochemistry of coagulation. Under physical properties of proteins the chapters are: the phenomena accompanying the changes of state of proteins; certain physical properties of protein solutions; optical properties of protein solutions. In the last section, under dynamics, the author considers: hydrolysis of the polypeptides; hydrolysis of the proteins; synthesis of proteins by means of enzymes.

Since protein solutions are good conductors and yet show neither chlorine nor calcium ions, as the case may be, pp. 24, 143, the author deduces the existence of organic ions. Litmus paper is not reddened by the water in which casein is suspended, pp. 33, 67, but is reddened by contact with the solid particles. This in itself is strong evidence that we are dealing with an adsorption; but the author calls it proof that casein is a base. It is rather interesting to note that casein is readily soluble in dilute hydrochloric acid, p. 75, only when freshly precipitated and still moist. The author distinguishes, p. 84, between coagulation and precipitation. He calls it precipitation when only a small amount of

the precipitating agent is required and coagulation when a large amount is necessary. There is no doubt but that there is a striking difference between the two cases, but it seems very probable to the reviewer that this is one of the differences which the prophet ignores instead of emphasizing. It also seems to the reviewer that the effect of anions, pp. 86, 99, and of time, p. 95, could be discussed better from the view-point of colloids than of true solutions. Since the author has no definite criterion as to what constitutes a compound, it is not surprising that he reaches the conclusion that dyeing, p. 126, involves the formation of definite compounds.

The author makes out the strongest case for his point of view in the section on the electrochemistry of proteins; but it is only fair to add that this may be due to our ignorance rather than to the soundness of the author's conclusions. For instance, a high potential difference between a metal electrode and a solution indicates a low concentration of metal as ion in the solution; but we may get this result either by postulating a complex salt or by postulating an adsorption. The reviewer is strongly of the opinion that all conclusions are of doubtful accuracy which are based on electrometric measurements with alkaline tartrate solutions, etc. Of course, the author could not be expected to know this; but the real future of the book depends on the soundness of the point of view.

In one case the author has slipped up. He says, p. 104, that it is impossible to have hydrated copper sulphate and casein coexisting as separate solid phases in equilibrium with solution and vapor. He postulates that the temperature and pressure are both constant. If we ignore the air, the pressure is variable. If we do not ignore the air, the pressure is constant but the number of components is increased. There is one case, p. 106, where the reviewer doubts the evidence on which the conclusions are based. Pickering found that either water or propyl alcohol would pass through a given diaphragm but that a mixture of the two would not. This is an argument in favor of the existence of solvates. This work has never been repeated by anybody, not even by Pickering. The alleged result is an extremely improbable one and the reviewer is quite certain that we have not all the facts in regard to the matter.

The reviewer would like to see the author display his versatility by rewriting the book from the other point of view. No one else could do it so well, just as no one else could have written the present book so well. Granted the point of view and this book is a masterly presentation. The subject has been treated so well and so consistently that the burden of proof is on the man who says that the point of view is wrong—in other words, on the reviewer. He expects some day to make his position good.

*Wilder D. Bancroft*

*The Elements of Qualitative Chemical Analysis. By Julius Stieglitz. Vol. I, Theoretical Part. 14 X 22 cm; pp. x + 308. New York: The Century Company, 1911. Price, \$1.40 net.*—In the preface the author says:

"In the experience of the author, although the majority of students attending his lectures had already acquired some knowledge of chemical and physical equilibrium, of the theories of solutions and of ionization and of their applications, the more exhaustive treatment of parts of these subjects and of related topics, to which a course in qualitative analysis lends itself, has been of particular benefit to them, bringing them into closer touch with the method of detailed

study of a chemical topic, than the broader, more varied work of general chemistry courses usually does. Throughout the theoretical treatment of the subject, the attempt is made to prepare the student for a more general *quantitative* expression of chemical relations. For this reason, chemical and physical equilibrium constants are given and used, whenever it is possible. The author is aware that the 'constants' have, in part, only a temporary standing; that more exact work will continually modify their numerical values and, probably, limit the field for their *rigorous* application. The latter facts can be impressed upon the student and still the invaluable principle be inculcated in his mind, that chemistry is striving to express its relations, as far as possible, in mathematical terms, exactly as its sister science, physics, has long been doing. At the same time the treatment of physicochemical topics has been kept within the bounds set by the subject matter, and by the chemical maturity of the students addressed; it is elementary in form, and quantitative relations are used, in the main, only to elucidate qualitative facts. The rigorous development of the subjects presented and their elaboration from a purely physicochemical standpoint are left to advanced courses. It has been found that this method interests the better class of students in seeking such advanced courses."

This volume contains the first and second parts of the book: the fundamental principles and their application. "A rather thorough and somewhat critical study is first made (in Part I) of the fundamental general chemical principles which are most widely involved in analytical work. The applications of these principles to the subject matter of elementary qualitative analysis are then discussed (in Part II)." In Part I the author discusses: osmotic pressure and the theory of solution; ionization and electrical conductivity; ionization and osmotic pressure; ionization and chemical activity; chemical equilibrium and the law of mass action; physical or heterogeneous equilibrium including the colloidal condition; simultaneous chemical and physical equilibrium, or the solubility product. In Part II we find such headings as: systematic analysis of the common metal ions; the ions of the alkalis and of the alkaline earths; order of precipitation of difficultly soluble salts with a common ion; aluminum; amphoteric hydroxides; hydrolysis of salts; the aluminum and zinc groups; the copper and silver groups; precipitation with hydrogen sulphide; the theory of complex ions; the arsenic group; sulpho-acids and sulpho-salts; oxidation and reduction reactions; oxidation by oxygen, permanganates, etc.; systematic analysis for acid ions.

The first part of the book consists of a very good presentation of certain portions of physical chemistry. Of special importance to those interested in analysis are the sections on solubility of fine powders, p. 123; on adsorption by colloids; on the solubility product, p. 142; on washing precipitates, p. 148; on hydrolysis, p. 176; on the precipitation of zinc sulphide, p. 204; on complex ions, p. 220. There is an interesting paragraph on reactions in non-aqueous solutions, p. 84, and the author recognizes that the apparent molecular weight varies with the heat of dilution, p. 12. The only slip which the reviewer has noticed is on p. 120, where the author has followed Nernst in taking the distribution of bromine between chloroform and water as a typical instance of distribution. He refers to the solubility of bromine in chloroform but does not define what he means by a saturated solution.



The most interesting thing about the book is its general plan. Should the student have as much physical chemistry as this so early in his course? At most places it would be quite impossible, but at the University of Chicago there is more physical chemistry included in the first course than at any other place about which the reviewer knows. The author's book would not be possible except for this. Granting, however, that the freshman has had Smith's Chemistry, should he take Stieglitz's Qualitative Analysis? This is a very interesting question, but it cannot be answered now. The only test is whether it works well and, as to that, the reviewer has no knowledge. He is glad, however, to have this opportunity to call the attention of his colleagues to this book. Either Mr. Stieglitz is a pioneer in the teaching of qualitative analysis or he is an enthusiast who has overshot the mark. Whatever the conclusion may be in regard to this, there is no doubt but that Mr. Stieglitz has made an admirable presentation of the subject from his point of view.

Wilder D. Bancroft

J. H. van't Hoff's *Amsterdamer Periode 1877-1895*. By W. P. Jorissen and L. Th. Reicher. 16 × 25 cm; 106 pp. Helder: C. de Boer, Jr, 1912.—This volume contains a sketch of van't Hoff's work during the eighteen years that he was at Amsterdam. Reicher was van't Hoff's assistant for ten years, 1883-1893. His work with van't Hoff included the determination of the inversion point of sulphur and the study of the saponification of the esters by bases. Jorissen took up the study of active oxygen after Ewan left Amsterdam.

The book opens with an account of the teaching of chemistry in Amsterdam from 1784 onward. Next we have van't Hoff's work in the old laboratory and in the new one, followed by an outline of the circumstances under which van't Hoff went to Berlin. The authors have included van't Hoff's memorial address upon Gunning and also sketches of van Deventer and of Reicher written by van't Hoff for doctor-jubilees of these two former assistants. The usual bibliographies are given.

This sketch will be welcome to all who knew van't Hoff and those who had not that privilege will learn much from a perusal of the pages. W. D. B.

*Notes on Qualitative Analysis*. By Horace G. Byers and Henry G. Knight. 15 × 22 cm; pp. 177. New York: D. Van Nostrand Company, 1912. Price: \$1.50.—In the preface, the authors say:

"Most of the small texts are designed, or at least serve, merely as a guide to the laboratory practice of the art of analysis. Many ignore wholly any relation between the laboratory work and the principles of general chemistry. The larger works are of two types: those which are extremely detailed laboratory guides and those which couple the theories and laws of chemistry with directions for analytical procedure to an extent which makes them too involved for use in the ordinary laboratory course, where a limited amount of time can be devoted to the subject. In addition there are always special conditions which confront the teachers in their various environments which render a particular arrangement desirable.

"In our courses we present qualitative analysis as a part of the work in general chemistry, and it therefore serves as the experimental illustration of the chemistry of the metals. We also offer an advanced course which serves



to develop the art of analysis and also deals in a broader way with the rationale of the operations. We have, therefore, prepared these notes, which represent the kind of course we desire to give our own students, and offer them for publication chiefly for home consumption. If others have our viewpoint, they may find them useful.

"We have tried to keep in mind that qualitative analysis should develop laboratory technique and enable the student successfully to carry out the identification of inorganic materials. It should also widen the knowledge and appreciation of the student of the fundamental principles of chemistry and enable him to make use of the general theories as applied to particular and individual questions. It should not be complete within itself, but should stimulate to wide reading and the correlation of the occurrence, preparation, and uses of the elements and their compounds with the reactions used for their separation and identification."

The general tenor of the book can be seen from the following subheads under the general caption of chemical principles involved in qualitative analysis: definition of solution; kinds of solution; phenomena of solution; hydrates in solution; hydration of ions; osmotic pressure; van't Hoff's hypothesis; freezing point of solutions; boiling point of solutions; acids, bases, and salts in solution; electrolysis; hypothesis of Arrhenius; physical equilibrium; chemical equilibrium; ionic equilibrium; solubility product.

The reviewer questions the desirability of referring to hydrated ions, p. 9, before the student has had the electrolytic dissociation theory, p. 29. The reviewer also does not like the definition, p. 7, that "a solution is a homogeneous mixture of two or more substances." This does not state the essential criterion that the composition can vary continuously within certain limits. In the minds of the authors this is undoubtedly connoted by the word "mixture;" but that is not quite fair to the student.

*Wilder D. Bancroft*

*Die Entdeckung des Radiums.* By Mme. P. Curie. 15 X 22 cm; pp. 28. Leipzig: Akademische Verlagsgesellschaft, 1912. Price: 1.50 marks.—This is an address delivered by Mme. P. Curie in Stockholm on Dec. 11, 1911. In it Mme. Curie recapitulates the work on radium. The belief that radium is an element is based on the fact that it has a definite spectrum. This definition is a very popular one nowadays; but it is a comparatively recent one. Twenty-five years ago the definition of an element was that it could not be resolved into other substances. Elements could react synthetically, but in no other way. Of course we are at liberty to change our definitions to suit ourselves; but the new criterion cannot be applied satisfactorily. So far as the reviewer can see, the only advantage of it is to enable us to say that chemists have decomposed an element. Mme. Curie is quite positive in her view, p. 22, that radium is not a compound of helium with any other substance and yet the only way in which she can make radium an element is by changing the old definition of an element so that it shall not include radium.

The scientific value of the work of the Curies, of Rutherford, and of the others in this field, remains the same no matter how we define an element. Why not leave the melodramatic side to the people who specialize in that sort of thing?

*Wilder D. Bancroft*

## SUNLIGHT<sup>1</sup>

BY PAUL C. FREER<sup>2</sup> AND H. D. GIBBS

Five years ago, the study of the effect of tropical sunlight was commenced in this laboratory by the investigation of certain chemical reactions which are catalyzed by light. The causes of the coloration of phenol and aniline were first studied and the reaction products isolated. Since prior attempts in this direction in other parts of the world had proved to be a failure, we naturally surmised that the reactions were more rapid in the Tropics, producing products in sufficient quantities to facilitate their identification, a conclusion which, at this time, we do not feel was entirely justified. By means of a chemical photometer, comparisons of light intensities in various localities, in and out of the Tropics, showed that on clear days the rates of reaction were practically uniform in all of the places investigated. The work was then extended to the study of the effects of the sun's rays upon experimental animals and upon human beings. A statement of the results obtained in all of these phases of the work is given in this paper.

The influence of sunlight in the Tropics has been the subject of extended discussion for many years, and the intensity of insolation has generally been considered to be the dominating factor. In considering the question of what may be regarded as a tropical climate, we are too apt to be influenced by preconceived opinions, and to lose sight of the fact that there is as much difference between tropical climates as between those in the temperature zone. It can readily be

---

<sup>1</sup> A paper read before the Eighth International Congress of Applied Chemistry in New York, September, 1912.

<sup>2</sup> Paul C. Freer, M.D., Ph.D., Director of the Bureau of Science, Manila, P. I., died on April 17, 1912. This article is written by H. D. Gibbs, chief of the Division of Organic Chemistry, Bureau of Science, and associate professor of Chemistry, University of the Philippines, Manila, P. I. It was our intention to contribute several articles to the Eighth International Congress of Applied Chemistry, on the sunlight work carried on in the Philippine Islands. The entire work is summarized as briefly as possible in this one paper.

understood that a place recognized to be within the Tropics may, by reason of its proximity to the sea, its altitude, its relation to mountain chains and other natural surroundings, have a climate so modified that the actual sunlight may have less influence than in localities which are situated upon the borders of, or even well within, the temperate zones.

The races native to the Tropics, where the absence of a pronounced winter is favorable to the rich development of microscopical life, have no knowledge of bacteriology and pathology which would enable them to understand protective measures to avoid infectious and other diseases, and as a rule they do not have access to the complete food supplies of persons in temperate zones. As a consequence, many of the ill effects which are attributed to sunlight may, in reality, be due to entirely different causes. The subject under discussion is so complex, and is influenced by so many factors that, at the present time, general conclusions, excepting in so far as they are borne out by experimental evidence, are premature.

#### **A Study of Certain Chemical Reactions Catalyzed by Sunlight**

It long has been known that some benzene derivatives, such as most phenols and amino compounds, undergo changes in the light with the formation of colored compounds. In the case of phenols, one of us has shown that the formation of the colored compounds is due to oxidation which, in every case examined, results in the production of quinones. While decompositions and condensations set in, the first and most important colored compound formed is a quinone. In the sunlight, the reactions involved depend only upon the presence of oxygen, and the mechanism of the reactions can be explained by the presence of the labile hydrogen atom. The activity of the various phenols can be predicted by the presence of enol-keto tautomers, which Baly<sup>1</sup> and his co-workers

<sup>1</sup> Baly and Collie: *Jour. Chem. Soc.*, 87, 1339 (1905); Baly and Eubank: *Ibid.*, 1348; Baly and Desch: *Astrophys Jour.*, 23, 118 (1906); Baly and Marsden: *Jour. Chem. Soc.*, 93, 2108 (1908).

have shown can be determined from the study of the absorption spectra of the compounds in solution. This tautomeric condition is recognized through the formation of an absorption band which lies in the ultraviolet region of the spectrum. When the enol-keto tautomers are in the pure state, this band disappears, and its presence is characteristic of the coexistence of the tautomers in dynamic equilibrium. The tautomeric process occurring in acetylacetone and analogous aliphatic compounds causes a band similar to that produced by aromatic compounds, and in the same region of the spectrum.

The fixation of the labile hydrogen atom, precluding the formation of enol-keto tautomers, and in some cases the fixation of the hydrogen atom para to the hydroxyl group cause changes in the behavior of the absorption band and chemically increases the stability of the molecule. Aniline and methyl aniline give absorption spectra which indicate the existence of the labile hydrogen atom.

In the presence of moisture and oxygen, the sunlight oxidation may be attributed to hydrogen peroxide, for this oxidizing agent is formed by the action of sunlight upon water and oxygen<sup>1</sup> and it has been found that in, the dark, hydrogen peroxide and other oxidizing agents will produce the same result as those obtained in the sunlight. In the consideration of a structure of the benzene ring, the behavior in the sunlight of this class of compounds, containing the so-called labile hydrogen atom, is very suggestive.

It is possible that the reactions hereafter described do sometimes proceed at a more rapid rate in Manila than in higher latitudes; even if this is true, no reliable evidence is thus introduced that the sunlight is more active in the Tropics, for the temperature of the solutions exposed to the sunlight often rises to approximately 50°, and all of these reactions have high temperature coefficients.

---

<sup>1</sup> Gibbs: "The Question of the Production of Hydrogen Peroxide by the Action of Sunlight on Water and Oxygen," *Phil. Jour. Sci. Sec. A.*, 7, No. 2 (1912).

*Phenol.*<sup>1</sup>—This compound colors very rapidly in the sunlight in presence of oxygen. The principal compound formed is quinone and the presence of the brilliant red condensation product, phenoquinone, is highly probable. The crystals do not color so long as moisture and liquid phenol are absent and, it seems, that the crystals are the enol form, while the liquid contains both enol and keto tautomers. Anisol undergoes no change in the sunlight.

*The Cresols.*—The three cresols all color in the sunlight, the meta most rapidly and the ortho and para compounds much more slowly. The methyl ether of para cresol remains colorless.

*The Hydroxybenzoic Acids and their Esters.*—The meta compounds color most rapidly, the ortho next, and the para not at all. The esters color more rapidly than the free acids. The presence of oxygen is necessary and the cause of the coloration is oxidation. The oxidation of the meta and ortho hydroxybenzoic acids should produce the same compound as that formed from gentisic acid, namely, the para quinone of benzoic acid. This compound has been studied, and, while it has not been isolated in sufficient quantities for purification and analysis, there is every indication that it does not, of necessity, break down, giving off carbon dioxide as has been stated.<sup>2</sup>

*Quinol Carboxylic Acid (Gentisic acid).*—The esters of this acid color more rapidly in the presence of oxygen and sunlight than any of the other compounds studied. The free acid is also rapidly affected. The oxidation of the ester is easily effected in the cold by hydrogen peroxide, very dilute solutions of potassium dichromate, and potassium persulphate acidified with dilute sulphuric acid and other oxidizing agents. Potassium persulphate with dilute sulphuric

<sup>1</sup> Gibbs: "The Compounds which Cause the Red Color in Phenol," *Phil. Jour. Sci. Sec. A.*, 3, 357 (1908) and the Oxidation of Phenol; "The Effect of some Forms of Light and of Active Oxygen upon Phenol and Anisol, *Ibid.*, 4, 133 (1909).

<sup>2</sup> Nef: *Ber. chem. Ges. Berlin*, 18, 3499 (1885).

acid seems to produce the best results, although it is very difficult, in all cases, to carry the reaction to completion without, at the same time, causing decomposition. No evidence of decomposition to para quinone has been detected in the cold. The oxime

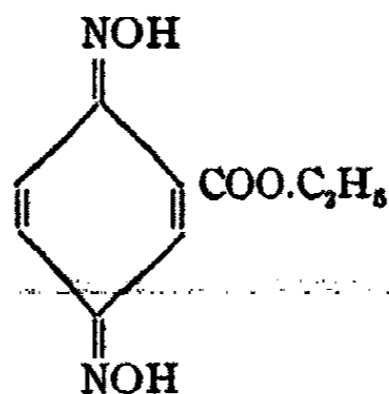

described by Jeanrenaud<sup>1</sup> has not been prepared but the monooxime  $C_6H_3 : O : NOH.COO.C_2H_5$  has been prepared by D. C. Pratt, by the oxidation of the ester with hydrogen peroxide in the presence of hydroxylamine-hydrochloride.<sup>2</sup>

*Aniline.*<sup>3</sup>—Pure aniline colors very rapidly in the sunlight. In presence of oxygen the colored compounds, azobenzene, 2,5-dianilinoquinone, dianilinoquinoneanil, and azophenine have been isolated. All of these are soluble in aniline, producing red solutions. In the absence of oxygen, *i. e.*, in the presence of indifferent gases such as hydrogen and nitrogen, or *in vacuo*, the coloration is also very rapid and the principal products are azophenine, benzene, and ammonia.

*Methylaniline and Dimethylaniline.*—Methyl aniline also colors rapidly in the sunlight and methylamine has been identified as one of the reaction products. Dimethylaniline colors much more slowly. Since no especial methods were employed to purify this compound, it is possible that the slight coloration observed after 60 days' exposure may be due to impurities.

<sup>1</sup> Ber. chem. Ges. Berlin, 22, 1783 (1889).

<sup>2</sup> Gibbs, Williams and Pratt: Phil. Jour. Sci. Sec. A., 7, No. 2 (1912).

<sup>3</sup> Gibbs: "The Compounds which Cause the Red Coloration of Aniline; I." "The Effect of Oxygen and Ozone and the Influence of Light in the Presence of Oxygen; II." "The Effect of Sunlight in the Absence of Oxygen," etc., *Ibid.*, 5, 9, 419 (1910).

*Methyl Alcohol.*—Ciamician and Silber<sup>1</sup> have found that ethyl alcohol and quinone react in the sunlight forming acetaldehyde and quinol. Methyl alcohol<sup>2</sup> and quinone produce formaldehyde and quinol. Methyl alcohol in presence of oxygen and sunlight or hydrogen peroxide in the dark is oxidized to formaldehyde.

#### Comparison of Sunlight Intensities

The actual number of hours of insolation per year on the earth's surface, where the sky is always clear, is greatest at the equator and diminishes toward the poles, the ratio between latitudes 0° and 45° being 1.83 to 1.34, although in the longer days in the temperate zone the sunshine reaching the earth when the sun is near sunrise or sunset is only a small proportion of that at midday. In the Tropics we have greater absorption and radiation by the earth's surface, factors which naturally vary with different regions according to the hours and intensity of insolation and the color of the surface exposed, being least with the green surfaces of vegetation.<sup>3</sup>

In the higher latitudes, the hours of insolation during the short days are so few and during the night the hours of radiation so many, that the surface of the earth steadily cools at certain times of the year, making one of the factors which causes a winter season.

Many instruments have been devised to measure the sunlight intensity and, while many are useful, all fall short of accomplishing the desired result. The involved regions of the spectrum are too extensive and are subject to too great relative variations to permit of grouping as a whole for purposes of comparison.

<sup>1</sup> Gazz. chim. Ital., 16, 11 (1886); Ber. chem. Ges. Berlin, 24, 1532 (1901).

<sup>2</sup> Gibbs: "The Action of Sunlight upon Methyl Alcohol," Phil. Jour. Sci. Sec. A., 7, No. 2 (1912).

<sup>3</sup> Hann: Handbuch der Klimatologie, 2, 23 (1910), calls attention to the measurements at Chinchochro, Laoango coast, near the equator. The regular measurements of the surface of the earth exposed to the sun gave temperatures over 75°, often 80°, and at one time nearly 85° C.

The Angström pyrheliometer which records the total normal insolation in heat units is probably the most successful device for a general comparison, but, in the ultraviolet, its sensitiveness is much inferior to other means of measurement which we have at hand.

The chemical photometers fail for the reason that they are only sensitive to their characteristic restricted regions of the spectrum, and their usefulness is limited to comparisons of these regions. For the ultraviolet and adjacent portions of the visible spectrum, the uranyl acetate-oxalic acid solution is the most satisfactory, although it is open to several objections which will be pointed out later.

### I. The Angström Pyrheliometer

This instrument is the best devised for comparisons of total insolation and is most sensitive to the longer wave lengths. Such data as are available have been gathered by Dr. Herbert H. Kimball of the Mount Wilson Observatory.<sup>1</sup> Comparisons are made of the annual maximum intensity of solar radiation at various points as follows:

Station and latitude		Intensity
Cape Horn	55° 31' S	1.47
Washington	38° 64' N	1.44
Montpelier	43° 36' N	1.60
Modena	44° 39' N	1.37
Kief	50° 24' N	1.39
Warsaw	52° 13' N	1.35
Hald	56° 25' N	1.32
Katherinenburg	56° 50' N	1.58
Pavlovsk	59° 41' N	1.48
Upsala	59° 51' N	1.35
St. Petersburg	59° 56' N	1.47
Treurenburg	79° 55' N	1.29

These variations are not great, and, such as appear, are attributed by Kimball to instrumental, rather than to atmos-

<sup>1</sup> Bull. U. S. Mt. Wilson Obs., 3, 100 (1910).



pheric conditions. Angström<sup>1</sup> records comparisons of Guimar (altitude 360 meters) and Alta Vista (altitude 3,352 meters) in Teneriffe (20° 30' north) as 1.38 for Guimar and 1.618 for Alta Vista, the latter high figure to be expected from the altitude.

The maximum observed by Dr. Rudolph Schneider at Vienna (48° 13' north)<sup>2</sup> was 1.524 in February, and figures ranging from 1.00 to 1.455 are quite frequent; indeed, the observations for the time near the noon hour in Vienna, although averaging somewhat lower, bear a remarkable resemblance to those in Washington when we consider that Kimball worked only on clear days and Schneider made observations on days of partial cloud and even of fog. Mr. Harvey N. Davis, working at Providence, Rhode Island, in ten months observed a maximum of 1.328 occurring in March, and, in general, his figures also bear a striking resemblance to those obtained in Vienna. Kimball, in discussing the annual march of radiation as compiled by him, stated that "a rather surprising uniformity throughout the year [is shown] in the maximum intensity of radiation, the December minimum being only 8 percent less than the April maximum." The departure by months from the average quinquennial mean shows that there is a considerable variation by years, amounting to a minus quantity of as much as 18 percent on the average for the year 1903. This diminution was widespread and such low times are periodic; the same is probably true of high periods, so that the absolute amount of insolation on the earth's surface may vary from year to year,<sup>3</sup> but the changes are not frequent enough or of great enough intensity to alter the picture as a whole.

Although the maximum radiation at the various points mentioned is very similar in all, yet, if we take the annual totals, we find differences for such points as have been compared.

<sup>1</sup> *Astrophys. Jour.*, 9, 342 (1899).

<sup>2</sup> *Jahrb. d. k. k. Zentralanstalt f. meteorol. W. Geodyn. N. F.*, 43, 12 (1906).

<sup>3</sup> Kimball: *Bull. U. S. Mt. Wilson Obs.*, 3, 114 (1910).

Kimball<sup>1</sup> has calculated the average monthly totals for Washington and Warsaw for normal surface, and from them we can obtain the yearly totals, which for Washington are 254,026 and for Warsaw 216,200, so that Warsaw actually has 85 percent of the radiation received at Washington, although it is 14° farther north. Unfortunately, pyrheliometer readings for places in the Tropics are not at hand. We ordered an Angström pyrheliometer nearly a year ago, but the instrument has not yet arrived. When it does, we will begin readings in Manila and thus obtain comparative data.

## II. The Chemical Photometer. The Uranyl Acetate-Oxalic Acid Solution

The most effective means yet discovered for comparing the intensities in the ultraviolet and adjacent regions of the visible spectrum are obtained from the rate of decomposition of the uranyl acetate-oxalic acid solution,<sup>2</sup> which has been utilized extensively in the laboratory of organic chemistry, Bureau of Science, first by Bacon,<sup>3</sup> whose preliminary paper on the subject has formed the basis for later work. The absorption spectrum of this solution is under investigation and this study will be published later. The other factors which influence the rate of reaction are the nature of the background, the size, shape, and material of the flasks in which the solution is exposed, and a small temperature coefficient.<sup>4</sup> While the reaction is complicated by more factors of importance than was originally believed and is by no means a perfect indicator, there is no doubt that, when the solution is properly employed, it affords a very useful means for comparison of light intensities of the region in which it is sensitive.

<sup>1</sup> Bull. U. S. Mt. Wilson Obs., 3, 103 (1910).

<sup>2</sup> The solution finally adopted in this laboratory consists of 5 cc of a 1 percent solution of uranyl acetate, 5 cc of a 10 percent oxalic acid solution (hydrated), and 20 cc of water.

<sup>3</sup> Phil. Jour. Sci. Sec. A., 2, 127 (1907); 5, 281 (1910).

<sup>4</sup> Bruner and Kozak: Zeit. Elektrochemie, 17, 354 (1911) state that the reaction has no temperature coefficient but with this we do not agree. The question is, at present, under investigation.

Having determined the basis of the investigation, colleagues in various parts of the world were asked to coöperate by a series of measurements with calibrated flasks and standard solutions exposed to the sunlight between the hours of 9 and 12 on a dull black surface, removed from side reflections. Returns from Manila (latitude  $14^{\circ} 36'$  north) (Table 1); Baguio (latitude  $16^{\circ} 25'$  north) (Table 2); Philippine Islands; Honolulu,<sup>1</sup> Hawaii Territory (latitude  $21^{\circ} 13'$  north) (Table 3); Kuala Lumpur,<sup>2</sup> Federated Malay States (latitude  $3^{\circ} 10'$  north) (Table 4); Khartoum,<sup>3</sup> Egypt (latitude  $15^{\circ} 36'$  north) (Table 5) in the Tropics; and Washington,<sup>4</sup> D. C. (latitude  $38^{\circ} 59'$  north) (Table 6); Tucson,<sup>5</sup> Arizona (latitude  $32^{\circ} 12'$  north) (Table 7); and Munich,<sup>6</sup> Germany (latitude  $48^{\circ} 8'$  north) (Table 8) are now available, and are given in the following eight tables.

The figures are all given in percent of oxalic acid decomposed in 1 hour and, so nearly as possible, reduced to uniform conditions.

In Manila (Table 1) the average percent of oxalic acid decomposed for 1 hour during one year was 12.45, with a maximum of 17.8 for the highest observed day, and a minimum of 1.15. The average of all days above the general mean was 14.56, and below, 9.64. Strange to relate, the lower average in Manila did not fall during the rainy months of July to October, but occurred in November, and the clear months of

---

<sup>1</sup> Through the kindness of the Hawaiian Agricultural Experiment Station, Dr. E. V. Wilcox, in charge, Mr. W. T. McGeorge making the titrations, using a 200 cc Erlenmeyer flask which has been sent to this laboratory for standardization.

<sup>2</sup> Through the kindness of the Institute of Medical Research, Dr. Henry M. Fraser, director, Mr. M. Barrowcliff making the titrations; a quartz flask was used.

<sup>3</sup> Through the kindness of the Wellcome Research Laboratories, Dr. Andrew Balfour, director, Dr. W. Beam, chemist.

<sup>4</sup> Through the kindness of Dr. Raymond F. Bacon, Bureau of Chemistry.

<sup>5</sup> Through the kindness of Dr. H. Spoehr, Desert Laboratory.

<sup>6</sup> Through the kindness of Professor Doctor Wilhelm Muthmann, Königliche Bayer. Technische Hochschule.

TABLE I—MANILA

Months	Average	Maximum	Minimum	Mean Maximum	Mean Minimum	Average temperature	Observatory thermometer readings	Black bulb readings	Clear days
1910									
May	13.21	17.7	3.21	15.42	6.88	32.09	37.2	46.9	10 out of 27
June	12.62	17.1	6.08	15.87	10.05	32.85	38.0	47.6	8 out of 25
July	13.74	17.8	4.61	15.95	10.07	33.37	36.6	47.6	7 out of 24
August	13.11	17.5	5.11	15.14	10.07	31.27	39.3	49.3	3 out of 25
September	10.94	17.1	1.15	13.51	6.05	30.30	35.2	47.2	4 out of 26
October	11.78	17.45	1.71	13.88	9.33	30.61	35.5	45.9	4 out of 26
November	9.97	17.38	1.47	13.78	6.16	28.57	33.8	44.5	1 out of 24
December	10.03	14.61	1.19	12.44	7.12	29.18	33.1	43.9	3 out of 22
1911									
January	12.69	17.64	7.99	14.91	11.20	30.51	35.1	45.3	5 out of 19
February	11.54	16.32	4.98	14.01	7.87	30.14	34.0	42.0	5 out of 22
March	13.13	17.35	4.64	15.24	10.45	—	36.6	46.0	11 out of 25
April	13.88	17.60	10.49	15.94	12.41	—	37.4	48.0	6 out of 17
May	13.27	15.09	10.28	15.48	13.06	—	39.1	50.3	11 out of 22
June	14.07	16.38	12.80	15.00	13.42	—	37.9	49.5	6 out of 17
July	11.83	14.06	7.11	13.18	10.22	—	35.7	45.1	0 out of 11
Average	12.45	16.82	5.52	14.65	9.64	30.889	36.3	46.6	

TABLE 2—BAGUIO

Months	Average	Maximum	Minimum	Mean maximum	Mean minimum	Observatory thermometer readings	Black bulb readings	Clear days
1911								
March	12.5	18.7	6.9	16.2	8.2	—	—	5 out of 13
April	16.1	20.6	8.3	17.9	12.1	27.3	51.2	3 out of 19
May	16.2	19.4	11.1	17.7	14.0	27.5	51.4	
June	11.9	16.7	7.1	—	—	—	—	
Average	14.2	18.8	8.3	17.1	11.4	—	—	

Sunlight

721

TABLE 3—HONOLULU

Months	Average	Maximum	Minimum	Mean maximum	Mean minimum	Average temperature	Clear days
1911							
January	11.78	17.40	3.77	14.67	7.47	21.1	0
February	13.49	16.71	6.29	15.57	10.72	21.1	7 out of 21
March	13.82	17.76	3.48	16.26	9.48	21.6	15 out of 25
April	14.30	17.99	5.46	16.04	10.83	22.8	13 out of 24
May	13.85	17.64	7.89	15.87	10.62	21.1	9 out of 26
June	13.64	17.41	6.62	15.46	11.34	21.1	15 out of 25
July	12.45	16.85	5.53	14.53	9.35	21.1	3 out of 25
August	14.58	18.51	9.08	16.28	11.92	21.6	10 out of 23
September	15.30	20.77	6.57	17.07	12.02	21.1	12 out of 20
October	14.96	18.37	8.24	16.46	12.47	21.1	14 out of 24
November	15.0	18.62	6.23	16.48	12.63	23.5	11 out of 23
December	12.7	17.0	6.7	15.87	9.76	22.5	11 out of 23
1912							
January	14.45	16.13	13.56	13.86	13.86	22.5	4 out of 5
Average	13.9	17.8	8.9	15.8	10.9	21.7	

TABLE 4—KUALA LUMPUR

Months	Average	Maximum	Minimum	Mean maximum	Mean minimum	Clear days	Temperature
1911							
March	15.27	17.3	12.2	16.70	13.56	5 out of 11	31.57
April	15.21	17.5	10.4	16.76	12.79	10 out of 18	32.56
May	15.25	17.5	9.0	16.66	11.25	7 out of 23	32.42
June	15.45	17.3	12.2	16.7	13.97	5 out of 13	32.80
July	14.53	17.3	9.3	15.6	13.09	5 out of 26	32.72
August	15.39	18.1	11.6	16.2	13.62	6 out of 25	32.06
September	15.94	17.5	12.0	16.91	13.99	11 out of 21	31.76
Average	15.29	17.5	11.0	16.52	13.18		32.27

TABLE 5—KHARTOUM, EGYPT

Months	Average	Maximum	Minimum	Mean maximum	Mean minimum	Maximum temperature	Clear days
1911							
September	17.4	19.6	14.8	17.8	16.5	40.2	12 out of 22
October	17.8	20.8	16.1	18.7	17.3	38.9	22 out of 31
November	18.2	19.2	15.4	18.9	17.3	39.7	24 out of 30
Average	17.8	19.5	15.4	18.5	17.0	39.6	

Sunlight

723

TABLE 6—WASHINGTON, D. C.

Months	Average	Maximum	Minimum	Mean maximum	Mean minimum	Clear days
1910						
June	9.91	12.70	6.54	11.55	7.18	5 out of 8
July	11.19	15.60	1.70	12.80	7.19	10 out of 14
August	10.37	15.75	1.85	12.75	6.81	8 out of 10
September	11.38	19.14	3.83	13.49	8.37	10 out of 18
October	12.91	16.66	4.37	15.05	10.16	14 out of 16
November	11.29	17.33	3.54	14.38	8.82	4 out of 9
December	11.51	15.85	5.00	14.15	9.27	8 out of 11
1911						
January	12.97	16.42	9.52	14.77	11.53	8 out of 9
February	15.01	20.34	9.66	20.07	11.64	4 out of 5
March	11.96	12.63	11.2	12.63	11.29	3 out of 3
April	13.09	13.48	12.32	13.48	12.32	
Average	11.96	15.99	6.33	14.10	9.50	

U. S. DEPARTMENT OF COMMERCE, BUREAU OF METEOROLOGY, WASHINGTON, D. C.



TABLE 7—TUCSON, ARIZONA

Date	Average	Maximum	Minimum	Mean maximum	Mean minimum	Clear days	Average temperature
1910 October	11.5	13.4	7.7	—	—	4 out of 6	28.7
1911 December	14.44	18.47	6.07	16.21	11.15	15 out of 20	19.8

TABLE 8—MUNICH

Date	Average	Maximum	Minimum	Mean maximum	Mean minimum	Clear days	Average temperature
June	13.10	16.89	5.25	15.55	9.65	4 out of 12	18.5
July	14.72	17.49	6.76	16.16	11.68	14 out of 31	22.9
August	13.91	18.15	4.80	16.31	8.91	13 out of 31	22.3
September	10.29	17.05	0.81	13.97	5.47	8 out of 30	17.2
October	7.54	14.41	1.35	10.37	3.61	3 out of 31	10.0
November	3.42	9.71	0.56	6.48	1.55	0 out of 30	5.1
December	2.39	6.09	0.36	3.86	1.30	0 out of 21	1.3
January	1.74	3.75	0.64	3.13	0.81	0 out of 5	2.4
Average	8.39	12.94	2.56	10.73	5.37		11.8

January, February, and March did not show so high a figure as the comparatively cloudy ones of June and July.

Kuala Lumpur (Table 4) shows a slightly higher average, 15.29 as against 12.45, and a somewhat higher maximum (18.1 against 17.8) and a much higher minimum, namely, 9.0 as against 1.15 for Manila. On average clear days in Kuala Lumpur the insolation in regard to the rays under discussion is practically the same as in Manila, but the cloudy and hazy weather of our island climate shuts off a proportion of the sunlight. The total effect is that of a climate having less insolation, and the difference between two places, one practically on the equator and the other  $14^{\circ}$  north, is a meteorological one, and not due to any excess *per se* of the shorter wave lengths in the former locality.

Honolulu (Table 3) shows an average of 13.9 or 1.45 higher than Manila and only 1.39 lower than Kuala Lumpur. It had an abnormal maximum in September, 1911, of 20.77, or higher than either of these tropical places, and a minimum of 3.48. However, the average of days above the average mean is 15.8 as against 16.52 for Kuala Lumpur. No months in Honolulu are so low as the lowest in Manila (September, December; 10.94 and 10.03, respectively). Therefore, Honolulu ( $21^{\circ} 18'$  north) has, as regards the photocatalytic action of the sun's rays, a condition much like that of Manila ( $14^{\circ} 36'$  north) and Kuala Lumpur ( $3^{\circ} 10'$  north), and the extraordinarily high days observed at that place indicate that, at times, the atmosphere on Hawaii is so free from disturbances, strata of varying density, or haze, as to allow even a greater proportion of the rays having photocatalytic action to reach the surface of the earth than is the case in the localities nearer the equator. No one will venture to state that the sunlight is more oppressive in Honolulu than in the Philippines; indeed, the general temperature is lower, the average temperature at the time of the observation was  $21.1^{\circ}$  to  $22.6^{\circ}$ , where ours in Manila was  $30^{\circ}$  to  $25^{\circ}$ . The difference among these three places under discussion is so

slight that we can say that practically the photocatalytic action in all is the same.

Unfortunately, only a few data have reached us from Tucson, Arizona ( $32^{\circ} 12'$  north) (Table 7), and these for the months of October, 1910, and December, 1911. They show a maximum of 18.47 or 0.67 higher than that of Manila and a minimum on one day of 6.07. The temperature during the observation averaged about as it does here ( $28.7^{\circ}$ ), and higher than at Honolulu. Doubtless, when a longer series of observations from this interesting point is at hand, we shall discover many days in Tucson where the maximum is as high as, or higher than, in Manila, and an average about the same.

The data from Washington need a little more careful analysis, as the methods followed were not always identical with the ones adopted by us as a standard, and the hours of insolation were not always the same. The results, recalculated to conform so nearly as possible to our conditions, are recorded in Table 6. So far as they are comparable, the results show that Washington, which has a winter season, presumably more atmospheric disturbances, many cloudy days, and possibly but few absolutely clear days, can show at times as much effect as the four places discussed and an astonishingly high average of 11.96. One day in September gave the hourly decomposition, between 8.45 and 12.15 in the morning, of 19.14 percent. Making allowance for the greater concentration of uranyl acetate used by Bacon, the totals in Washington are lower by about 33 percent than in Manila, excepting the one month, November, in Manila with an average of 9.97.

The results in Khartoum, Sudan (Table 5), are extremely interesting and, perhaps, the most instructive of the series. Khartoum is close to the desert and in about the same latitude as Manila. We find here, in observations extending through the months of September, October, and November, an average of 17.8 as measured by a standard quartz flask, or as much as 5.35 higher than Manila and 2.5 higher than

Kuala Lumpur, but this average is so high because of the remarkably uniform character of the insolation, the minimum being 14.8 as against 9.0 for Kuala Lumpur and 1.15 for Manila. The maximum observed day at Khartoum was 20.8, which is higher than any observation at Manila by 3.0 and 2.7 more than the highest observed at Kuala Lumpur, only two other observed days approaching this, one of 20.8 at Honolulu and the other 20.6 at Baguio in the Philippines, at an altitude of 1,445 meters. In Khartoum out of sixty-six days of observation, no less than fifty-two gave decompositions between 16.7 and 17.9, and eleven between 17.9 and 18.6. In Khartoum, therefore, we have a remarkably uniform, high insolation so far as the portion of the spectrum under consideration is concerned; but, nevertheless, the days of maximum illumination do not materially differ from those in the other localities, so that the absolute intensity of the ultraviolet illumination which may reach the earth on perfectly clear days is practically the same, the only distinctions being meteorological. If we consider this uniformly high rate and its causes, it is evident that the reverse can also be true and it would be possible to have so-called tropical climates where cloud interference and other causes would bring the average illumination below that in temperature zones. The temperatures of observations at Khartoum were somewhat higher than at Manila and Kuala Lumpur, but we observe that days of maximum temperature are not necessarily days of maximum photocatalytic decomposition.

The conditions at Munich (latitude  $48^{\circ} 8'$  north) are, in a measure, directly opposed to those at Khartoum. Here, during November and December, there were no clear days and the average decomposition for these months was 3.42 and 2.39 percent, respectively. On clear days, during the months of June, July, August, and September, the maximum decomposition very closely approached the maxima obtained in other places.

Another interesting comparison is furnished by Bruner

and Kozak<sup>1</sup> working in Krakau ( $53^{\circ} 40'$  north) on bright, sunshiny days in the spring and summer, the solutions in test tubes being exposed between the hours of 10 and 2. The background is not stated; but, as they worked before an open window, it is to be presumed that reflections did not play so important a part as with flasks placed on white paper, although the buildings had to be considered. Since the work was done in test tubes, we can not accurately compare results. Owing to the shape of the container, the variation might be considerable in amount, nevertheless, these authors, with a solution corresponding to our standard, obtained a decomposition of 15 as the maximum in their observations, so that it is apparent that, even in this latitude, days occur with a photocatalytic reactivity sufficiently high to be comparable with those in the Tropics.

In order to compare a climate at higher altitude and but little north of Manila with that of the latter city itself, a series of observations was made at Baguio (Table 2) (altitude 1,445 meters). The temperatures of the nights and in the shade of Baguio are so low that it is, in many respects, an ideal resort for recuperation from the lowland climate, yet the photocatalytic action is much the same, except that the maximum at Baguio is higher than in the lowlands (20.6 as against 17.8), being in this respect like Honolulu (20.7). The average is 14.2, or 1.75 more than in Manila and 1.09 less than Kuala Lumpur and 0.30 more than Honolulu. The black-bulb readings are practically the same. At Baguio, as is to be expected, we encounter a climate in which the rays undergoing observation are somewhat more intense than in the lowland. The average temperature in the sun during the observations was  $7^{\circ}$  to  $8^{\circ}$  lower than in Manila.

Manila and Baguio, at present, are the only places where the black-bulb thermometer readings are available simultaneously with the photocatalytic measurements, and a study of individual days demonstrates that the two figures, namely,

---

<sup>1</sup> Loc. cit., 35.

black-bulb readings and percentage of oxalic acid decomposed are not by any means functions of each other; indeed, within reasonable limits they seem to be independent. Of course, it is understood that a certain relationship exists, because, naturally on clear, bright days both black-bulb and photocatalytic readings will be high, and both the reverse on cloudy ones. As an example of these variations, we can cite a few figures taken from daily observations:

TABLE 9—COMPARISON BETWEEN PHOTOCATALYTIC AND BLACK-BULB READINGS IN MANILA

From 9 to 12 A.M.	Weather	Photocatalysis	Black-bulb (mean of three observations)
1910			° C
April 28	Clear	15.4	52.0
May 7	Clear	17.7	52.5
May 16	Slightly cloudy	13.4	54.0
May 18	Clear	16.4	52.0
June 9	Clear	14.7	54.5
July 5	Slightly cloudy	16.6	56.3

Comparisons of this kind can be extended almost indefinitely, but those given suffice to show that, in the same place and on apparently equally clear days, the relative proportions of the rays in the various portions of the sun's spectrum may vary considerably.

The supposedly injurious effect of tropical sunlight has been attributed, in a large measure, in the greater part of the literature, to the action of the more refrangible rays of the sun's spectrum, lying in the region of the violet and beyond in the ultraviolet, and to them have been attributed even grave morphologic changes sufficient to bring about permanent differences in races of the human family. So far as this work has gone it seems to develop that, if the so-called "actinic" rays in Manila are particularly objectionable, they are the same in Honolulu and, for a certain time of the year, even in Washington and other places. However, the more we consider the ultraviolet rays of the sun's spectrum, taking

cognizance of the fact that nowhere, whether in or out of the Tropics, do they extend<sup>1</sup> beyond 291  $\mu\mu$ , understanding what a large proportion, if not all, of the direct rays are subjected to molecular scattering, reflection, absorption, and dispersion by the upper layers of the atmosphere, and, noting the slight difference between the lowlands at Manila and highlands at Baguio, we are forced to the conclusion that, on clear days, when the sun is at the same angle, they are everywhere much alike in intensity. Indeed, it appears as if the greater part of these rays which reach the earth are diffused and not direct. In concluding this topic, we must observe that it may be possible that we receive rays the nature of which we have not yet determined and which, with our present physical technique, we are not likely to determine and which may have an influence in the phenomena of insolation. The discovery of such rays, if they exist, will form an interesting and important part of this subject.

#### **The Effect of Sunlight upon Animals**

The air temperatures at higher altitudes are lower than in the lowlands, although the effect of sunlight upon animals and solid objects, such as the black-bulb thermometer, may be greater in the former case than in the latter. This may be shown by a comparison of some available black-bulb thermometer readings. At Davos, Switzerland (altitude 1,559 meters), the average of the maximum black-bulb readings for three years was 53.8° with the highest absolute maximum of 67° in 1910; at Manila, the maximum for the year 1910-1911 was 56°; at Helwan, Egypt, the highest observed was 70.8° during a period of three years; at Alexandria, Egypt, the maximum was 57° during the same period. There are places on the edge of the desert, where the atmosphere is especially clear and where reflected light is present in great proportion, that exceed these figures; for example, Cairo in May and

---

<sup>1</sup> A large number of photographs of the sun's spectrum taken in Manila and Baguio show that the ultraviolet is cut off at about the same point that other observers have noted in various parts of the world, namely, about 291  $\mu\mu$ .

August, 1909, showed a maximum of  $79.5^{\circ}$ , and Aswan Reservoir in June, 1910, of  $81^{\circ}$ . In contradistinction to these, we have another remarkably high black-bulb reading at high altitude in Leh, Thibet (altitude 3,517 meters) of  $101.7^{\circ}$  with a shade temperature of  $23.9^{\circ}$ . Of course, these figures refer to the maxima only, and do not take into consideration averages or the shade temperature which may be high or low, but it is evident that the occurrence of days of extreme insolation is not so much a matter of latitude as situation, and that even in the Tropics we might come to averages decidedly lower than in some more northern temperate climates. It is obvious that in any one of the places mentioned a living body might encounter days in which it might be more heated by solar radiation than in the Tropics, and the only question would be whether the possibility of cooling, such as is brought about by lower atmospheric temperatures, low humidity, radiations, and other means, will compensate to avoid the effect of such insolation.

A body exposed to the sun absorbs a portion of the rays and reflects a portion of them, the most perfect absorber being a substance as nearly the ideal black as is possible. It loses the heat by radiation or convection (conduction), and while black bodies absorb radiations readily, they also radiate readily. It is a well-known fact that the ultraviolet rays are promptly fatal to all the lower organisms such as bacteria, amoebae, and protozoa; the heat effect on them being much less, and only apparent in so far as above certain temperatures they cannot live. As we ascend higher in the order of animals, devices for regulating the loss of heat begin to appear, until in birds and mammals, they are so well developed that but very little variation in blood temperatures is observable in the most diverse conditions of life.

Since the study of the heat effect upon such organisms appeared to be the most promising, this was first undertaken by Dr. Hans Aron<sup>1</sup> of the department of physiology of the

<sup>1</sup> *Phil. Jour. Sci. Sec. B.*, 6, 101 (1911).



University of the Philippines, in Manila, and later, by one of us in Baguio. The subcutaneous, rectal, and skin temperatures were accurately measured by means of thermocouples and a tangent galvanometer. Monkeys are naturally at home in the Tropics, and we should suppose that these animals would best be able to stand the effects of sunlight. Their system of sweat glands<sup>1</sup> is not so highly organized as in man, and their physical heat regulation is to a much greater extent brought about by water evaporated by the lungs and mouth through increased respiration. Aron found the normal subcutaneous temperature of the animal in the shade to vary from 36.6° to 38°; the rectal from 37.9° to 39.4°. The subcutaneous temperature therefore is somewhat below the rectal. However, so soon as the animal is placed in the sun, the subcutaneous temperature rises above the rectal and remains so to the end of the experiment. Animals exposed to the sun without protection, or artificial means of lowering the temperature, died in Manila in from one hour to one hour and fifty minutes, both skin and rectal temperatures steadily rising, the maximum before death being 43.5° and 42.7° to 46.3° and 44.8°. In Baguio, at a higher elevation, the animals died in even a shorter time, although the atmospheric temperatures were lower. Entirely different results are obtained if the animals are shaded even by a small area of shade such as an umbrella or a board, all other conditions being similar, except that the direct rays are excluded. Under these conditions the skin and rectal temperatures never exceed 40° and the animals remain healthy. Similar results

---

<sup>1</sup> Aron: *Ibid.*, 110, makes the statement that monkeys have no sweat glands. During the time at his disposal, as he was going on a long leave of absence, Aron did not investigate this question completely. Doctor Shaklee of the department of pharmacology, University of the Philippines, states that monkeys do have sweat glands. See also Blaschko: *Arch. f. mikros. Anat.*, 30 (1887); Wimpfelheimer: *Anat. Hefte*, 34, 492 (1907); Krause: *Beiträge z. Kenntniss der Haut. d. Affen. Inaug. Dissertat.*, Berlin (1888); is not available. Sweat glands have been found by Dr. Clark of the department of anatomy, University of the Philippines, in the forehead, hands, feet, axillae, and abdomina of our monkeys.

are obtained if the animals are exposed to the full insolation when care is taken to conduct away the excessive heat by means of a brisk current of air from a fan. Under these conditions the subcutaneous and rectal temperatures remain the same as in the animal shaded, and the monkey remains perfectly well. In this last form of experiment the monkey is exposed to all of the rays of the sun, including those of shorter wave length. If the effects are to be attributed to the absorption of the ultraviolet rays, then surely the animal is in the same condition to absorb the latter when no blast of air is present, and their effect should be apparent. On absorption a large portion of these rays is presumably converted to heat and conducted away as such, so that we can assume that the effects which are observed on exposing this animal to the sun, is one of the heat, and these conclusions are borne out at necropsies where post-mortem examinations give protocols clearly pointing to heat stroke. Monkeys enclosed in tight boxes with only the head exposed and placed in the full sun suffer no inconvenience, although the hair temperature on the scalp may reach  $47^{\circ}$ . The effects therefore are not due to penetration of the sun's rays to the brain. Of course, it must be understood that the monkey's skin is protected by fur, and is not sensitive to the irritating effects of the ultraviolet rays of the sun, as is the skin of a Caucasian, who, we know, if exposed to the sun, would be sunburned, whether in a strong blast of air or not. This latter effect is due to the ultraviolet portion of the spectrum, the rays of which are easily guarded against, and the skin can, in time, amply protect itself by pigmentation. Dr. Shaklee<sup>1</sup> has shown that monkeys, when exposed to the sun's rays for short periods daily, acquire a sort of immunity. After a few weeks' exposure they are able to remain in the sun for hours without ill effects. Experiments performed in Baguio<sup>2</sup>

<sup>1</sup> Results to be published in *Phil. Jour. Sci.*

<sup>2</sup> Gibbs, H. D.: "The Effect of Sunlight upon Men, Monkeys, and Rabbits, and a Discussion of the Proper Clothing for Protection," *Phil. Jour. Sci. Sec. B.*, 7, 91 (1912).

on rabbits gave remarkably conclusive and interesting results.

The rabbits exposed to the sun did not live so long as monkeys. White, grey, and black haired rabbits were employed in the experiments, and it was found that the black died first, the grey next, while the white rabbits were able to withstand the exposure. The subcutaneous temperatures taken with thermocouples through small slits in the lower dorsal region usually do not rise so high as those in the monkey's before death. These results are particularly interesting in relation to the question of proper clothing for the Tropics, in showing the protective value of the white coat as opposed to the darker colors.

F  
s  
r  
"  
y  
d

#### Experiments upon Human Beings

Experiments upon man are equally interesting. Here we have a subject with highly developed sweat glands, so that the means of heat regulation by evaporation are much more complete than in dogs, rabbits, or monkeys. Skin temperatures in this climate in the shade under normal conditions vary within the extreme limits of  $31^{\circ}$  to  $34^{\circ}$ , being higher over the muscular and fatty parts of the body than over bony structure lying close to the surface. Aron made a comparison of Malays and Americans and out of 14 observations, 12 showed a slightly lower skin temperature for the Malay, the highest of all observations being  $37.4^{\circ}$ . In our experiments in Baguio, all subjects exposed to the sun showed higher skin temperatures than those obtained by Aron in Manila, and all were above that of the blood, even though the air temperatures were considerably lower than in Manila. The lighter colored skins reached maxima in a shorter time than the darker, and the darker finally attained maxima higher than those of the lighter color. The theory of protective value of the darker skins would seem to be somewhat nullified by these observations.

Comparisons between an American and two dark-skinned Igorots, in the first series, and between a Canadian, a Tagalog, and an American negro in the second series, were made by

temperature measurements taken over the level of the third dorsal vertebra, the fifth dorsal vertebra, and over the upper angle of the scapula. The shade temperatures first taken showed the average of the lighter skins to be considerably lower than the dark, in some cases the differences being so great as  $3.68^{\circ}$ , namely,  $29.8^{\circ}$  for American and  $33.48^{\circ}$  for negro.

In spite of the fact that the American's temperature in the shade was, on the average,  $2.9^{\circ}$  lower than the Igorot's, on moving into the sun the three subjects (2 Igorots and 1 American) reached, on the average, about an equal temperature near the maximum, in thirteen minutes for the American, and about thirty minutes for the Igorots. The final temperatures are decidedly against the negro, slightly against the Malay, and in favor of the Canadian and the American.

The rapid rise of the white skin is explained by the irritation of the sensory nerve-endings, nerve-endings in the vessel walls, or of the vessel walls themselves, producing a flushing of the skin due to a greater quantity of blood and a more rapid flow. This effect, absent in the dark-colored skins even though they do absorb heat more rapidly, results unfavorably for the lighter colors. A greater quantity of blood flows to the exposed parts of the body and is there heated, and moreover it has been shown that ultraviolet light converts oxyhemoglobin into methemoglobin. Preliminary experiments, upon rabbits exposed to the sun, have shown that in some cases methemoglobin can be detected in the blood before death. This work is only begun and more definite statements at this time are premature.

While the series of observations upon human beings is not extensive enough to be conclusive in comparisons of the white and dark races, they at least show that the adaptable mechanism for heat regulation possessed by human beings is sufficient to lower the temperature and protect the individual from such fatal effects as are observable in monkeys. One fact very strikingly appears from these measurements, namely,

that the skin temperatures of all the subjects reach higher points in the sunlight at the high altitude of Baguio than they do in Manila, despite the lower shade temperature of the former place. It appears that the balance between absorption of heat on the side exposed to the sun and radiation from the shaded portion<sup>1</sup> of the body is against the dark skins and in favor of the lighter colors. On the other hand, with the white skin we have the phenomenon of sunburn and the resultant ill effects not obtained where there is the protection of pigmentation.

Chamberlain<sup>2</sup> has published the results of a series of observations in which he compared the relative resistance to the Philippine climate of blonde and brunette types of soldiers, and he concludes that the evidence is conflicting and that from a consideration of the facts the blonde is quite as well able as the brunette to withstand the climate.

Phalen<sup>3</sup> compared 500 troops in the Philippines dressed in orange-red underclothing with 500 dressed in white. The experiment showed that the red underclothing added materially to the burden of heat upon the system and that the white underclothing of practically the same weight was superior in this respect.

Since the body is cooled by radiation and evaporation of moisture, it is evident that any clothing which interferes with these processes will materially add to the burden of the individual. The ideal condition would doubtless be that attained by an umbrella where the subject is constantly in the shade and the radiation and evaporation of perspiration are unobstructed. It is remarkable how, instinctively or otherwise, the native in the Tropics has adopted this form of protection. In many places, the workers in the fields will be found to wear practically no clothing and a large hat manufactured of various native fibers often so large as one meter in

---

<sup>1</sup> It very rarely happens that the area of the shaded portion of an animal body, exposed to the sun, does not greatly exceed that of the surface exposed.

<sup>2</sup> *Phil. Jour. Sci. Sec. B.*, 6, 427 (1911).

<sup>3</sup> *Ibid.*, 5, 525 (1910).

diameter. The nearer the white person can approach this condition, the more comfortable he will be in the Tropics, when the effects of sunlight alone are considered. The clothing should be white and as thin as possible to allow for unobstructed passage of air currents.

Relative humidity plays a most important part upon the influence of the various factors which go to make up climate in the Tropics. The higher the relative humidity, other things being equal, the less rapidly will evaporation take place and less complete will be the lowering of the temperature. As the lowering of temperature is brought about by the evaporation of sweat, it necessarily follows that those races with the best developed sweat glands will have an advantage. Mr. Elbert Clark<sup>1</sup> of the department of anatomy of the University of the Philippines has made an extended investigation of this subject. After many measurements on American soldiers, Philippine scouts, and persons of both color in civil life, he has come to the conclusion that the Malay possesses from 12-15 percent more sweat glands than the white. Measurements on Negroes are not yet complete enough to warrant a final statement, but the results show that the race has perhaps an excess of 7 percent. The few counts which have been made upon Negritos show 26.82 percent excess for adults and 67.54 for youths. Nothing can as yet be said concerning the relative capacity of the individual glands of the two races. In this respect then the Malay possesses a decided advantage over the white man, which the latter can only offset by seeking greater shade. Probable, injurious, or disagreeable effects attributed to tropical sunlight are caused by the evenness of the climate rather than by the difference of insolation as compared with other places. The monotony due to the absence of severe contrasts, such as are given by winters, has its effect. However, Chamberlain<sup>2</sup> investigated the systolic blood pressure and pulse rate in

<sup>1</sup> Results to be published.

<sup>2</sup> Phil. Jour. Sci. Sec. B, 6, 431 (1911).

6,847 readings and 1,489 individuals of varying lengths of residence in the Tropics, and he found that the pressures were little, if any, below those found in temperate climates. There was no progressive tendency for the pressure to increase or decrease with continued tropical residence up to a little over three years, beyond which point his observations did not extend. He concludes that the mean blood pressure for Filipinos during the period of fifteen to forty years of age does not differ from the pressure at the same age for Americans residing in the Philippines, for neither race is very materially below the figure to be expected of white men residing in temperate climate. Other investigators believe that the blood pressures are lower in the Philippines and do not think that all of Chamberlain's conclusions are entirely warranted by his data. Musgrave<sup>1</sup> states "there is a general lowering of the blood pressure in tropical climates and that this affects all classes and conditions of people. The normal blood pressure of the Filipino runs lower than average figures taken from temperate climates and runs much lower than the pressure in the same people while residing in temperate climates."

In conclusion, it must be pointed out that if individuals must be exposed to the sun, as in the case of troops on the march, they can be given adequate protection from the sun by light, preferably white, clothing and helmets, but it must be remembered that perspiration is a great factor in keeping the body normal under these conditions and that during exercise in hot weather much water is lost during the day. Some of the ill effects attributed to the sun are probably due to rapid loss of water from the system and could be avoided if the individual were in a position to drink enough to preserve the equilibrium. If a supply of pure water is not present, the temptation to drink available water along the road may become irresistible, and sickness caused by infection from such a source may be attributed to the sun as a predisposing factor.

<sup>1</sup> Musgrave and Sison: *Phil. Jour. Sci. Sec. B.*, 5, 325 (1910). Further experiments now in progress, and results communicated by letter. These will be published shortly.



## THE THEORY OF EMULSIFICATION. IV

BY WILDER D. BANCROFT

Robertson<sup>1</sup> has published some results on emulsions of olive oil and water which are of especial interest because he succeeded in obtaining an emulsion of water in oil.

"If one shakes up, thoroughly, equal parts of slightly alkaline water and olive oil, a very stable emulsion is formed in which olive oil forms the internal phase and water the external; that is, the olive oil is suspended in the form of spherical droplets within the water. If we decrease the proportion of water, the resultant emulsion still continues to consist of droplets of oil suspended in water until the proportion of water to oil reaches a definite, critical value. When this critical ratio is reached, the character of the emulsion undergoes an abrupt change. From being a viscous, creamy-white emulsion of oil in water, it becomes a fluid, yellow emulsion of water in oil. The oil is now the external phase and the water the internal one. One can very readily detect which phase of the emulsion is external, without microscopical examination, by means of the following simple device: The bright red dye Soudan III is insoluble in water but readily soluble in oils; on sprinkling a few grains of Soudan III upon the surface of an emulsion of water in oil the color spreads rapidly over the surface. If, however, one sprinkles the Soudan III upon an emulsion of oil in water, the color remains confined to the droplets of oil with which the grains are in actual contact, since it cannot spread from them to adjacent drops through the intervening water.

"In many cases I observed an intermediate form. Suspended in the oil were drops which apparently consisted of an emulsion of oil in water; in other words the oil was external phase with an emulsion of oil in water as the internal phase. It is possible that a similar intermediate form exists in the

<sup>1</sup> Zeit. Kolloidchemie, 7, 7 (1910).



case of emulsions of oil in water, especially since it is difficult to tell by direct microscopical examination whether the drops suspended in oil are really drops of water or are a dilute emulsion of oil in water. In the tabulated data any emulsion with oil as the external phase is called an emulsion of water in oil unless it was recognized definitely as an emulsion in oil of drops of water containing oil.

"I think that the following nomenclature will prove serviceable because it shows what the constituents of the emulsion are, which phase is external, and which is internal. I use it throughout this paper and I recommend that an emulsion of oil in water be designated 'oil'-water and that an emulsion of water in oil be designated 'water'-oil. The intermediate case, to which I have referred, would be designated as 'oil-water'-oil.

"My experiments have been devoted chiefly to ascertaining the influence of the proportion of alkali to the total volume of emulsion upon the critical ratio of water to oil at which the emulsion changes character and ceases to be an 'oil'-water emulsion. It is a well-known fact that neutral, distilled water forms no stable emulsions with olive oil. The stability of emulsions of olive oil and water in presence of alkali is due to the action of the alkali on the fatty acids of the oil. Consequently one must conclude that the effect which alkali has on the stability of an emulsion of oil in water will depend on the amount of fatty acids in the oil. The olive oil used in these experiments was extremely pure; it was California oil and contained scarcely any free fatty acids, the absolute amount not being determined. The same oil was used in all the experiments.

"To prepare the emulsion, measured amounts of oil, distilled water and caustic soda were placed in an ordinary, narrow-necked, glass bottle holding about 150 cc. The flask was corked tightly, was placed in an upright position in a shaking machine, and was shaken vigorously for about 20 minutes. The machine made a thousand reversals per minute and displaced the flask horizontally and vertically

in a vertical plane so that the centre of gravity of the flask described a series of small ellipses in a vertical plane. During the shaking a good deal of air became mixed with the emulsion; but, in the less viscous emulsions, this rose very rapidly to the surface. When samples were taken 2 or 3 hours after the shaking had ceased, they contained very few air-bubbles.

"Two methods were used in studying the emulsion: the Soudan III method and the microscopical examination. In the following sets of observations, the experiments were so arranged that the caustic soda concentration remained constant while the concentration of the water increased by 1 percent in each succeeding experiment. The critical ratio of water to oil is the value at which the character of the emulsion changes. To obtain this I took the mean of the smallest ratio for which an 'oil'-water emulsion could be obtained and of the largest ratio for which a 'water'-oil emulsion could be maintained. If a mixture containing 8 cc water plus NaOH gave an 'oil'-water emulsion and if a mixture containing 7 cc water plus NaOH gave a 'water'-oil emulsion, the alkalinity being the same in the two cases, the critical ratio was taken as 7.5/92.5 because the total volume was always 100 cc. Of course the error in such a determination is 0.5/92.5.

"The data are given in Tables I-VI.

TABLE I  
In each emulsion 1 cc 5 N/1 NaOH

Oil cc	Water cc	Character of emulsion
99	—	'Water'-oil, fluid, yellow
98	1	'Water'-oil, fluid, yellow
96	3	'Water'-oil, fluid, yellow
92	7	'Water'-oil, fluid, yellow cream
91	8	'Water'-oil
90	9	'Oil'-water, creamy white, very viscous
89	10	'Oil'-water, creamy white, very viscous

Critical ratio =  $9.5/90.5 = 0.105 \pm 0.006$

TABLE II  
In each emulsion 1 cc  $N/1$  NaOH

Oil cc	Water cc	Character of emulsion
93	6	'Oil-water'-oil, fluid, yellow
92	7	'Oil'-water, creamy white, very viscous
91	8	'Oil'-water, creamy white, very viscous
89	10	'Oil'-water, creamy, fairly viscous
87	12	'Oil'-water, creamy, fairly viscous

Critical ratio =  $7.5/92.5 = 0.081 \pm 0.005$

TABLE III  
In each emulsion 1 cc  $N/2$  NaOH

Oil cc	Water cc	Character of emulsion
93	6	'Oil-water'-oil, fluid, yellow
92	7	'Oil'-water, creamy white, very viscous
91	8	'Oil'-water, creamy white, very viscous
89	10	'Oil'-water, creamy, distinctly fluid

Critical ratio =  $7.5/92.5 = 0.081 \pm 0.005$

TABLE IV  
In each emulsion 1 cc  $N/4$  NaOH

Oil cc	Water cc	Character of emulsion
91	8	'Oil-water'-oil, fluid, instable
89	10	'Oil-water'-oil, fluid with granulated structure, as though coagulated
87	12	'Oil-water'-oil, fluid with granular structure, as though coagulated
86	13	'Oil'-water, creamy white, very viscous
85	14	'Oil'-water, creamy white, viscous
84	15	'Oil'-water, creamy white, very fluid

Critical ratio =  $13.5/86.5 = 0.156 \pm 0.006$

TABLE V  
In each emulsion 1 cc *N*/6 NaOH

Oil cc	Water cc	Character of emulsion
87	12	'Water'-oil, fluid, yellow
86	13	'Oil'-water, creamy white, very viscous
85	14	'Oil'-water, creamy white, still distinctly viscous

Critical ratio =  $13.5/86.5 = 0.156 \pm 0.006$

TABLE VI  
In each emulsion 1 cc *N*/8 NaOH

Oil cc	Water cc	Character of emulsion
87	12	'Water'-oil, fluid, yellow
85	14	Not stable; two layers are formed, one 'water'-oil, the other 'oil'-water
83	16	Not stable; two layers are formed, one 'water'-oil, the other 'oil'-water
49	50	Not stable; two layers are formed, one 'water'-oil, the other 'oil'-water

No stable 'oil'-water emulsion could be obtained

"These experimental results indicate that above a certain alkali concentration (*N*/200 for this oil), the critical ratio of water to oil remains constant (at 0.08 for this oil); but that after the concentration of alkali falls below this limit the amount of oil which a given amount of water will hold in suspension diminishes progressively until, when the alkali-concentration falls below *N*/800 (for this oil), no stable emulsion of oil in water can be obtained. I am inclined to attribute these phenomena to the fact that the action of alkali in securing a stable emulsion of oil is due to the soap which it forms with the free fatty acid in the oil. So long as the alkali is in excess of the amount required to neutralize this acid, therefore, the concentration of soap in the system will be constant; when the concentration of alkali falls below this limit, the amount of soap in the system will be approximately

proportional to the amount of alkali and, as this diminishes progressively, the power of the water to surround the oil, as we have seen, grows less.

"On decreasing progressively the proportion of water to oil, one observes that the resulting emulsions are more and more viscous as one approaches the critical proportion until, just before that proportion is reached, the emulsion is so viscous as scarcely to flow at all. Immediately the critical ratio is passed, however, the emulsions of water in oil which are then formed are quite fluid.

"The permanence of an emulsion or of an extended surface of contact between two immiscible phases indicates, as I have pointed out, that the surface tension at the surface of separation is so small that the force tending to minimize the surface, that is, to coalesce the droplets of the internal phase is evanescent. Now Quincke<sup>1</sup> has pointed out that soap diminishes the surface tension at the surface of contact of oil and water, and Gibbs<sup>2</sup> and Thomson<sup>3</sup> have pointed out that substances which diminish the surface tension tend to become concentrated at the surface of which they diminish the tension. The reason for the permanence of oil and water emulsions in the presence of alkali is therefore clear; the soap formed by the interaction of the alkali and fatty acid becomes concentrated at the surface of the droplets and so reduces the surface tension that the force tending to restore a minimum surface of contact is exceedingly small. At the critical ratio, however, the soap is spread over so large an area that it is only just able to cover the surface of the oil droplets without leaving spaces of more than molecular dimensions.<sup>4</sup> Upon

<sup>1</sup> Sitzungsber, Akad. Wiss. Berlin, 1888, 791.

<sup>2</sup> Scientific Papers, 1, 235, 265 (1906).

<sup>3</sup> "Applications of Dynamics to Physics and Chemistry," 190 (1888).

<sup>4</sup> The fact that not all of the soap will be present in the superficial layer of the oil (or water) at the critical ratio does not, of course, invalidate the above reasoning. The proportion of soap contained in the surface of contact of the oil and water must be determined by the coefficient of distribution of the soap between the oil and the water and by the Gibbs equation  $\Gamma = \frac{c}{RT} \frac{d\sigma}{dc}$  (J. Wil-

passing this ratio the system breaks down to that possessing the next largest surface, namely, that in which the water is suspended in oil. The mechanical force exerted in emulsification, of course, secures, transitorily, the maximum possible surface of contact; should this surface, however, possess an appreciable surface tension as would be the case were the soap unable fully to cover the droplets, the system would break down to the arrangement securing the next largest area of contact, namely, in the case under consideration, that of droplets of water suspended in oil.

"The reason for the high viscosity of the oil-in-water emulsions, when the ratio of water to oil is very nearly that at which the character of the emulsions changes, is also clear. In these emulsions the soap is just able to cover the oil droplets without leaving spaces of more than molecular dimensions. Any strain leading to deformation of these droplets, such as would occur in flowing, would necessarily increase the surface of the droplets, since the sphere is the body which possesses the least surface for a given volume. Hence, in flowing, gaps would be produced in the soap-covering of the droplets; these gaps, however, would have a high surface tension; tending to bring together again the particles of soap, to restore the spherical form of the droplets, and thus to offer a resistance to the force deforming them, that is, to the flow. The resistance to flow at the critical ratio is therefore necessarily high, since any flow which occurs must result in local description of the system. It is possible that the absence of Brownian movements in droplets of protein separating out in the initial stages of gel-formation<sup>1</sup> is due to similar factors.

"I am inclined to believe that the mechanism leading to the formation of stable gels is of the same character as that lead to the formation of stable emulsions."

---

lard Gibbs: *Loc. cit.*); when this proportion is insufficient to cover the surface without leaving spaces of molecular dimensions, the system must break down.

<sup>1</sup> W. B. Hardy: *Jour. Phys. Chem.*, 4, 255 (1900).

This paper of Robertson's is valuable because he has actually prepared the two sets of emulsions. It is unsatisfactory because he worked with indeterminate solutions. He, himself, recognizes that the formation of the emulsion depends on the presence of salts of the fatty acids and yet we do not know how much sodium soap we have in any given case. There is no way of telling how much reaction has taken place in any given case between the olive oil and caustic soda. We do not even know definitely what sodium soaps are formed. Olive oil is sometimes given as containing 70 percent oleine, 25 percent palmitine and 5 percent linoline; but we do not know whether the oleine alone has been saponified or whether the other two constituents have also been decomposed to some extent. Consequently, we do not know whether the change in the character of the emulsion is or is not due to the sodium oleate. We also have the glycerol and the uncombined caustic soda as unknown and disturbing factors. It would have been more satisfactory if Robertson had added definite quantities of sodium oleate instead of free alkali. Assuming, however, that sodium oleate is the important factor in forming the surface films, the question arises why we should get the two sets of emulsions with olive oil while we do not with kerosene or benzene. I believe that the difference is due to the insolubility of sodium oleate in kerosene and benzene and to its solubility in olive oil. For high concentrations of oil, we may easily have the solubility of the oleate in the oil a more important factor than its solubility in water.

I cannot accept Robertson's conclusion that there necessarily is a critical ratio with one type of emulsion existing below it and the other above it. It seems to me quite conceivable that an emulsion might become instable at a given point without there being necessarily any formation of the other type of emulsion. That is certainly what seems to happen experimentally in most cases.

It is interesting to note that Robertson's shaker was apparently so efficient that he was able to mix the ingredients all at once and then to emulsify them. It would have been a

good thing if the observed limits had been checked by adding oil or water to an emulsion and then shaking again. It is always possible that this might have led to different results.

The preparation of emulsions is a regular practice in pharmaceutical chemistry; but the point of view differs radically from that held by the chemists who have been quoted hitherto. The pharmacist is quite clear in his mind that an emulsion consists essentially of capsules containing one liquid, suspended in another liquid. The problem that worries him is how best to get one liquid into capsules of a suitable size. The subject of emulsions is treated at length in Remington's *Practice of Pharmacy*,<sup>1</sup> from which I quote.

"Emulsions are aqueous liquid preparations in which oily or resinous liquids are suspended by the agency of gummy or viscid substances. They may be conveniently divided into two classes: 1. Natural emulsions. 2. Manufactured emulsions. They are opaque liquids, generally of a thick consistence.

"1. Natural emulsions are those which are found in nature, ready formed, as the milky juices of plants, the milk of animals, yolk of egg, etc.

"2. Manufactured emulsions are those which are made artificially by various processes. The art of producing them is termed emulsification

"Manufactured emulsions are usually made from two classes of substances: 1. Those which contain an oily or a resinous compound associated naturally with either gum or some other emulsifying agent. 2. Oils, fatty and resinous bodies containing no emulsifying substance.

"Gum resin emulsions and seed emulsions are included in the first class. These are usually made by simple triturating in contact with water.

"Gum resin emulsions are made by reducing to a coarse powder, in a mortar, selected pieces of the gum resin, triturating with a small quantity of water so as to form a smooth, uniform paste, and then adding the remainder of the water,

<sup>1</sup> Fifth edition, 1153 (1907).



finally straining the mixture through a cloth strainer or a plug of absorbent cotton contained in a funnel. Powdered gum resin should never be used for making emulsions, because of the loss or deterioration of the volatile constituents which always take place when the substance is dried so that it may be powdered.

“Seed emulsions are so termed because they are made by rubbing seeds or the kernels of fruits which contain fixed oils with water, the emulsifying agent being a gummy or albuminous substance found naturally in the seed or kernel associated with the oil. Emulsions of almond, castor oil bean, croton oil bean, etc., are examples of this kind.

“The theory of emulsification is based upon a study of the best type of a natural emulsion—namely, milk. This liquid is found, on examination, to consist of innumerable globules of a fatty substance (butter) enveloped in a thin membrane of viscid matter (casein) suspended in water. The object sought by the pharmacist in making emulsions is first to thoroughly divide the oily or resinous liquid into minute globules, and then to surround each globule with an adhesive envelope (mucilage of acacia, yolk of egg, etc.). The globules, when completely enveloped, are suspended in water, and if the emulsion is properly made, there will be no tendency on the part of the oily or resinous liquid to recombine. Several methods are employed in making emulsions, the most important of which, however, may be grouped under two typical methods, named from the geographical locations where they are used most frequently: 1. The English method. 2. The Continental method. Both are equally useful, and should be employed according to circumstances.

“1. *The English Method.*—In this mode of making emulsions the emulsifying agent, consisting of mucilage, yolk of egg, etc., is first placed in a dry mortar, and small quantities of oil and water are gradually and alternately added at intervals. The pestle is rapidly and lightly rotated (counter-clock wise), with the effect of dashing the oil into globules,

which are at once enveloped by the viscid emulsifying agent. If the oil or water is added too rapidly at the beginning, or the mucilage has not been thick enough, the accident of 'cracking' the emulsion occurs. This may be known by the 'pearly' appearance assumed by the mixture, and on close examination the globules of unenveloped oil may be seen floating about. If each stage of the process is successful, the emulsion presents, upon thorough mixing after each addition, a smooth, opaque, glistening appearance like cream. Success depends largely upon the care exercised in forming the nucleus at the beginning, and this, therefore, should not be too hastily made. When an emulsion is 'cracked,' it need not be thrown away. It may be restored by placing an additional quantity of mucilage in the mortar and gradually adding the 'cracked' emulsion to it, triturating after each addition, when finally the satisfaction of seeing the uncombined globules disappear will generally be experienced.

"The English method of making emulsions is the best to use in general prescription practice, where the proportions of gum, oily or resinous liquids, and water must necessarily vary. A typical formula is appended :

R Olei Morrhuæ f ounce ii  
Pulv. Acaciae ounce ss  
Aquæ q. s. ft. f ounce iv

"Place the acacia, which should not be finely powdered, but granulated, in a mortar with one fluidounce of water. This should be triturated until the mucilage is perfectly smooth and free from lumps. The oil should be added at first in quantities not greater than half a fluidrachm at a time, stirring rapidly with the pestle after each application, care being taken not to add a fresh portion of oil until the last one has been thoroughly emulsified. When the liquid becomes too thick to be easily stirred, a fluidrachm of water should be mixed with it, and the gradual addition of oil continued until the whole quantity has been used. The larger quantity of water may be added rapidly after the nucleus is once properly formed, without risk.

"2. *The Continental Method.*—This has the great merit of never failing to produce a good emulsion if the proper proportions are used to form the nucleus, and if the directions are strictly followed. The most satisfactory proportions may be easily remembered. Half as much water is taken as of oil, and half as much gum as of water; or it may be expressed as oil, 4; water, 2; gum, 1. The four parts of oil must be placed in a dry mortar and one part of finely powdered gum added to it, stirring with the pestle; when a uniform mixture is made, two parts of water are added, not gradually, but all at once, when, upon stirring, the emulsion is quickly made. An additional quantity of water may be added to this nucleus without risk. The explanation of making an emulsion by this method is, that the particles of gum, being insoluble in the oil and surrounded by it, are prevented from separating and dissolving in the water so as to form lumps; by stirring the mixture actively the water gradually dissolves the gum, the oil becomes incorporated at the same time, and a homogeneous mixture is produced, the quantities of oil, gum, and water being in exactly the right proportions to form an emulsion."

"*Casein Emulsions.*—The use of casein as an emulsifier has been developed by Léger, a Parisian pharmacist. He recommends the preparation of saccharated casein, a fine white powder, which is used for emulsifying just as is powdered acacia. The advantage claimed for casein are that its emulsions are more readily retained by the stomach, and that greater stability and perfection are secured through its use.

"Saccharated casein is prepared by heating one gallon of cow's milk to 104° F, adding two fluidounces of ammonia water, allowing the whole to stand a day, and separating the lower milky liquid from the oily liquid on top. The milky liquid (lactoserum) is treated with acetic acid until the casein is precipitated. After washing the precipitate thoroughly with water at 104° F it is collected on a muslin strainer, pressed, and dried; a weighed portion of the casein is dried and the percentage of moisture ascertained; the damp cake of

casein is then triturated with three and a half ounces of powdered sugar and eight parts of sodium bicarbonate for every one hundred parts of dry casein.

"Prolonged trituration and the addition of more powdered sugar, until it amounts to nine parts in one hundred, result in the formation of a paste, which must now be dried by a gentle heat not above 86° to 90° F. After complete drying, it is powdered and sifted. To make a casein emulsion of a fixed oil, fifteen parts of the oil are gradually incorporated with a mucilage previously made with fifteen parts of saccharated casein and five parts of water, when a perfect emulsion is formed and other ingredients are added.

"*Chondrus Emulsions*.—Since acacia is sometimes subject to fluctuations in price and is often expensive, various substitutes have appeared which have been tried as emulsifying agents, one of the most successful being the gelatinous substance obtained from chondrus or Irish moss.

"In the formulary, Part VI, under the heads of *gelatinum chondri*, *mucilago chondri*, and *emulsio olei morrhuae*, full information as to the methods of using it will be found. In this place it will only be necessary to say that a gummy substance in scales is produced by evaporating and desiccating a decoction of chondrus, and that a mucilage may be made from this Irish moss gelatin by heating eight grains of it in contact with one ounce of boiling water until it is completely dissolved. The mucilage, after being cooled, is then used for preparing emulsions exactly as mucilage of acacia.

"*Quillaja Emulsions*.—Quillaja, or quillaya bark contains the principle saponin, a glucoside which is capable of emulsifying oils. Senega contains an analogous principle. The property which both possess, of causing frothing in aqueous solutions, suggested the use of quillaja as an emulsifier. It has not come into extensive use, and care is necessary in employing it, as it is not without medicinal and irritating properties. One of the essentials of a good emulsifier is that it should be inert. Quillaja has been adopted in the National Formulary. (See *emulsio olei morrhuae*, Part VI, which

illustrates the method of using it.) Where an active medicine is to be made into an emulsion, and its properties are not antagonized by the quillaja, it may be judicious to employ it. Another disadvantage that it possesses is that a large quantity of tincture is required to be effective.

*Compound Emulsions.*—As a general rule, the addition of alcoholic liquids to emulsions destroys their homogeneity. When it is necessary to add them in compounding prescriptions, they should be diluted, if possible, with a portion of the water, and added after the emulsion is nearly finished. Alkaline solutions generally aid emulsification, by forming soaps with the resinous or oily liquids; volatile oils make better emulsions if they are first mixed with an equal volume of fixed oil."

There is no obvious reason why a pharmacist should be interested in preparing an emulsion containing water as drops and therefore it is not surprising to find that the emulsions, referred to in Remington's book, are all of the other type. I confess to being puzzled by the statement that the proportion of 4 : 2 : 1 for oil, water and gum is exactly right. Since the relative amounts of oil and water can vary within wide limits, there is no such thing as a best ratio unless one specifies an emulsion of definite properties, which is probably what was meant though it was not so stated. Even then, the statement is misleading because different gums have different emulsifying powers, and a proportion which is the best for one gum will not be the best for another. The matter seems to be expressed more clearly by Scoville.<sup>1</sup>

"Acacia is the emulsifying agent *par excellence* for general use. Emulsions made with it are attractive in appearance, palatable, and permanent. Its range of power is exceeded only by the albuminous agents mentioned (milk and yolk of egg). Emulsion of chloroform, oleoresins, resinous tinctures, etc., can be made readily with acacia, but separates into layers quicker than when made with yolk of egg.

<sup>1</sup> "The Art of Compounding," 88 (1895).

"Either dry acacia or mucilage of acacia can be used for emulsions. Both have their advocates in point of preference, but dry acacia has proved itself a quicker and more certain agent to use, at least in the hands of novices. This is probably due to the fact that dry acacia must always be used in definite proportions, as must also the water first added. Two rules are in common use for making emulsions with dry acacia.

"Rule 1.—For one part of gum use four parts of fixed oil (or *two* parts of *volatile oil*), and once and a half as much water as gum. Rule 2 varies only in using twice as much water<sup>1</sup> as gum. Exceptions to these may be met with in that the proportions of oil to gum vary with different oils; most fixed oils being emulsified well in proportion of four of oil to one of gum, while most volatile oils require one of gum to two of oil. Occasionally, however, a fixed oil is found which requires one-third its weight of acacia, or a volatile body which requires an equal weight. The amount of dilution to which the primary emulsion is subject also affects the proportions. In all cases, once-and-a-half or twice as much water as gum must be used for the primary emulsion."

"Tragacanth is, next to acacia, the most popular emulsifying agent. It is a type of the 'insoluble gums' and consists of a small proportion of true gum which dissolves in water and forms a very tenacious mucilage, and a large proportion of *bassorin*, or insoluble gum, which swells enormously in water, but does not dissolve. Thus a mucilage of tragacanth, if made by treating one part of the gum with twenty parts of water, is a thick gelatinous semi-solid, which is capable of occluding a large amount of oil, the *bassorin* being an obstacle to coalescence rather than a coating for the oil. It forms dense emulsions, which are not as white and creamy as those made with acacia, and will not bear as much dilution. Tragacanth is capable of emulsifying 40 to 50 times its weight of oil, but it is not often used alone, as the emulsions are too

---

<sup>1</sup> [This is Remington's rule.]

thick to be agreeable. It is frequently combined with acacia as a means of cheapening the emulsion and, also to prevent separation into layers by thickening it. Various proportions of tragacanth and acacia may be made into a mucilage into which the oil is stirred, as in using mucilage of acacia. Tragacanth is specially useful for suspending heavy powders, like bismuth subnitrate, etc., in mixtures."

In another part of the same book, the theory of emulsification, as seen by the pharmacist, is brought out so clearly, together with the difficulties incurred, that I quote it.<sup>1</sup>

"An emulsion may be defined as an intimate mixture of immiscible fluids, or a fluid and an insoluble solid, by means of some intermediate agent. They are milky-appearing mixtures, usually somewhat viscid, and often separate into two layers on standing. The term is usually applied to mixtures of oil or fatty bodies with water, but is also applied to intimate milky mixtures of fluids which are insoluble in each other (as chloroform, benzine, etc., with water), or to the suspension of an insoluble powder in water by means of an emulsifying agent.

"Among the many branches of extemporaneous pharmacy, perhaps none is more of a bugbear to the average dispenser than the making of emulsions. If he be ignorant of the principles and rules governing emulsification, he quickly comes to look upon them as unstable mixtures of uncertain composition obtained by chance or unlimited muscle used in triturating or agitating. The making of an emulsion, with a proper emulsifying agent, is, however, almost as positive and certain an operation as the making of a 50 percent solution of a salt, or of any other simple mixture. Let us first consider the theory of emulsification, then the practical operations involved in making emulsions of different kinds. If we place half an ounce of a fixed oil, as cod-liver oil, in a two-ounce bottle add to it half an ounce of water and shake vigorously, the oil is broken up into globules and diffused through the water,

---

<sup>1</sup> Scoville: "The Art of Compounding," 81 (1895).



and the mixture has an opaque appearance. On discontinuing the agitation, however, the oil and water quickly separate into layers again. This is due to two causes: the lack of adhesion between the globules of oil and water, and the difference in specific gravity. If now we place in another two-ounce bottle half an ounce of mucilage of acacia, turn the bottle so as to flow the mucilage around the inner sides, then add half an ounce of oil and shake vigorously, we obtain a whiter and more opaque mixture than before, which remains permanent for a period varying with the condition of the oil, the density of the mucilage, and the vigor of the shaking which we have given to it. Here we have broken up the globules of oil as before, but we have also coated each globule, while in a fine condition, with a film of mucilage, which forms a medium of adhesion between the oil and the water in the mucilage, and an emulsion ensues, although the difference in specific gravity is greater than in the first case.

"The foundation of an emulsion, then, consists in breaking up the cohesion of the oil as much as possible and getting it into fine globules which are then coated with a gummy or albuminous substance, as a pill is coated, whereby adhesion is established between the globules of oil and the water and a homogeneous mixture results. If the globules of the oil are not small enough, the cohesion of the oil will gradually reestablish itself, particle will coalesce with particle, until at length a more or less complete separation of the oil has taken place. The permanence of an emulsion consists in obtaining the globules of oil in so fine a condition that even a very thin mucilage can prevent their coalescing. These globules are ordinarily too small to be seen with the naked eye, but in emulsions made with a thick mucilage, as mucilage of tragacanth, or mucilage of Irish moss, the globules of oil may be distinctly visible to the eye and yet the emulsion remain permanent, owing to the viscosity of the mucilage which envelopes them. Such emulsions, however, will not bear very much dilution.

"The most difficult part of emulsion-making lies in getting



the emulsion started. Thus, in making a pint of 50 percent emulsion it would be extremely difficult, if not impossible, to do it all in one operation, but by emulsifying a portion or the whole of the oil with a portion of the water and the emulsifying agent, we get a *primary emulsion* which can be diluted with oil, water or other solution as desired. Good emulsions often separate into layers after standing, but without showing any separated oil. An emulsion should not be condemned for this, because the separation is due not to faulty manipulation in making the emulsion, or to improper ingredients or proportions therein, but to excess of dilution, and a little shaking will quickly rediffuse it. The same thing occurs in milk—the best type of a natural emulsion—in which the true emulsion portion separates as cream. When separation of this *emulsion* occurs, we obtain the fat as butter.

“In triturating an emulsion, no pressure is needed, but a rapid motion is essential. Five minutes of very rapid trituration will accomplish more in emulsifying an oil or balsam, than an hour of slow trituration. Indeed, if after five minutes or less of rapid trituration an oil does not emulsify it is good evidence of some fault in the ingredients used or of their proportions, and a satisfactory emulsion cannot be expected without alteration of the ingredients. This refers, of course, to small quantities of emulsion, involving a pint or less of oil. Large quantities require longer trituration. The pestle should be held loosely between the thumb and first two or three fingers, and the motion imparted to it by means of the fingers and wrist, as well as those of the arm and shoulder. This will be found much less tiresome than when the pestle is grasped firmly with the whole hand, and the motion imparted from the arm and shoulder alone. The mortar should be of a capacity three to four times that of the quantity of emulsion which is being made, but the emulsion should be slopped up on the sides as little as possible. An egg beater is often a very convenient instrument for making small quantities of emulsions. Glass mortars are not suitable, the surface being too smooth. The emulsion may be stirred in either

direction, or alternately. Alternating, or stirring first in one direction then in the other, is not desirable, however, except as a relief to the muscles, since emulsification takes place a little quicker when stirred in one direction only.

"Of late years emulsions containing 90 or 95 percent of oil have appeared upon the market. These are solid, cheesy bodies, not particularly agreeable to the palate, and they do not keep well. Some of them are soaps, or a combination of soap with the oil. Apparently the only advantage which these possess is that they may be quickly and easily diluted to any required strength, but this is quite offset in the average store by the losses occasioned through separation of the strong emulsion.

"All emulsifiable bodies do not emulsify with equal ease. Fixed oils, as cod-liver oil, castor oil, seed oils, etc., emulsify more readily than volatile oils, as turpentine oil, the fragrant oils, etc. Many bodies, as creosote, camphor, some oleoresins, phosphorus, etc., cannot easily be emulsified alone, but can readily be made into an emulsion if first dissolved in a fixed oil, which is then emulsified. Almond oil (sweet) is an excellent solvent for this purpose, being bland and seldom rancid. *All emulsions are easily separated by overagitation, heat, foreign bodies, etc.*

"It is well known that butter is made from milk by long-continued agitation. In the same way oil may be separated from a good emulsion by over-manipulation. Do not stir an emulsion longer than is necessary to thoroughly emulsify the oil. Heat will sometimes prevent the union of an emulsion. This is not liable to occur, though, except in cases where artificial heat has been employed. Neutral salts, acids and acid salts, alcohol, glycerin, etc., are incompatible with emulsions. Small amounts of any of these may be combined (in solution) with an emulsion, if carefully manipulated. The oil should be thoroughly emulsified and the emulsion diluted as much as the formula will allow, then the salt solutions, alcoholic liquids, etc., added last and slowly. If separation begins a few drops of water flowed down the pestle

and quickly stirred in may restore it. Acids and acid salts are the most troublesome to add, particularly if the emulsion is made with a gum. Emulsions made with tincture of quillaja will mix with these easier. Alkaline salts sometimes assist in emulsions, but it is safer to add these last when gum is present, as in case of neutral salts, since alkali salts sometimes act in the opposite way upon gum emulsions. Volatile bodies, as chloroform, ether, etc., should be emulsified by shaking in the bottle to prevent loss by evaporation, but non-volatile bodies are best emulsified in a mortar."

The general results of this paper are as follows:

1. By adding considerable quantities of caustic soda to a mixture of olive oil and water, Robertson has been able to make a few emulsions in which water was the inner phase. This type of emulsion was obtained only at the oil end and the emulsifying agent was presumably sodium oleate.

2. By using an especially efficient shaker, Robertson was able to start with all the ingredients at once and to emulsify the mass. This is never possible in cases where the shaking or stirring is done by hand.

3. Robertson believes that a change from one type of emulsion to the other necessarily takes place at or about a given concentration. This is not the case unless the emulsifying agent is miscible to some extent with both liquids.

4. Pharmaceutical emulsions, so far as known, are all of the oil in water type. Emulsions of this type, containing ninety-five percent oil, were prepared years ago by the pharmacist.

5. The pharmacist looks upon an emulsion essentially as consisting of minute drops of oil, each one in a tiny capsule, and the whole lot suspended in water.

6. There is no such thing as an ideal proportion of oil, water and gum, though the literature might lead one to think so.

7. In pharmaceutical emulsions, the emulsifying agents are chiefly albuminous, mucilaginous, or saponaceous in character.

*Cornell University*

## OSMOSIS IN SOILS. SOILS ACT AS SEMI-PERMEABLE MEMBRANES. I<sup>1</sup>

BY C. J. LYNDE, Ph.D., Professor of Physics, Macdonald College, P. Q., Canada

It is usually stated that the water in the soil is subject to three types of movement, namely: gravitational, capillary and thermal. The experiments described below go to show that soil water is subject to a fourth type of movement, namely, an osmotic movement.

These experiments show for the first time:

- (1) that soil acts as a semi-permeable membrane;
- (2) that water is moved through the soil by osmotic pressure.

Before describing the experiments it may be well, for the sake of clearness, to review briefly the epoch-making work of Pfeffer, van't Hoff and Arrhenius.

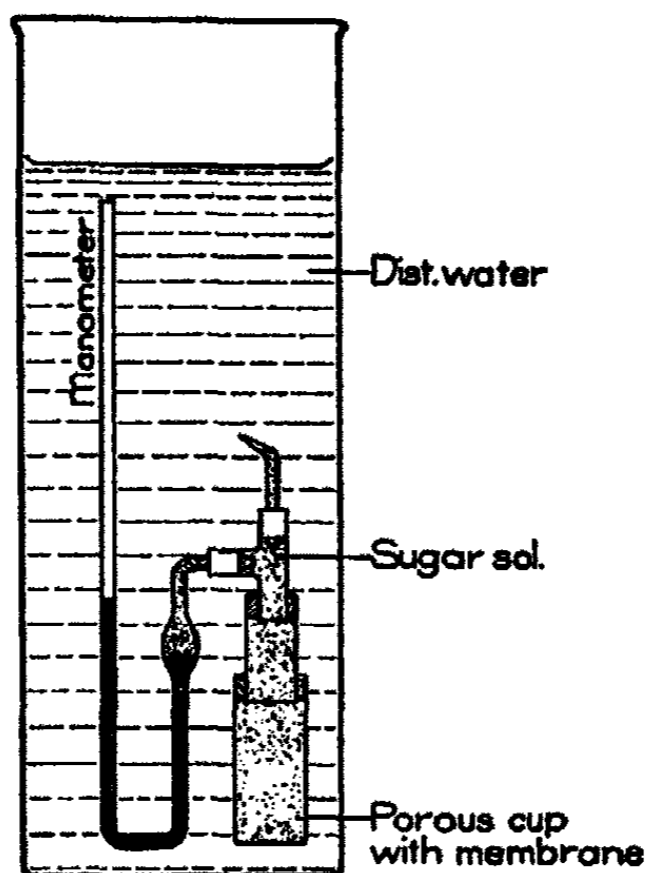

Fig. 1.—Pfeffer's apparatus.

<sup>1</sup> Read before the American Society of Agronomy, Lansing, July 11, 1912.

In 1877 W. Pfeffer<sup>1</sup> measured the osmotic pressure of various solutions and, showed:

(1) That with dilute solutions of the same substance, the osmotic pressure is directly proportional to the concentration of the solution.

(2) That for a given solution the osmotic pressure increases with the temperature.

Pfeffer used the apparatus illustrated in Fig. 1. The semi-permeable membrane was a precipitate of copper ferrocyanide deposited within the walls of an unglazed porcelain cup. The osmotic pressure was measured by means of a closed-arm manometer.

With cane sugar solutions ranging in concentration from 1 to 6 percent, he obtained the following results at 14° C.:

TABLE 1

Concentration Percent	Osmotic pressure Cm	Pressure Concentration
1	53.5	55.5
2	101.6	50.8
4	208.2	52.0
6	307.5	51.2

The figures obtained for  $\frac{\text{pressure}}{\text{concentration}}$  are nearly constant, which goes to show that the osmotic pressure varies directly as the concentration of the solution.

■ Pfeffer measured the osmotic pressure of given solutions at different temperatures. The results with a 1 percent cane sugar solution were as follows:

TABLE 2

Temp. C	Osmotic pressure Cm
6.8°	50.5
13.2°	52.1
14.2°	53.1
22.0°	54.8
36.0°	56.7

<sup>1</sup> Osmotische Untersuchungen, Leipzig, 1877.

These results show that the osmotic pressure of the solution increases with increase of temperature.

In 1887 van't Hoff<sup>1</sup> reviewed Pfeffer's results, and pointed out the remarkable parallelism between osmotic pressure and gas pressure.

He showed from Pfeffer's results that:

1. At a given temperature, the osmotic pressure of a sugar solution is equal to the gas pressure of a gas which has the same number of molecules in a given volume as there are sugar molecules in the same volume.

2. The osmotic pressure and gas pressure change at the same rate for equal changes of temperature, namely,  $1/273$  of the pressure at  $0^{\circ}\text{C}$  for each change of  $1^{\circ}\text{C}$ .

This relation has been found to hold for a large number of substances.

Van't Hoff pointed out, moreover, that there are many substances such as acids, bases and salts which give higher osmotic pressures than should be expected from the relations stated above.

To explain these exceptions, Arrhenius<sup>2</sup> in 1887 brought forward the theory of electrolytic dissociation which had been previously stated by Clausius.<sup>3</sup> This theory states that acids, bases and salts in aqueous solution are more or less dissociated into positively and negatively charged particles or ions. Arrhenius assumed that each ion has the same effect as a molecule in producing osmotic pressure, and that the increase in the number of particles by dissociation accounts for the increase in osmotic pressure.

Arrhenius further pointed out that the percentage of the molecules dissociated could be determined by measurements of the electrical conductivity, and of the lowering of the freezing point of the solution.

---

<sup>1</sup> Zeit. phys. Chem., 1, 481 (1887).

<sup>2</sup> Ibid., 1, 631 (1887).

<sup>3</sup> Pogg. Ann., 101, 338 (1857).

### Experiments

In introducing the experiments, I may say that, in studying the movement of moisture in soils, I was gradually led to the conclusion, that, in producing the movement of moisture in soils, there must be an agency at work more powerful than either surface tension or heat. In considering what this agency might be, I was led to the following theory:

#### Theory that Soils Act as Semi-permeable Membranes

It is possible that:

- (1) Soils act as semi-permeable membranes.
- (2) The greater the depth of the soil the greater its efficiency as a semi-permeable membrane, up to the point at which it becomes a perfect semi-permeable membrane.
- (3) A soil solution moves through the soil by osmotic pressure from points where the solution is less concentrated to points where it is more concentrated.

To test the validity of this theory I made the experiments described below.

#### Modification of Pfeffer's Experiment

Object. (1) To determine whether a soil acts as a semi-permeable membrane, by making observations on the rate of osmotic flow of water through the soil, if any.

(2) To observe the effect, if any, of change of temperature upon the rate of osmotic flow.

The apparatus used is illustrated in Fig. 2. The tube A was 1.1 cm inside diameter, and 15 cm long. The lower end was closed with one layer of cotton cloth covered with brass wire gauze 40 mesh to the inch. The upper end of the tube was fitted with a rubber stopper in which was inserted the bent tube B. The bent tube B was approximately 1.5 mm inside diameter. Water, sugar solution and potassium sulphate solution rose in this tube 1.3 cm by surface tension.

Four tubes were prepared in this way.

The soil used was a heavy clay subsoil (a physical analysis of this soil appears in paper 2 below).

The air-dried subsoil was allowed to stand in water for

one week, and was then disintegrated and sterilized by boiling. The four tubes A were sterilized and filled with the hot mixture of subsoil and water. They were placed at once in the centrifuge, and the cups of the centrifuge were filled with boiling water to the level of the liquid in the tubes. The centrifuge was then run at top speed for 15 minutes. The middle of each soil column, when settled, was 25 cm from the center of the axis of the centrifuge, and the centrifuge made 1300 revolutions per minute.

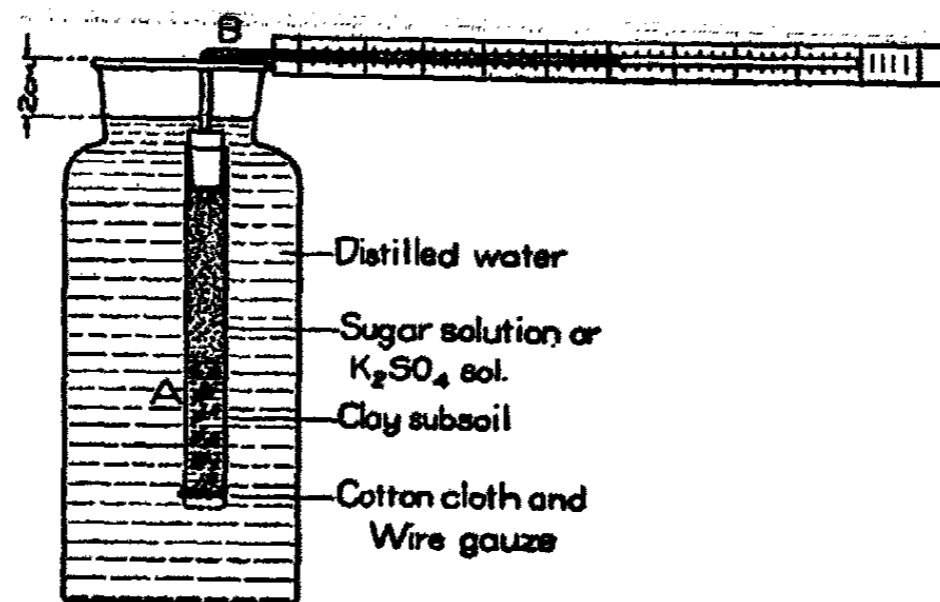

Fig. 2.—Modification of Pfeffer's apparatus. Clay subsoil acts as the semi-permeable membrane.

The solutions used were 10 percent sugar solution, and 10 percent potassium sulphate solution. The sugar solution was made by dissolving 100 grams of sugar in 1000 cc of solution. The potassium sulphate solution was made by dissolving 100 grams of potassium sulphate in 1000 cc of solution. Both solutions were sterilized by boiling for one-half hour.

As soon as the soils were settled, the liquid above them was emptied out, and the tubes were filled with hot sugar solution or hot potassium sulphate solution. The tubes were then fitted with the rubber stoppers and bent tubes B, which had been sterilized. The tubes were then washed on the outside and placed in wide-mouth bottles. The bottles were filled with distilled water to a level 2 cm below the lower side



of the horizontal tube. The tops of the bottles were covered with paper, fastened around the neck with rubber bands. A centimeter scale was placed under each horizontal tube to measure the osmotic flow, if any. The tubes were numbered 1, 2, 3, and 4. 1 and 2 were filled with sugar solution, 3 and 4 with potassium sulphate solution. The results were as follows:

TABLE 3

Date	Sugar solution Scale readings		K <sub>2</sub> SO <sub>4</sub> soln. Centimeters		Temp.
	Tube 1	Tube 2	Tube 3	Tube 4	
Started May 29, 1911					
May 29, 9.30 A.M.	26.0	26.8	23.3	28.5	24.5° C
30, 9.30 A.M.	26.2	27.25	22.2	28.7	21.5° C
31, 11.00 A.M.	26.5	27.65	21.75	29.25	21°
June 1, 9.30 A.M.	26.8	27.95	21.7	29.8	20.3°
2, 9.00 A.M.	27.1	28.15	21.75	30.35	18.5°
2, 9.00 A.M.	Moved the tubes to the incubator room. This necessitated a change in the position of the scales. Allowed tubes to stand until 5 P.M. before making readings.				
June 2, 5.00 P.M.	27.52 <sup>1</sup>	28.55	21.76	28.62	24.2°
3, 5.40 P.M.	27.83	28.83	21.63	29.7	24.4°
4, 4.30 P.M.	28.1	29.1	22.3	7.02 <sup>1</sup> 8.05	25° C
5, —	—	—	—	—	—
6, 10.10 A.M.	28.5	29.4	24.0	11.55	24° C
6, 5.15 P.M.	28.6	29.4	24.3	12.0	24.5° C
7, 4.45 P.M.	29.4	29.65	25.5	14.0	24° C
8, 7.15 P.M.	31.6	31.3	27.2	16.3	25° C

These results are represented graphically in Fig. 3 below.

#### Conclusions

These results indicate:

- (1) That clay subsoil acts as a semi-permeable membrane.
- (2) That water moves through clay subsoil towards a solution.

<sup>1</sup> Liquid reached end of horizontal tube; emptied the horizontal tube and started it again at 5.40 P.M., June 3rd.

(3) That the rate at which the water moves increases with the temperature.

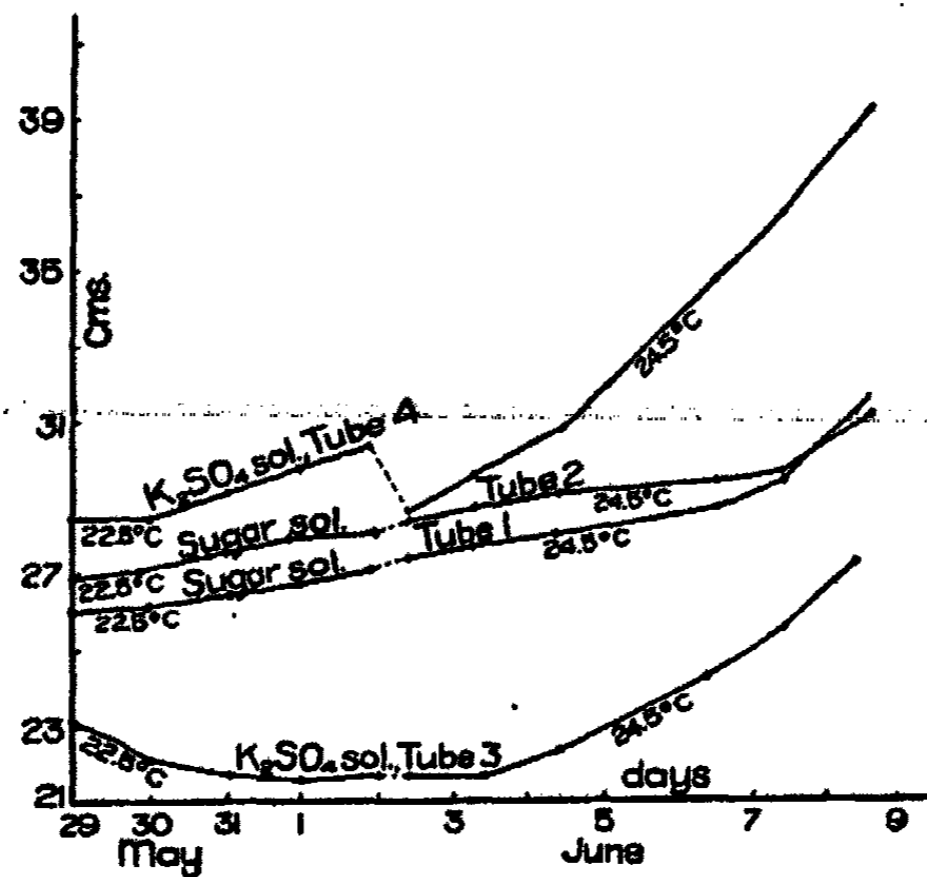

Fig. 3.—Graphs showing the movement of the solutions in the tubes B.

It will be noticed that in tube 3 the liquid fell back for the first six days, and then moved forward rapidly. It seems probable that in all cases there are two movements: the solution moving out of the tube by gravity, and the water moving towards the solution by osmotic pressure. If the osmotic movement of the water towards the solution is more rapid than the movement of the solution out of the tube, the liquid in the horizontal tube moves forward; if not, it moves back. It would seem that, in the case of tube 3, the movement of the solution out of the tube was the more rapid in the beginning, but that when the temperature was raised the osmotic movement of the water became the more rapid.

## OSMOSIS IN SOILS: SOILS ACT AS SEMI-PERMEABLE MEMBRANES. II<sup>1</sup>

BY C. J. LYNDE, Ph.D., AND F. W. BATES, M.Sc., Macdonald College, P. Q., Canada

The experiments outlined in the paper above were made in the spring of 1911. This spring Mr. Bates joined me and we made the following experiments.

### Experiments

The object of the experiments was:

*First.*—To determine again whether soil acts as a semi-permeable membrane.

*Second.*—To determine whether its efficiency as a semi-permeable membrane varies with the depth of soil column.

*Third.*—To measure the total osmotic pressure obtained in each case.

*Fourth.*—To find the influence of change of temperature upon the total osmotic pressure obtained in each case.

*Apparatus.*—The apparatus used is illustrated in Fig. 1 below. Six tubes were prepared as follows: Each of the tubes A, 1.1 cm inside diameter and 15 cm long, was covered at the lower end with one layer of cotton cloth. Each tube was fitted with a rubber stopper in which was inserted a glass tube between 1 and 2 mm inside diameter.

The tubes were numbered 1, 2, 3, 4, 5 and 6. A definite weight of clay subsoil was placed in each tube. In tubes 1 and 2, 6 grams; in tubes 3 and 4, 4 grams; in tubes 5 and 6, 2 grams.

The soil was prepared as follows: The quantity of soil to be used was weighed out in air-dry condition. It was then placed in distilled water in a test tube, and allowed to stand overnight. In the morning the test tubes were placed

<sup>1</sup> Read before the American Society of Agronomy, Lansing, July 11, 1912.

in water, and the water was boiled for 3 hours. In the meantime the tubes A, the rubber stoppers, and the tubes B were sterilized in boiling water. The hot mixture of soil and water was poured into the tubes A, and the soils were settled in the centrifuge for 30 minutes at top speed, as described in paper 1 above.

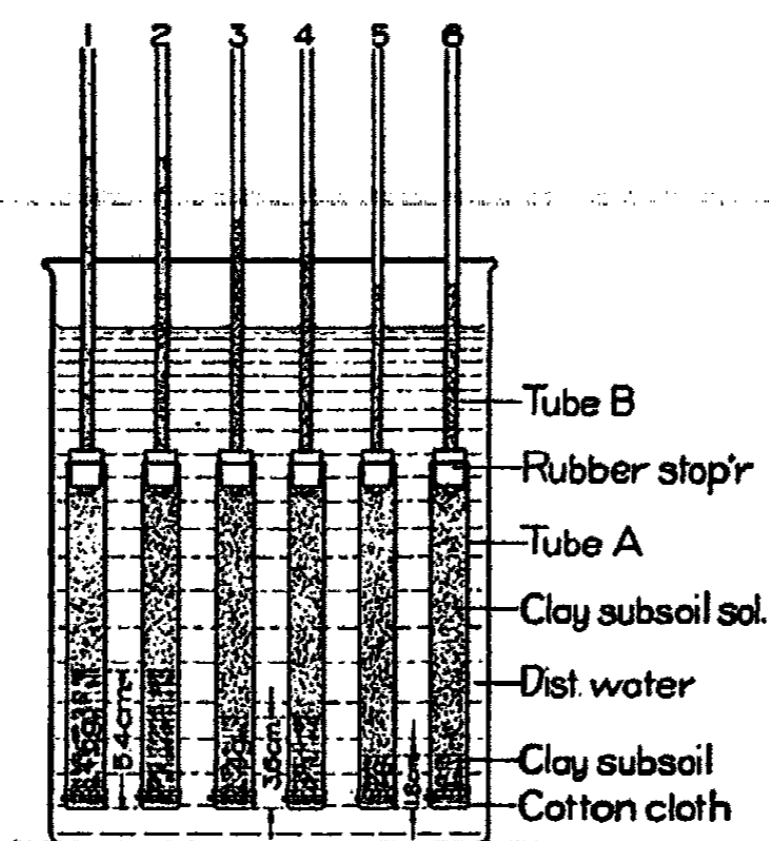

Fig. 1.—Modification of Pfeffer's experiment. The semi-permeable membranes are 6, 4, and 2 grams of clay subsoil, respectively. The solution is that formed by boiling clay subsoil in distilled water.

At the end of 30 minutes the rubber stoppers and tubes B were inserted in the tubes A, and the tubes were placed in distilled water.

*The Solutions.*—In each case the solution was a clay subsoil solution namely, the water with which each portion of clay subsoil was mixed and heated. This liquid remained above the soil when the soil was settled, and served as the solution.

In adjusting the rubber stoppers and tubes B, the level of the liquid in the tubes B was made about 3 cm above the

top of the rubber stoppers, and the level of the distilled water in the larger vessel was raised above the level of the solution in the tubes B. The height to which the solution rose in each tube B by surface tension had been measured previously. They are as follows:

TABLE I

Tube	1	2	3	4	5	6
Height in cm	1.6	1.25	1.1	1.7	1.45	1.35

The length of soil column in each tube A after being settled was as follows:

TABLE II

Tube	1	2	3	4	5	6
Length of soil column in cm	5.4	5.4	3.6	3.6	1.8	1.8

### Results

The tubes were started on May 1, 1912, at 11.30 A.M.

TABLE III

Date	May 4	5	6	7	8	9	10	11	12
Time	9.45 A.M.	9	9.30	8.45	9	8.45	9	9	9
Temp.	19.6°C	19° C	18.6°	18.2°	19.2°	19.2°	18.6°	18.8°	19.6°
Height in cms									
1	3.0	3.3	3.5	3.6	3.9	4.0	4.1	4.2	4.3
2	2.3	2.4	2.7	2.8	3.0	3.1	3.1	3.2	3.3
3	1.8	1.8	2.1	2.1	2.2	2.3	2.3	2.4	2.5
4	2.4	2.4	2.6	2.6	2.7	2.6	2.6	2.6	2.6
5	2.7	2.4	2.5	2.3	2.2	2.0	2.1	2.2	2.2
6	2.3	2.1	2.0	1.9	1.9	1.9	2.0	1.9	2.1

TABLE III (Continued)

Date	May 13	14	15	16	17	18	19	20	21
Time	9 A.M.	9	9	9	9	9	9	9	9
Temp.	20°	14.8°	15.2°	16.2°	16.5°	16° C	16.8°	16.3°	13.8°
Height in cms									
1	4.5	4.2	4.3	4.8	4.8	4.9	5.1	5.1	5.1
2	3.4	3.2	3.3	3.7	3.9	3.7	3.9	3.9	3.8
3	2.6	2.4	2.5	2.8	2.8	2.9	3.0	3.0	3.1
4	2.7	2.3	2.6	2.8	2.9	2.8	2.8	2.9	2.9
5	2.3	2.1	2.1	2.2	2.2	2.1	2.2	2.1	2.1
6	2.2	1.8	1.7	2.1	2.1	2.0	2.1	2.0	2.1

TABLE III (Continued)

Date	May 22	23		24	25	26	27	28	29
Time	9 A.M.	9		9	9	9	9	9	9
Temp.	16.5°	16.7°		35.8°	35.4°	36.8°	37.1°	37.4°	37.3°
Height in cms									
1	5.1	5.2	moved to incubator	5.8	5.5	5.7	5.9	6.2	5.8
2	3.9	4.0		4.5	4.7	5.0	5.2	5.4	5.4
3	3.0	3.1	9 A.M.,	3.6	4.0	4.4	4.8	4.9	5.0
4	2.9	2.9	May 23	5.3	5.2	5.6	5.7	5.9	5.8
5	2.1	1.9		2.7	2.6	3.0	3.1	3.3	3.0
6	2.1	1.9		2.6	2.6	2.7	2.9	3.0	2.9

TABLE III (Concluded)

Date	May 30	31
Time	9 A.M.	9
Temp.	36.1°	35.7°
Height in cms		
1	5.9	5.9
2	5.4	5.6
3	5.2	5.3
4	5.6	5.6
5	3.0	3.0
6	2.8	2.7

The results show:

- (1) That clay subsoil acts as a semi-permeable membrane.
- (2) That water moves through clay subsoil towards a solution.
- (3) That the greater the depth of the column of subsoil the greater its efficiency as a semi-permeable membrane.
- (4) That the total pressure increases with the increase of temperature.

*Analysis of Results.*—If we take the greatest height to which the solution rose, in one tube containing 6 grams of soil, in one containing 4 grams of soil, and in one containing 2 grams of soil, the heights are roughly proportional to the depths of the soil column. Before the apparatus was placed in the incubator, the average temperature was 16.7° C. In the incubator it was 36.5°.

TABLE IV

	Tube 1	Tube 3	Tube 5
Weight of soil in tubes in grams	6	4	2
Depth of soil column in cm	5.4	3.6	1.8
Height the solution rose at 16.7° C, cm	5.2	3.1	2.7
Height the solution rose due to surface tension, alone, cm	1.6	1.1	1.45
The difference equals height the solution rose due to osmotic pressure	3.6	2.0	1.25

The length of soil columns is 5.4, 3.6, and 1.8 cm, respectively. The heights due to osmotic pressure are 3.6, 2.0 and 1.25 cm, respectively. That is, the efficiency of the soil column as a semi-permeable membrane is roughly proportional to the depth of the column.

In the incubator the greatest heights were as follows:

TABLE V

	Tube 1	Tube 4	Tube 5
Weight of soil in tubes, in grams	6	4	2
Depth of soil column, in cm	5.4	3.6	1.8
Height the solution rose at 36.5° C	6.2	5.9	3.3
Height the solution rose due to surface tension alone, cm	1.6	1.7	1.45
The difference equals the height the solution rose due to osmotic pressure	4.6	4.2	1.85

In this case the temperature is higher, and the pressures developed are greater than they were in the same tubes at the lower temperature.

Here again the greater the length of the soil column, the greater its efficiency as a semi-permeable membrane, but the proportion is not so close as it is at the lower temperature.

#### Electrical Resistance of the Soil Solutions

We measured the electrical resistance of the soil solution at 16.7° C and at 36.5° C and at the same time the resistance of a 0.02 *N* KCl solution at 16.7° C.

These measurements enabled us to obtain an idea of

(1) The total osmotic pressure which the solutions should develop if the soil column were a perfect semi-permeable membrane.

(2) The percent efficiency of the soil column as a semi-permeable membrane.

(3) The depth of soil column which should act as a perfect semi-permeable membrane,

The electrical resistances of the solutions were as follows:

TABLE VI

Solution in	At 36.5° C	At 16.7° C
Tube 1	52 ohms	75 ohms
Tube 2	47 ohms	71 ohms
Tube 3	51 ohms	75 ohms
Tube 4	54 ohms	77 ohms
Tube 5	57 ohms	81 ohms
Tube 6	56.5 ohms	81 ohms
0.02 <i>N</i> potassium chloride solution at 16.7	= 11.5 ohms	



The molecular lowering of the freezing point of a KCl solution containing 0.02 gram molecules per liter is  $3.58^{\circ}\text{C}$ . The molecular lowering of the freezing point of a dextrose solution containing 0.0198 gram molecules per liter is  $1.84^{\circ}\text{C}$ .

The abnormal effect of KCl upon the freezing point is due to the fact that the KCl is dissociated in solution. A KCl solution containing 0.02 gram molecules per liter has the same effect as a dextrose solution containing  $0.0198 \times \frac{3.58}{1.84} = 0.038$  gram molecules per liter.

**NOTE.**—It must be noted here that we determined the resistance of a 0.02 *N* KCl solution, that is, of a solution in which 0.02 gram molecules of KCl are dissolved in 1000 cc of solution, whereas the molecular lowering of the freezing point given above, was determined for a solution containing 0.02 gram molecules of KCl in 1000 cc of water. This introduces a slight error. But an assumption which we make later, namely, that the salts in the soil solution are dissociated to the same extent as the 0.02 *N* solution of KCl, probably introduces a greater error. We, therefore, cannot claim that the results of these calculations are more than an approximation.

Since the freezing point lowering and the osmotic pressure of a solution are both proportional to the total number of particles (molecules and ions) in a given volume of the solution, a 0.02 *N* KCl solution produces the same osmotic pressure as a dextrose solution containing 0.038 gram molecules per liter.

#### **The Efficiency of the Soil Columns as Semi-permeable Membranes**

One gram molecule of dextrose dissolved in 22.4 liters of water at  $0^{\circ}\text{C}$  produces an osmotic pressure of 1 atmosphere or 1033.6 grams per square cm, therefore 0.038 gram molecules in 1 liter at  $16.7^{\circ}\text{C}$  produces an osmotic pressure of  $\frac{1033.6 \times 0.038 \times 22.4 \times 289.7}{273} = 933.6$  grams per sq. cm.

This is the pressure that should be produced at  $16.7^{\circ}\text{C}$  by 0.038 gram molecules of sugar in 1 liter of water or by a

0.02 *N* solution of KCl, if the semi-permeable membrane were perfect.

Let us assume that the salts in the soil solutions are dissociated to the same extent that the 0.02 *N* KCl solution is. We can then calculate from their electrical resistances the osmotic pressure that these solutions should develop with a perfect semi-permeable membrane, and then the efficiency of the soil columns as semi-permeable membranes.

Referring to Tables IV and VI, in tube 1 at 16.7° the resistance of the solution is 75 ohms and the osmotic pressure is 3.6 grams per sq. cm. The resistance of the 0.02 *N* KCl solution is 11.5 ohms at 16.7° C.

The soil solution in tube 1 should, under the same conditions, develop an osmotic pressure of

$$9.33.6 \times \frac{11.5}{75} = 143.1 \text{ grams per sq. cm.}$$

With the soil column acting as a semi-permeable membrane, the solution develops a pressure of 3.6 grams per square centimeter. Therefore the soil column, 5.4 cm long, has an efficiency as a semi-permeable membrane of  $\frac{3.6 \times 100}{143.11} = 2.5$  percent. Similar calculations for the other soil columns give the following results:

TABLE VII

	Tube 1	Tube 3	Tube 5
Length of soil column, cm	5.4	3.6	1.8
Resistance of soil solution at 16.7 C, ohms	75	75	81
Osmotic pressure with a perfect semi-permeable membrane grams per sq. cm	143.1	143.1	120.2
Osmotic pressure observed, grams per sq. cm	3.6	2.0	1.25
Percent efficiency of the soil column as a semi-permeable membrane	2.5	1.4	1.0

### Depth of Soil Column Which Would be a Perfect Semi-permeable Membrane

If we assume that the efficiency of a soil column as a semi-permeable membrane is directly proportional to its depth, then the depth of soil column required in each tube to produce a perfect semi-permeable membrane is as follows:

In tube 1, a soil column 5.4 cm deep has an efficiency of 2.5 percent, therefore a soil column  $5.4 \times \frac{100}{2.5} = 216$  cm deep would be a perfect semi-permeable membrane.

In tube 3, a soil column 3.6 cm deep has an efficiency of 1.4 percent, therefore a soil column  $3.6 \times \frac{100}{1.4} = 257$  cm long would be a perfect semi-permeable membrane.

In tube 5, a soil column 1.8 cm long has an efficiency of 1 percent, therefore a soil column  $\frac{1.8 \times 100}{1} = 180$  cm long would be a perfect semi-permeable membrane.

### Experiment Repeated

The soil solutions used above were thrown away after their electrical resistances had been determined. The tubes were then scalded on the outside with boiling water. They were then filled with boiling distilled water, placed in distilled water and started again. The distilled water in the tubes were left to form a new clay subsoil solution in each tube.

They were started on May 31, 1912, and allowed to run until July 6th at room temperature, average 25° C. The highest pressures developed were as follows:

TABLE VIII

	Tube 1	Tube 2	Tube 3	Tube 4	Tube 5	Tube 6
Weight of soil, grains	6	6	4	4	2	2
Length of soil column, cm	5.4	5.4	3.6	3.6	1.8	1.8
Total height, cm	5.4	4.8	4.2	4.4	2.4	2.5
Height due to surface tension	1.6	1.25	1.1	1.7	1.45	1.35
Height due to osmotic pressure	3.8	3.55	3.1	2.7	0.95	1.15

It will be seen that the pressures developed are in the same order as in the previous experiment, but a little higher in each case because the temperature ranged somewhat higher.

#### Experiment with 12 Grams of Subsoil in Each Tube

On May 13, 1912, we started two tubes, each containing 12 grams of clay subsoil, prepared and settled as in the experiment above. The soil column in each was 10.8 cm long, or twice as long as those in tubes 1 and 2 above. The solution was a clay subsoil solution as above. The solution in the tubes was still rising on July 7th. The measurements on that date were as follows:

TABLE X

	Tube 1	Tube 2
Weight of soil, grams	12	12
Length of soil column, cm	10.8	10.8
Total height, cm	6.9	7.2
Height due to surface tension	1.7	1.6
Height due to osmotic pressure	5.2	5.6

The solution is still rising, but it has already gone far enough to give further evidence that the efficiency of a soil as a semi-permeable membrane increases with the depth.

#### Physical Analysis of Clay Subsoil

The physical analysis of the clay subsoil used in all the experiments above gave the following results:

Sand 2 mm-1 mm	1.48%
Sand 1 mm-0.5 mm	1.05%
Sand under 0.5 mm	7.96%
Silt	50.42%
Clay	36.28%
Organic matter	2.81%
	<hr/> 100.00%

#### Experiments with Other Subsoils

On June 3, 1912, we started experiments with three subsoils taken from different parts of the Macdonald College

Farm. The physical analyses of these soils gave the following results:

Table	Soil 1	Soil 2	Soil 3
Sand over 1 mm	1.7%	0.5%	0.6%
Sand 1 mm-0.5 mm	2.2	4.1	4.9%
Sand under 0.5 mm	40.9	49.1	55.4%
Silt	41.3	29.5	23.0
Clay	12.2	15.8	15.0
Loss	1.7	1.0	1.1
Organic matter separate determination	6.08	4.2	2.8

Duplicate experiments were made with each soil. Each tube contained 6 grams of soil settled as in the experiments above. The soil solution was again the water in which the soil was boiled. The results on July 5th were:

Table	Soil 1		Soil 2		Soil 3	
	Tube 1	Tube 2	Tube 3	Tube 4	Tube 5	Tube 6
Total height cm	1.3	1.1	1.3	2.1	1.1	1.3
Height solution rose due to surface tension	1.6	1.6	1.6	1.6	1.6	1.6
Height due to osmotic pressure	-0.3	-0.5	-0.3	+0.5	-0.5	-0.3

In only one case is there any evidence of osmotic pressure. In tube 4 there is a rise of 0.5 cm. It will be noticed that in these soils the percentage of sand is high and the percentage of clay, low. This may account for the lack of osmotic pressure.

#### Conclusions

Our experiments show that for clay subsoil prepared as above the following is true:

- (1) The soil acts as a semi-permeable membrane.
- (2) The efficiency of the soil as a semi-permeable membrane increases with the depth.

(3) Water moves through the soil towards a solution and develops a certain osmotic pressure.

(4) The osmotic pressure developed increases with the temperature.

*Application of the Theory.*—The theory as given in paper I states: that the soil acts as a semi-permeable membrane; that its efficiency as a semi-permeable membrane increases with its depth; and that moisture moves through it from points of low concentration to points of high concentration.

Our experiments substantiate this theory only for the case of a heavy clay subsoil prepared in a certain way. It remains yet to show that it holds for soils under field conditions.

If we consider the application of the theory to agricultural practice in general, we find that it is suggestive in many ways, as follows:

*Tillage.*—If we consider the different operations of tillage: ploughing, harrowing, etc., these stir up the soil and permit air to enter. This makes the conditions more favorable for the growth of bacteria; the bacteria produce plant food, that is, salts soluble in water; this increases the concentration of the soil solutions in the upper layers of soil. This in turn increases the osmotic pressure of these solutions, and therefore increases the amount of water raised from the lower depths through the subsoil (see Fig. 2).

We see, then, that the theory suggests an explanation of the benefits of tillage.

*Drainage.*—It is well known that crops on drained land receive more moisture than crops on underdrained land. This may be due to a deeper root system, but it may also be due to the following:

In drained land the water level is lowered to a depth of 3 or 4 feet below the surface. This permits air to enter to this depth. The conditions then are more favorable to the growth of bacteria, the bacteria produce more soluble salts, which increase the concentration of the soil solutions. The soil solutions in the upper 3 or 4 feet then have a greater

osmotic pressure, and lift a larger amount of water from below through the subsoil.

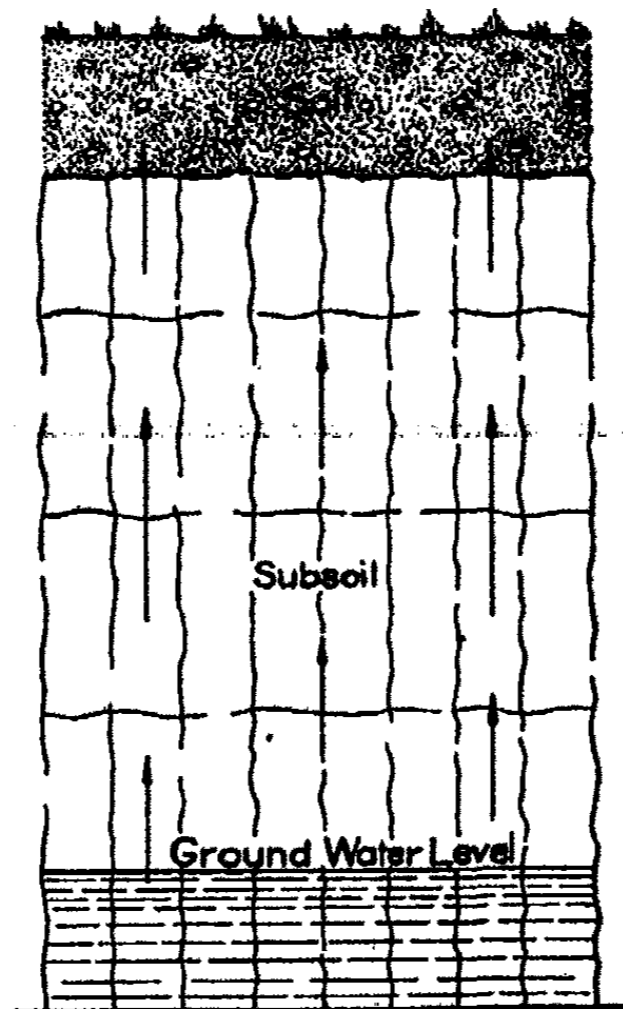

Fig. 2.—Diagram illustrating the movement of moisture in the soil by osmotic pressure. An increase in the concentration of the soil solutions, brought about by any means, increases the amount of moisture raised by osmotic pressure. The arrows represent moisture rising by osmotic pressure.

We see then that the theory offers an explanation of the greater amount of moisture received by plants on drained land.

*Manure.*—Experiments made by King<sup>1</sup> show that in land, treated with manure well worked in, the rise of moisture is stronger than in land not so treated. This cannot be due to a greater capillary rise, because manure added to water decreases the surface tension of the water.

<sup>1</sup> Wisconsin station report, 1893, pp. 167-200.

Our theory offers an explanation. The manure added to the soil increases the amount of food available for bacteria. The increased number of bacteria produce a larger supply of plant food, in the form of soluble salts. This increases the concentration and therefore the osmotic pressure of the soil solutions near the surface. The increased osmotic pressure increases the amount of moisture raised through the subsoil (see Fig. 2).

*Mineral Fertilizers.*—When mineral fertilizers are added to the land, the concentration of the soil solutions near the surface is increased. This increases the osmotic pressure of these solutions, and, according to our theory, should increase the amount of moisture raised through the subsoil.

This may be one of the beneficial results obtained by adding mineral fertilizers to the land.

It may also explain one of the benefits of adding to the soil, fertilizers which are not directly plant foods, such as gypsum and salt.

*Increase of Temperature.*—If the rise of moisture in soil is all brought about by capillary action, then the supply in summer should be less than that in spring or fall, because the surface tension of water decreases with an increase in temperature. That is, the supply of moisture to plants should be least when they most need it. It is true that the decrease in surface tension is offset to some extent in two ways: by the increase in concentration, by evaporation of the solutions near the surface which increases the surface tension, and by the increase in fluidity of the water at higher temperatures.

If, however, the rise of water is due partly to osmotic pressure, the supply of water would be increased by an increase in temperature in a number of ways (see Fig. 2).

(1) The increased evaporation would increase the concentration, and therefore the osmotic pressure of the solution near the surface. This would increase the amount of water raised through the subsoil.

(2) The increased bacterial action, at higher temperatures, would increase the concentration and osmotic pressure



of the soil solutions. This would increase the amount of water raised through the subsoil.

(3) With increase of temperature more soluble salts would be dissolved in the soil solution, and their osmotic pressure would thereby be increased. This again would increase the amount of water raised through the subsoil.

(4) The osmotic pressure of any solution is increased by an increase of temperature. This would be the case with the soil solution.

We see then that the osmotic pressure of the soil solutions near the surface would be increased by an increase of temperature. This would increase the amount of water raised from below through the subsoil. That is, in summer when the plants need more water, they would receive it.

*The Soil Mulch.*—A soil mulch conserves the moisture in the land for the benefit of the crop. Our theory suggests another way in which the amount of water under the mulch is increased, as follows: Bacteria thrive where there is moisture as well as heat. If the soil is dry the bacteria remain dormant. Under a soil mulch the land is moist and warm. These are the ideal conditions for bacterial growth. Under the mulch then the bacteria produce plant food and increase the osmotic pressure of the soil solutions as described above. This increased osmotic pressure would increase the amount of water raised through the subsoil.

That is, one of the benefits of a soil mulch may be that a greater amount of moisture is raised from below by osmotic pressure.

*Dry Farming.*—In dry farming it is the practice in some cases to plant a crop every other year, and to maintain a mulch on the land in the off year. The explanation of the benefit of this is that the moisture is held over for the crop the succeeding year.

Our theory suggests that the increased crop the second year may be due partly to the increase in the osmotic pressure of the soil solutions near the surface due to bacterial action, as explained under soil mulch above.

The explanation of the increase in crop may be that water is drawn from a greater depth in land that has been mulched.

**Opens Large Field for Investigations**

The theory then suggests one benefit derived from the ordinary operations of cultivation: tillage, underdrainage, the use of fertilizers, and soil mulching.

It also opens up a large field for investigation in soils, as follows:

(1) Do soils other than clay subsoil act as semi-permeable membranes?

(2) Does the efficiency of a soil as a semi-permeable membrane depend upon the percentage of clay it contains? If so, how?

(3) Do soils under field conditions act as semi-permeable membranes?

(4) Does a higher salt content increase the water holding capacity of soils?

(5) Do the operations of tillage: ploughing, harrowing, etc., increase the amount of water raised through the subsoil?

(6) Do fertilizers increase the amount of water raised through the subsoil?

(7) Does underdrainage increase the amount of water raised through the subsoil?

(8) Does a soil mulch increase the amount of water raised through the subsoil?

(9) In dry farming, does the mulch used one year increase the depth from which water is raised to the plants, the next year?

(10) Are there substances, other than those at present known, which are not plant foods but which can be used as fertilizers with benefit?

(11) In the domain of pure physics, it is possible that the experiments described above may throw light upon the action of semi-permeable membranes in general and upon the cause of osmotic pressure.

## PHOTOCHEMICAL REDUCTION OF COPPER SULPHATE<sup>1</sup>

BY CHARLES W. BENNETT

Since light tends to eliminate the substances by which it is absorbed, it follows that those wave lengths, which are absorbed by a solution of copper sulphate, tend to precipitate copper from it. The work necessary to set free copper under these conditions is so great that no precipitation of copper takes place even in the strongest light. It should be possible, however, to obtain metallic copper by the action of light on a copper sulphate solution, if one added to the solution a reducing agent which was just not strong enough to precipitate copper in the dark. The light would then be able to do the balance of the work necessary to cause reduction to metallic copper.

Several reducing agents were tried in an attempt to find a suitable one. Hydrazine sulphate forms a sparingly soluble blue compound with copper sulphate and is therefore unsuitable. Hydroxylamine hydrochloride also causes the precipitation of an insoluble compound. The decomposition products of pyrogallol, as well as those of hydroquinone, in alkaline solution prevented satisfactory work with these reagents. If copper sulphate or copper acetate be made ammoniacal and if enough hydrazine hydrate be added with exclusion of air, the blue of the solution is discharged, and metallic copper is deposited as a mirror on the walls of the containing vessel, with simultaneous separation of cuprous oxide. The strength of the reducing agent may be changed by varying the quantity of the hydrazine hydrate solution added.

To show the effect of light on such a solution, twelve test tubes were fitted with corks through which pin holes had been made, and 10 cc of a solution containing 1 percent of copper

<sup>1</sup> A paper read before the Eighth International Congress of Applied Chemistry in New York, September, 1912.

acetate and 10 percent of concentrated ammonium hydroxide solution were placed in each tube. To the two sets of six tubes each, there were added respectively, 3.5, 4, 4.5, 5, 5.5, and 6 cc of a 0.5 percent solution of hydrazine hydrate. The test tubes were then corked and one set was placed in the dark while the other was exposed to the light from a 2.5 kw Macbeth carbon arc printing lamp for 7 hours. The temperature was 17° C in both cases, cold water being used to cool the tubes exposed to the arc. The first two tubes showed no reduction either in the light or in the dark. In the other four tubes exposed to the light, a reddish brown precipitate was formed which dissolved when the contents of the test tubes were shaken with air. The product was apparently chiefly cuprous oxide with perhaps a small amount of pulverulent copper, the reducing action not being strong enough to produce a copper mirror. In the corresponding four tubes which had been kept in the dark, the product was quite different both in quality and quantity. There was formed a very small amount of a muddy, blue deposit resembling a basic copper salt.

On account of the fact that this solution is colorless and that there is a simultaneous deposition of cuprous oxide, showing that the copper must be formed by the reduction of the intermediate cuprous salt, it seemed advisable to seek a stronger reducing agent which would reduce the copper sulphate solution to metallic copper direct from the blue solution. While no experiments were made to determine the effective light in the case of the ammoniacal hydrazine solution, it must have been light which is not cut off by glass.

As a stronger reducing agent, phosphorus seemed the best. R. Böttger<sup>1</sup> noticed that metallic copper was formed when phosphorus was heated with copper sulphate solution; but that the copper then reacted with more phosphorus to form copper phosphide. It was also noticed that the re-

<sup>1</sup> Jahresbericht der Chemie, 1857, 107; Jour. prakt. Chem., 70, 430 (1857); Pogg. Ann., 101, 453 (1857). See also Senderens: Comptes rendus, 104, 177 (1887).

duction went on very readily in direct sunlight, when powdered phosphorus was allowed to act on the solution absorbed by paper or cloth fiber. The substance becomes heated to about  $35^{\circ}\text{C}$ , and the rise in temperature was presumably taken for the cause of the reduction. Mrs. Fulhame<sup>1</sup> found, previous to this, that an ether solution of phosphorus reduced copper sulphate solution readily. This use of an ether solution offers the possibility of varying the reducing power by changing the phosphorus concentration of the solution. It was therefore decided to add ether solutions of phosphorus of varying concentrations to copper sulphate solutions and to allow these mixtures to stand in the dark and in the light. To prevent change of concentration as well as to exclude air, the ether solution was added under the lip of an inverted crucible which was filled with a copper sulphate solution and which stood in a crystallizing dish holding the solution. The ether solution displaced the copper sulphate solution from the inverted crucible, rising to the top, whereby volatilization was prevented and air was excluded. In order to be able to use ultraviolet light, transparent quartz crucibles were used. A mercury lamp could then be suspended over the crucibles.

A 5 percent solution of  $\text{CuSO}_4 \cdot 5\text{H}_2\text{O}$  was used. The ether solutions were made by diluting what was presumably a saturated solution of phosphorus in ether. Pieces of the element were allowed to stand in ether with intermittent shaking for several days. This solution was diluted and used, with the attempt to get the concentration such that reduction would occur in the light but not in the dark. The carbon arc printing lamp was used as the source of light.

Below are results of two parallel experiments illustrating the point at issue. One cc of the saturated phosphorus solution was diluted with ether, in one case to 10 cc and in the other case to 20 cc. Portions of these solutions, about 5 cc each, were placed over two sets of copper sulphate solution, one set being placed in the dark and the other exposed to

<sup>1</sup> "An Essay on Combustion," 60 (1794); Mellor: Jour. Phys. Chem., 7, 562 (1903).

the light from the arc. The temperature was 19.5° C. The results are given in Table I.

TABLE I—5 PERCENT COPPER SULPHATE SOLUTION, SOLUTION 30" FROM ARC. TEMP. 19.5° C

Dilution of saturated ether solution	In light	In dark
1 : 10	Phosphide after 2 hours	Phosphide after 6 hours
1 : 20	Phosphide after 6 hours	No phosphide obtained

The more dilute solution was therefore not strong enough to reduce the copper sulphate when acting alone; but reduction was accomplished when the effect due to light was superposed.

In conclusion, it may be stated that:

1. Light reduces ammoniacal copper solutions in presence of a dilute solution of hydrazine hydrate.
2. Light reduces copper sulphate solution in presence of a dilute ether solution of phosphorus.
3. The effect due to light is superposed on the effect due to the reducing agents, thereby making possible reductions which would not take place in the dark.

*Cornell University*

## NEW BOOKS

**Jacobus Henricus van't Hoff.** *By Ernst Cohen.* 17 X 24 cm. pp. xv + 638. Leipzig: Akademische Verlagsgesellschaft, 1912. Price: paper, 14.75 marks; bound, 16 marks.—This is an official biography of van't Hoff by his favorite pupil. The general facts of van't Hoff's life are by now pretty familiar to chemists. His early training was received at Delft. From there he went to the University at Leyden. In what we should call his post-graduate period, he studied with Kekulé in Bonn and with Würtz in Paris. In 1874 he received his doctor's degree in Utrecht and in 1876 he was appointed assistant at the veterinary school in Utrecht. In the autumn of 1877, van't Hoff was called to Amsterdam as instructor and, in the following year, he was made professor of chemistry, mineralogy and geology. In 1887, van't Hoff was offered the chair of physical chemistry at Leipzig, made vacant by the transfer of Gustav Wiedemann to the chair of physics. In order to keep van't Hoff from accepting this call, a new laboratory was built for him in Amsterdam, though not with great promptness, for the building was not ready for use until the autumn of 1892. In the winter of 1894-5, van't Hoff declined a call to Berlin to succeed Kundt as professor of physics. The amount of routine work at Amsterdam was so great however that, in the spring of 1895, van't Hoff presented his resignation. October of that year was spent at Weesen in Switzerland, the whole family moving to Lugano when the weather became colder. Early in 1896 van't Hoff moved to Berlin under a special arrangement with the University of Berlin and the Prussian Academy of Sciences, whereby he was required to give only such lectures as he wished to, thus giving him practically his whole time for research work. The life in Berlin proved so pleasant that, in 1902, van't Hoff refused a call to Utrecht.

The paper on asymmetric carbon atoms dates from the period before van't Hoff received his appointment at the veterinary school. During the Amsterdam period, van't Hoff did his work on chemical dynamics and chemical affinity, together with the work on the theory of solutions. In Berlin, van't Hoff devoted himself for many years to the problem of the Stassfurt salt deposits. He then turned to the question of chemical synthesis as practiced by plants; but this very important work was cut short by his death in 1911.

In the book before us, Cohen has given a charming, sympathetic, and thoroughly satisfactory picture of van't Hoff as a man and a chemist. There is an admirable series of letters between van't Hoff and Arrhenius on the subject of the electrolytic dissociation. Very interesting also are the extracts from the diary kept by van't Hoff on his first visit to America. The reviewer can supply one item which does not appear in the book. While in Newport, van't Hoff equipped himself with a butterfly net and started out to collect specimens of American butterflies to take home to one of his sons who was an enthusiastic collector. After some skirmishing, three or four different butterflies were captured and van't Hoff bore them in triumph to Mr. Agassiz to be told their names. To his great disappointment, they proved without exception to be European varieties which had been introduced into this country. Considered

as American specialties they were of no more value to an European collector than an English sparrow would be. Mention is made in the book of the dangerous drive from Ithaca to Taughannock Falls over the wrong road, but we do not find in the diary van't Hoff's characteristic remark that he was not afraid of death but that he felt that he owed it to the University of Chicago not to be killed until after he had delivered his course of lectures there.

We are indebted to the author for making accessible some of the early addresses by van't Hoff and also for his skill in arranging and presenting the many details of the scientific work carried on under van't Hoff's direction. The many illustrations also deserve a special reference. This is a worthy biography of a very great man.

*Wilder D. Bancroft*

*Tables annuelles internationales de constantes and données numériques. Vol I, 1910. 23 X 27 cm; pp. xxxix + 727. Paris: Gauthier-Villars, 1912.*

At the meeting of the seventh international congress of applied chemistry held in London in 1909, an international committee was appointed to issue annually, if possible, a volume containing the constants determined in each year. The committee received no money from the congress and have had to rely on contributions from scientific and technical societies and on the proceeds from the sale of the volumes.

The first volume, that for 1910, was issued in the spring of 1912. It contains numerical data classified as follows: coefficient of compressibility; density, viscosity; surface tension; coefficients of expansion; melting points; specific heats; thermodynamics; vapor pressures; thermal conductivity; radiation; photometry; reflecting power; emissive power; absorption coefficient; refraction and dispersion; spectroscopy; rotatory power; electricity; magnetism; radioactivity; electrons and ionization; atomic weights; atomic properties; diffusion; osmotic pressures; degree of association; mixtures (change of state); solubility; thermochemistry; chemical equilibrium; reaction velocity; conductivity of electrolytes; electromotive forces; colloids; adsorption; crystallography and mineralogy; organic chemistry; essential oils, oils, fats and waxes; animal physiology; vegetable physiology; engineering (mechanical and other properties of metals and alloys) (mechanical constants).

It is a monumental piece of work and the committee deserves to receive the support necessary to enable it to go on with the work. In some places space could have been saved profitably by a better arrangement of the tables.

*Wilder D. Bancroft*

*Ueber neuere thermodynamische Theorien. By Max Planck. 15 X 22 cm; pp. 34. Leipzig: Akademische Verlagsgesellschaft, 1912. Price: 1.50 marks.*— This is an address delivered before the German Chemical Society in Berlin last December. Planck points out that the important thing about the first law of energy is not the formal statement that the change of the total energy is equal to the sum of the work and heat added, but that the change of the energy depends only on the initial and final states in the case of a reversible change and is independent of the path. Similarly, the equation for the change of entropy should not be considered merely as a definition for the change of entropy. Its importance lies in the fact that  $\sum(Q/T) = 0$  for reversible cases.



The two laws of thermodynamics give no clue as to the absolute value of energy or entropy and the importance of Nernst's theorem lies in the assumption that the entropy of a solid or liquid substance and the specific heat at constant pressure both become zero at the absolute zero. This gives an absolute value for the entropy; but Planck is sceptical as to its being possible to determine the absolute value of the energy. Planck then discusses the Nernst theorem with special reference to Boltzmann's work and to the hypothesis as to the existence of quanta. He no longer believes that the oscillation energy of the electrons has an atomistic structure in the sense that it is always an integral multiple of a definite energy quantum.

Wilder D. Bancroft

*Handbuch der Mineralchemie.* By C. Doelter. Vol. I, Part VI. 18 × 25 cm; pp. 160. Dresden: Theodor Steinkopff, 1912. Price: 6.50 marks.—This number completes the first volume. The subjects treated are: cement; glass; glazes and enamels; slags. In the article on cement it is admitted that we are still far from a satisfactory theory of the behavior of cement. The work of the Geophysical Laboratory is admirable in that it clears away much of what was formerly believed to be true and in that it tells us what the phases actually are with which we have to deal. Though the identification of the phases is a necessary step, it is only the first step. It is to be hoped, however, that the most difficult part of the work is already done and that the rest will be relatively easy. Michaelis' colloidal theory is given, p. 884, in some detail. Either this or some modification of this seems the most promising type of theory at present.

The chapters on glass, by Zschimmer, is an admirable one. Nineteen pages are devoted to a tabulation of the compositions of different kinds of glass, and nearly thirty pages to the action of reagents on glass. The chapter on glazes and enamels—six pages—is not very satisfactory. There is nothing stimulating in it. A few formulas are given and a few empirical statements, but nothing more. On the other hand, the chapter on slags by Vogt is distinctly interesting.

Nine pages of additions and corrections follow and there is an excellent subject index.

Wilder D. Bancroft

*Refrakometrisches Hilfsbuch.* By W. A. Roth and F. Eisenlohr. 15 × 22 cm; pp. viii + 146. Leipzig: Veit & Co., 1911. Price: 6 marks.—This book is intended to be of service primarily to organic chemists. The subject is treated under the following heads: introduction; dispersion and its cause; principles of refractometry; Pulfrich's small refractometer (Wolz); Pulfrich's new model (Zeiss); special details in regard to the large Pulfrich refractometer; effect of temperature on the index of refraction of the prism; Heele's refractometer; other refractometers; differential prisms and methods; temperature regulation; sources of light; cementing the tank to the prism in the new model; pycnometers; determining the density of a liquid at different temperatures; change of density and of index of refraction with change of temperature; details in regard to molecular refraction and molecular dispersion; limits of error in determinations of densities and of indices of refraction; limits of error for molecular refraction and molecular dispersion; calculation of molecular refraction from atom refractions; abnormal cases; study of solids and of solutions. In addition there are seventeen tables exclusive of a table of five-place logarithms.

Wilder D. Bancroft

**Der energetische Imperativ.** By Wilhelm Ostwald. 17 × 23 cm; pp. 544. Leipzig: Akademische Verlagsgesellschaft, 1912. Price: 9.60 marks.—A new book by Ostwald is always welcome; but this one seems to the reviewer to be neither as easy reading nor as interesting reading as some of its predecessors. It consists of a series of essays on five subjects: philosophy, organization and internationalism, pacifism, education, and biography. Under biography we find sketches of Pierre Curie, van't Hoff, Abbe and Ramsay. There are signs of exaggeration and of hobby-riding about these sketches; but they are well worth reading for all that.

The energetic imperative, as Ostwald defines it, is that energy is to be conserved and not wasted. Whether Ostwald lives up to his own maxims is a matter of opinion. This volume contains his suggestions as to: an international organization of chemists; a universal language; an international coinage; the proper size of a printed page; universal disarmament; the setting of type; the improvement of schools; a new type of university; German script; the development of genius; the status of women; and a new calendar. No one will deny that these matters are all worth thinking about. One may also admit that Ostwald's view on these subjects are interesting; but one cannot help feeling that a man may develop a mania for reform. It seems probable that Ostwald would accomplish more if he would concentrate himself on not to exceed half a dozen reforms and should carry them through. To this extent the book is a disappointment. It is very valuable, however, as showing the workings of an active brain.

Wilder D. Bancroft

**Per-acids and their Salts.** By T. Slater Price. 15 × 22 cm; pp. vi + 123. New York: Longmans, Green & Co., 1912. Price: 3 shillings.—In the first chapter, the author says:

"In his classical researches on the Periodic System of the elements, Mendeléeff has called attention to the fact that all the oxides of the type  $RO_2$  cannot be considered as true peroxides. Some of them, as for example,  $BaO_2$ , give hydrogen peroxide with acids, and may, therefore, be considered as derivatives of that compound, while others, such as manganese dioxide,  $MnO_2$ , and lead dioxide,  $PbO_2$ , do not so react with acids. To distinguish these two classes of oxides, it is now customary to restrict the name *peroxide* to compounds of the first class, those of the second class being termed *dioxides*.

"Similarly it is necessary to distinguish between the so-called *per-acids*. True per-acids may be defined as those which are either formed by the action of hydrogen peroxide on ordinary acids, or else give rise to hydrogen peroxide on treatment with dilute sulphuric acid; with concentrated sulphuric acid many of them evolve ozonized oxygen, thus behaving similarly to the metallic peroxides and to hydrogen peroxide itself. In some cases the free acids are not known, but the same definition will apply to the formation or decomposition of their salts.

"There are other acids to which the prefix *per* has been applied, for example, perchloric, periodic, permanganic, and perruthenic acids. In the light of the above definition, however, these cannot be classed as true per-acids, since they are not formed by the action of hydrogen peroxide on the lower acids, nor is hydrogen peroxide produced by the action of dilute sulphuric acid on them

or on their salts. In their case the use of the prefix *per* denotes only that they contain relatively more oxygen than chloric, iodic, manganic, and ruthenic acids, respectively.

"Hydrogen peroxide is known to combine with many salts to form definite crystalline compounds. In many cases it is tolerably certain that the hydrogen peroxide is present in a condition analogous to that of the water in salts containing water of crystallization; such compounds are, for example,  $(\text{NH}_4)_2\text{SO}_4 \cdot \text{H}_2\text{O}_2$ ;  $\text{Na}_2\text{SO}_4 \cdot \text{H}_2\text{O}_2 \cdot \text{H}_2\text{O}$ .

"In other cases it is difficult to say whether the hydrogen peroxide is present as 'hydrogen peroxide of crystallization,' or whether it has entered into combination with the acid radical forming a per-acid. Examples of this class of compounds are those produced by the action of hydrogen peroxide on solutions of the alkali carbonates and bicarbonates, and the difficulty of characterizing them is increased by their more or less complete hydrolysis in aqueous solution, hydrogen peroxide being one of the hydrolytic products. Other compounds, which are undoubtedly per-acids, undergo a similar hydrolysis and this has caused controversy as to whether such compounds are true per-acids, or so-called molecular compounds with hydrogen peroxide as one of the molecular constituents. This question will be discussed more fully when dealing with the percarbonates, in the case of which it has been found possible to obtain a criterion distinguishing true percarbonates from carbonates containing hydrogen peroxide of crystallization. The question still remains an open one, in some cases, as, for example, with some of the compounds of boron."

It seems to the reviewer that it would have simplified matters to have pointed out that barium peroxide is apparently a compound of bivalent barium while lead dioxide is unquestionably a compound of tetravalent lead because it can be formed by the hydrolysis of any plumbic compound.

The subject is treated under the general headings: persulphates and perselenates; perborates; percarbonates; pernitric acid and perphosphoric acid; pertitanates, perzirconates and perstannates; pervanadates, percolumbates and pertantalates; perchromates; permolybdates, pertungstates and perurates.

Under persulphates the author considers only the formula  $2\text{HSO}_4' = \text{H}_2\text{S}_2\text{O}_8$  and does not mention the possible formula  $2\text{SO}_4'' + \text{H}_2\text{O} = \text{H}_2\text{S}_2\text{O}_8 + \text{O}$ . Consequently he has trouble in accounting for the increased yields when ammonium sulphate is substituted for sulphuric acid. It is only fair to say that Elbs and Schönherr calculate yields according to one formula in one part of their paper and according to the other formula in another part of the paper, without mentioning the fact that they have changed. The reviewer is not prepared to say that the reaction does not proceed in the way formulated by the author. All he claims is that the matter should have been discussed and that the author should have given his reasons for his attitude.

The field covered by this monograph is a very interesting one and the literature in regard to it is so scattered that the author has done a distinct service in getting it together and in giving us a clear account of the present state of our knowledge. The monograph is a worthy successor to the first one of the series (16, 341) on "The Chemistry of the Radio-Elements," by Soddy.

Wilder D. Bancroft

*L'analyse des vins par volumétrie physico-chimique.* By Paul Dutoit and Marcel Duboux. 15 X 22 cm; pp. 189. Lausanne: F. Rouge and Cie, 1912.—The authors point out that the electrical conductance may be used as an indicator in many cases of volumetric analysis, such as, for instance: the titration of such weak acids and bases as boric acid, phenol and pyridine; the precipitation of silver or lead halides in aqueous solution or of lead halides in alcoholic solution; the precipitation of barium sulphate in aqueous solution or of the sulphates of barium, strontium, lead, etc., in alcoholic solution; the precipitation of phosphates as uranylphosphate or the phosphates of the heavy metals; the precipitation of the chromates of lead, silver, and barium; the precipitation of calcium oxalate, barium carbonate, and silver sulphide; the precipitation of calcium, barium, strontium, magnesium, silver and lead as oxalates, sulphates, fluosilicates, chromates, etc.; the precipitation of copper, zinc, cadmium, bismuth, etc., as sulphides.

In the second part of the book the authors describe the methods for determining the various constituents in wine either by precipitation or by neutralization, using the electrical conductance as an indicator. In the last chapter are given the practical details when analyzing wines for chlorides, sulphates, phosphates, lime, tartaric acid, total acidity, total alkalinity, solids and ammonia.

The reviewer does not know to what extent these methods are better than the more orthodox ones; but the authors have done a very clever piece of work and their book opens one's eyes to new possibilities in the way of analysis.

Wilder D. Bancroft

*Lectures Delivered at the Centenary Celebration of the First Commercial Gas Co.* 15 X 22 cm; pp. 180. Easton: Chemical Publishing Co., 1912. Price: \$2.00.—In 1812 a royal charter was granted to the London and Westminster Gas Light and Coke Company. This was the first gas company formed to sell gas as an illuminant. The celebration of the hundredth anniversary of this event was held in Philadelphia last April under the auspices of the American Philosophical Society, the Franklin Institute, the American Chemical Society, and the American Gas Institute. The following lectures were delivered and are published in this volume: *By-Products in Gas Manufacture*, by Charles E. Munroe; *The Chemical and Financial Aspects of the Gas Industry*, by George B. Cortelyou; *The Technique of Gas Manufacture*, by Alfred E. Forstall; *Gas as an Illuminant*, by Van Rensselaer Lansingh; *The Use of Gas for Heat and Power, and the Testing of Gas*, by E. B. Rosa.

Wilder D. Bancroft

*Problems in Physical Chemistry.* By Edmund B. R. Prideaux. 14 X 22 cm; pp. ix + 311. New York: D. Van Nostrand Company, 1912. Price: \$2.00.—The object of this volume is to provide material for a somewhat mature course in physico-chemical calculations. The material presented is practical in nature, the desire being to familiarize the student with problems likely to be presented actually in technical as well as purely theoretical work.

Short introductory discussions of problems of like nature are given at the heads of sections, mathematical formulae, fundamental units, and some physico-chemical constants being given.

The subject matter covers: thermochemistry—heats of reaction, solution,

and dilution, radiation, and thermometry—gas problems, the phase rule, thermodynamic relations, reactions in homogeneous, and heterogeneous systems, reactions in solutions—homogeneous equilibrium, hydrolysis, migration of ions, conductivity, distribution ratio and the solubility product—electromotive force—single potentials of reactions, decomposition voltage, and overvoltage—while finally radioactivity, the order of a reaction, and the effects of rate of diffusion on reactions, are considered.

The book contains references to the original literature, making it easy to obtain a fuller discussion of the various topics.

There are some inaccuracies in the book, but as a whole it is an interesting addition to a rather meagre list of books of this character. *C. W. Bennett*

*Grundbegriffe der physikalischen Chemie.* By Professor Dr. Kurt Arndt. 12 X 17 cm; pp. 63. Berlin: Mayer and Müller, 1912. Price: 1.20 marks.

There is nothing in the preface to show what the object of this book may be; but it appears to be intended as a help to people reading for examinations. The fact that we have a third edition seems to imply that the book has found favor. On p. 20 is the statement that gels are considered to have a structure like a honeycomb. This is very likely true, but it is also said by others that gels have a structure like a sponge. The reviewer would welcome any suggestion which would enable one to distinguish between a honeycomb structure and a sponge structure in any given case. *Wilder D. Bancroft*





## NAME INDEX

### To Papers

Allen, Herman C.	The reduction of nitrobenzene by means of ferrous hydroxide, . . . . .	131
Bancroft, Wilder D.	The photographic plate, VII, VIII, . . . . .	29, 89
Bancroft, Wilder D.	The theory of emulsification, I, II, III, IV, . . . . .	177, 345, 475, 739
Bancroft, Wilder D.	Electrical endosmose, . . . . .	312
Bancroft, Wilder D.	The action of water vapor on gelatine, . . . . .	395
Bancroft, Wilder D.	The permanency of paintings, . . . . .	529
Bancroft, Wilder D.	The photochemical oxidation of benzene, . . . . .	556
Bartell, F. E.	Pore diameters of osmotic membranes, . . . . .	318
Bates, F. W.	See Lynde, C. J., . . . . .	766
Bennett, C. W.	A rotating cathode, . . . . .	287
Bennett, C. W.	Tensile strength of electrolytic copper on a rotating cathode, . . . . .	294
Bennett, C. W.	Glycerol as sensitizer, . . . . .	614
Bennett, C. W.	Photochemical reduction of copper sulphate, . . . . .	782
Elsenbast, Arthur S.	See Grant, George E., . . . . .	546
Elsenbast, Arthur S. and George E. Grant	The second positive, . . . . .	662
Farnau, E. F.	Electrolytic reduction of nitrobenzene without a diaphragm, . . . . .	249
Feldstein, M. M.	On a device for measuring transparency, . . . . .	421
Fitzgerald, F. F.	The electrical conductivity of solutions in methylamine and ethylamine, the fluidity of ammonia, methylamine, and sulphur dioxide, and the fluidity of certain solutions in these solvents, . . . . .	621
Franklin, Edward Curtis	The action of potassium amide on thallium nitrate in liquid ammonia solutions, . . . . .	682
Freer, Paul C., and H. D. Gibbs	Sunlight, . . . . .	709
Garver, M. M.	A new method of determining the range of molecular action, . . . . .	234
Garver, M. M.	On a thermodynamic measure of the degree of polymerization of liquid substances, . . . . .	454
Garver, M. M.	A note on the molecular attraction in liquids and in liquid films, . . . . .	471
Garver, M. M.	On the polymerization of liquids and a general method for determining its relative value, . . . . .	669
Garver, M. M.	A supplementary note on a thermodynamic measure of polymerization, . . . . .	679
Gibbs, H. D.	See Freer, Paul C., . . . . .	709

Grant, George E., and Arthur Eisenbast	Rapid testing of dyes and pigments, . . .	546
Grant, George E.	See Eisenbast, Arthur S., . . .	662
Heise, George W.	Equilibrium in systems consisting of lead hal- ides and pyridine, . . .	373
Hevesy, G.	On the solubility of actinium emanation in liquids and in charcoal, . . .	429
Hevesy, G.	The detection of actinium in solutions of min- erals, . . .	451
Johnson, Arden R.	A study of organic boronitrogen compounds, .	1
Kenrick, Frank B.	Some lecture experiments on surface tension, .	513
Kenrick, Frank B.	Lantern experiments on reactions in non- homogeneous systems, . . .	519
Kratz, G. D.	Colloidal ferric oxide, . . .	126
Lind, S. C.	On the nature of the chemical action produced by $\alpha$ -particles and the probable role played by ions, . . .	564
Lynde, C. J.	Osmosis in soils, I, . . .	759
Lynde, C. J., and F. W. Bates	Osmosis in soils, II, . . .	766
McCoy, Herbert N., and Franklin L. West	The physical and chemical properties of some inorganic amalgams, . . .	261
Robertson, T. Brailsford	Studies in the electrochemistry of the proteins, VIII. The dissociation of solutions of the sulphate and chloride of protamin (salmin),	382
Sargent, George J.	The decomposition of bromoform, . . .	407
Schaefer, O. C.	See Schlundt, Herman, . . .	253
Schlundt, Herman, and O. C. Schaefer	The dielectric constant of liquid arsine, . . .	253
Tyrer, D.	The theory of solubility, . . .	69
West, Franklin L.	See McCoy, Herbert N., . . .	261





## NAME INDEX

### To New Books

Abegg, R., Fr. Auerbach and R. Luther	Messungen elektromotorischen Kräfte galvanischer Ketten mit wässrigen Elektrolyten, . . .	256
Andrade, J.	Le Mouvement, . . .	428
Arndt, K.	Grundbegriffe der physikalischen Chemie, . . .	792
Avogadro, Amadeo	Opere scelte, . . .	617
Bakker, Gerritt	Théorie de la Couche capillaire plane, . . .	616
Bechhold, H.	Die Kolloide in Biologie und Medizin, . . .	426
Bigelow, S. Lawrence	Theoretical and Physical Chemistry, . . .	336
Bingham, Eugene C., and George F. White	A Laboratory Manual of Inorganic Chemistry, . . .	115
Bronn, J.	Der elektrische Ofen, . . .	257
Byers, Horace G., and Henry G. Knight	Notes on Qualitative Analysis, . . .	707
Chwolson, O. D.	Traité de Physique, Vol. I, Part 3; Vol. III, Part 2; Vol. IV, Part 1, . . .	87, 170
Cohen, Ernst	Jacobus Henricus van't Hoff, . . .	786
Curie, Mme. P.	Traité de Radioactivité, . . .	423
Curie, Mme. P.	Die Entdeckung des Radiums, . . .	708
Doelter, C.	Handbuch der Mineralchemie, Vol. I, Parts I-VI, . . .	339, 619, 788
Dutoit, Paul, and Marcel Duboux	L'Analyse des Vins par Volumétrie physico- chimique, . . .	791
Fischer, Martin H.	Nephritis, . . .	424
Fischer, Martin H.	Die Nephritis, . . .	620
Formanek, Jaroslav and Eugen Grandmougin	Untersuchung und Nachweis organischer Farbs- stoffe auf spektrochemischem Wege, . . .	428
Jones, Franklin T., and Robert Tatnall	Laboratory Problems in Physics, . . .	620
Jorissen, W. P., and L. Th. Reicher	J. H. van't Hoff's Amsterdamer Periode, . . .	707
Kayser, H.	Handbuch der Spectroscopie, Vol. IV, . . .	86
Knox, Joseph	Physico-Chemical Calculations, . . .	528
Leiser, Heinrich	Wolfram, . . .	340
Leimdorfer, J.	Beiträge zur Technologie der Seife, I, . . .	343
Leo, Max	Die Anlauffarben, . . .	174
Lüppo-Cramer, H.	Das latente Bild, . . .	617
Luther, R., and K. Drucker	Ostwald-Luther's physiko-chemische Messungen, . . .	87
Morse, Harry W.	Storage Batteries, . . .	527



Moser, Alexander	Die electrolytischen Prozesse der organischen Chemie, . . . . .	258
Nernst, W.	Traité de Chimie générale, I, II, . . . . .	172, 255
Neuner, Franz Ch.	Fortschritte in der Gerbereichemie . . . . .	260
Olsen, John C.	Pure Foods, . . . . .	175
Ostwald, Wilhelm	Ueber Katalyse, . . . . .	88
Ostwald, Wilhelm	Denkschrift über die Gründung eines internationalen Institutes für Chemie, . . . . .	259
Ostwald, Wilhelm	Monumentales unde dekoratives Pastell, . . . . .	343
Ostwald, Wilhelm	L'Évolution de l'Électrochimie, . . . . .	528
Ostwald, Wilhelm	Der energetische Imperativ, . . . . .	789
	Ostwald's Klassiker, No. 178, . . . . .	259
Partington, J. R.	Higher Mathematics for Chemical Students, . . . . .	528
Pelet-Jolivet, E.	Die Theorie des Färbeprozesses, . . . . .	174
Planck, Max	Ueber neuere thermodynamische Theorien, . . . . .	333
Plotnikow, Johannes	Photochemische Versuchstechnik, . . . . .	618
Poincaré, H.	Leçons sur les Hypothèses cosmogoniques, . . . . .	426
Prideaux, Edmund B. R.	Problems in Physical Chemistry, . . . . .	791
Price, T. Slater	Per-acids and their Salts, . . . . .	789
Pring, J. N.	Laboratory Exercises in Physical Chemistry, . . . . .	342
Ritz, Walther	Gesammelte Werke, . . . . .	428
Roberts, E.	Famous Chemists, . . . . .	260
Robertson, T. Brailsford	Die physikalische Chemie der Proteine, . . . . .	704
Roth, W. A., and F. Eisenlohr	Refractometrisches Hilfsbuch . . . . .	788
Schlotter, M.	Galvanostegie, I, II, . . . . .	258, 344
Smith, Edgar F.	Electro-Analysis, . . . . .	173
Soddy, Frederick	The Chemistry of Radio-Elements, . . . . .	341
Spencer, J. F.	An Experimental Course of Physical Chemistry, Part I, . . . . .	427
Stieglitz, Julius	The Elements of Qualitative Chemical Analysis, Vol. I, . . . . .	705
Stoddard, J. T.	Introduction to General Chemistry, . . . . .	258
Thorpe, Sir Edward	A Dictionary of Applied Chemistry, Vol. I, . . . . .	616
Wegener, Alfred	Thermodynamik der Atmosphäre, . . . . .	256





## SUBJECT INDEX

*Exclusive of New Books*

Actinium emanation, solubility of, in liquids and in charcoal, . . . . .	429
Actinium, detection of, in solutions of minerals, . . . . .	451
Action, chemical, produced by $\alpha$ particles, nature of, . . . . .	564
Action, molecular, new method of determining the range of, . . . . .	234
Action of water vapor on gelatine, . . . . .	395
Action of potassium amide on thallium nitrate in liquid ammonia solutions, . . . . .	682
Amalgams, inorganic, physical and chemical properties of some, . . . . .	261
Amide of potassium, action of, on thallium nitrate in liquid ammonia solutions, . . . . .	682
Ammonia, fluidity of, . . . . .	621
Ammonia, liquid, action of potassium amide on thallium nitrate in, . . . . .	682
Arsine, liquid, dielectric constant of, . . . . .	253
Attraction, molecular, in liquids and in liquid films, . . . . .	471
Benzene, photochemical oxidation of, . . . . .	556
Boro-nitrogen compounds, organic, study of, . . . . .	1
Bromoform, decomposition of, . . . . .	407
Cathode, rotating, . . . . .	287
Charcoal, solubility of actinium emanation in, . . . . .	429
Chemical action produced by $\alpha$ particles, nature of, . . . . .	564
Chemical and physical properties of some inorganic amalgams, . . . . .	261
Chloride of protamin, dissociation of solutions of, . . . . .	382
Colloidal ferric oxide, . . . . .	126
Compounds, organic boro-nitrogen, study of, . . . . .	1
Conductivity, electrical, of solutions in methylamine and ethylamine, . . . . .	621
Constant, dielectric, of liquid arsine, . . . . .	253
Copper, electrolytic, tensile strength of, . . . . .	294
Copper sulphate, photochemical reduction of, . . . . .	782
Decomposition of bromoform, . . . . .	407
Degree of polymerization of liquid substances, thermodynamic measure of, . . . . .	454
Detection of actinium in solutions of minerals, . . . . .	451
Device for measuring transparency, . . . . .	421
Diameters of pores of osmotic membranes, . . . . .	318
Diaphragm, electrolytic reduction of nitrobenzene without, . . . . .	249
Dielectric constant of liquid arsine, . . . . .	253
Dioxide of sulphur, fluidity of, . . . . .	621
Dissociation of solutions of the sulphate and chloride of protamin (salmin), . . . . .	382
Dyes, rapid testing of, . . . . .	546
Electrical conductivity of solutions in methylamine and ethylamine, . . . . .	621
Electrical endosmose, . . . . .	312
Electrochemistry of the proteins, studies in, . . . . .	382
Electrolytic copper, tensile strength of, . . . . .	294
Electrolytic reduction of nitrobenzene without a diaphragm, . . . . .	249
Emanation of actinium, solubility of, in liquids and in charcoal, . . . . .	429

Emulsification, theory of,	177, 345, 475, 739
Endosmose, electrical,	312
Equilibrium in systems consisting of lead halides and pyridine,	373
Ethylamine, electrical conductivity of solutions in,	621
Experiments, lantern, on reactions in non-homogeneous systems,	519
Experiments, lecture, on surface tension,	513
Ferric oxide, colloidal,	126
Ferrous hydroxide, reduction of nitrobenzene by,	131
Films, liquid, molecular attraction in,	471
Fluidity of ammonia, methylamine and sulphur dioxide,	621
Gelatine, action of water vapor on,	395
Glycerol as sensitizer,	614
Halides of lead and pyridine, equilibrium in systems consisting of,	373
Hydroxide, ferrous, reduction of nitrobenzene by,	131
Inorganic amalgams, physical and chemical properties of some,	261
Ions, probable role played by, in chemical action produced by $\alpha$ particles,	564
Lantern experiments on reactions in non-homogeneous systems,	519
Lead halides and pyridine, equilibrium in systems consisting of,	373
Lecture experiments on surface tension,	513
Liquid ammonia solutions, action of potassium on thallium nitrate in,	682
Liquid arsine, dielectric constant of,	253
Liquid films, molecular attraction in,	471
Liquids, molecular attraction in, and in liquid films,	471
Liquids, polymerization of,	669
Liquids, solubility of actinium emanation in,	429
Liquid substances, thermodynamic measure of the degree of polymerization of,	454
Measure, thermodynamic, of polymerization,	679
Measure, thermodynamic, of the degree of polymerization of liquid substances,	454
Membranes, osmotic, pore diameters of,	318
Method of determining the range of molecular action,	234
Methylamine, electrical conductivity of solutions in,	621
Methylamine, fluidity of,	621
Minerals, detection of actinium in solutions of,	451
Molecular action, new method of determining the range of,	234
Molecular attraction in liquids and in liquid films,	471
Nature of the chemical action produced by $\alpha$ particles,	564
Nitrate of thallium, action of potassium amide on, in liquid ammonia solutions,	682
Nitrobenzene, electrolytic reduction of, without a diaphragm,	249
Nitrobenzene, reduction of, by ferrous hydroxide,	131
Non-homogeneous systems, lantern experiments on reactions in,	519
Note on the molecular attraction in liquids and in liquid films,	471
Note, supplementary, on the thermodynamic measure of polymerization,	679
Organic boro-nitrogen compounds, study of,	I
Osmosis in soils,	759, 766
Osmotic membranes, pore diameters of,	318

*Subject Index*

799

Oxidation, photochemical, of benzene, . . . . .	556
Oxide, colloidal ferric, . . . . .	126
Paintings, permanency of, . . . . .	529
Particles, $\alpha$ , nature of chemical action produced by, . . . . .	564
Permanency of paintings, . . . . .	529
Photographic plate, . . . . .	29, 89
Photochemical oxidation of benzene, . . . . .	556
Photochemical reduction of copper sulphate, . . . . .	782
Physical and chemical properties of some inorganic amalgams, . . . . .	261
Pigments, rapid testing of, . . . . .	546
Plate, photographic, . . . . .	29, 89
Polymerization of liquid substances, thermodynamic measure of the de- gree of, . . . . .	454
Polymerization of liquids, . . . . .	669
Polymerization, thermodynamic measure of, . . . . .	679
Pore diameters of osmotic membranes, . . . . .	318
Positive, the second, . . . . .	662
Potassium amide, action of, on thallium nitrate in liquid ammonia solu- tions, . . . . .	682
Probable role played by ions in chemical action produced by $\alpha$ particles, . . . . .	564
Properties, physical and chemical, of some inorganic amalgams, . . . . .	261
Protamin, dissociation of solutions of the sulphate and chloride of, . . . . .	382
Proteins, studies in the electrochemistry of, . . . . .	382
Pyridine and lead halides, equilibrium in systems consisting of, . . . . .	373
Rapid testing of dyes and pigments, . . . . .	546
Reactions in non-homogeneous systems, lantern experiments on, . . . . .	519
Reduction, electrolytic, of nitrobenzene without a diaphragm, . . . . .	249
Reduction of nitrobenzene by ferrous hydroxide, . . . . .	131
Reduction, photochemical, of copper sulphate, . . . . .	782
Role, probable, played by ions in chemical action produced by $\alpha$ particles, . . . . .	564
Rotating cathode, . . . . .	287
Second positive, . . . . .	662
Sensitizer, glycerol as, . . . . .	614
Soils, osmosis in, . . . . .	759, 766
Solubility of actinium emanation in liquids and in charcoal, . . . . .	429
Solubility, theory of, . . . . .	69
Solutions in methylamine and ethylamine. electrical conductivity of, . . . . .	621
Solutions of minerals, detection of actinium in, . . . . .	451
Solutions of thallium nitrate in liquid ammonia, action of potassium amide on, . . . . .	682
Solutions of the sulphate and chloride of protamin, dissociation of, . . . . .	382
Strength, tensile, of electrolytic copper, . . . . .	294
Studies in the electrochemistry of the proteins, . . . . .	382
Study of organic boro-nitrogen compounds, . . . . .	1
Substances, liquid, thermodynamic measure of the degree of polymeriza- tion of, . . . . .	454
Sulphate of copper, photochemical reduction of, . . . . .	782
Sulphate of protamin, dissociation of solutions of, . . . . .	382

Sulphur dioxide, fluidity of, . . . . .	621
Sunlight, . . . . .	709
Supplementary note on the thermodynamic measure of polymerization, . . . . .	679
Surface tension, lecture experiments on, . . . . .	513
Systems consisting of lead halides and pyridine, . . . . .	373
Systems, non-homogeneous, lantern experiments on reactions in, . . . . .	519
Tensile strength of electrolytic copper, . . . . .	294
Tension, surface, lecture experiments on, . . . . .	513
Testing, rapid, of dyes and pigments, . . . . .	546
Thallium nitrate, action of potassium amide on, in liquid ammonia solutions, . . . . .	682
Thermodynamic measure of polymerization, . . . . .	679
Thermodynamic measure of the degree of polymerization of liquid substances, . . . . .	454
Theory of emulsification, . . . . .	177, 345, 475, 739
Theory of solubility, . . . . .	69
Transparency, device for measuring, . . . . .	421
Vapor of water, action of, on gelatine, . . . . .	395
Water vapor, action of, on gelatine, . . . . .	395

